

CATÁLOGO - TARIFA

boxtar

2021

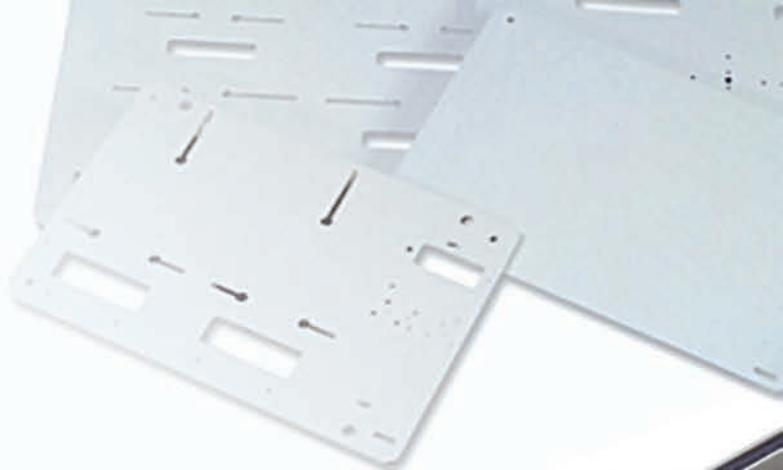
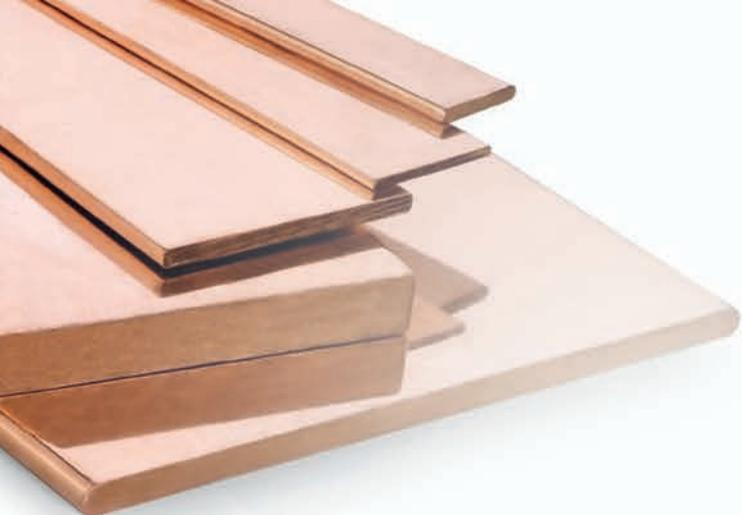

actividades eléctricas
boxtar

Nos complace presentarle la nueva TARIFA-CATÁLOGO de **ACTIVIDADES ELÉCTRICAS BOXTAR**. Este nuevo documento amplía la oferta de productos que tenemos a su disposición, manteniendo nuestro compromiso de máxima calidad de **servicio**.

Deseamos, si lo consideran oportuno, convertirnos en fieles colaboradores de su empresa, contando con un equipo humano preparado para atender sus necesidades y cuyo único objetivo es la **“satisfacción del cliente”**.

Gracias por compartir con nosotros la ilusión de este proyecto empresarial.

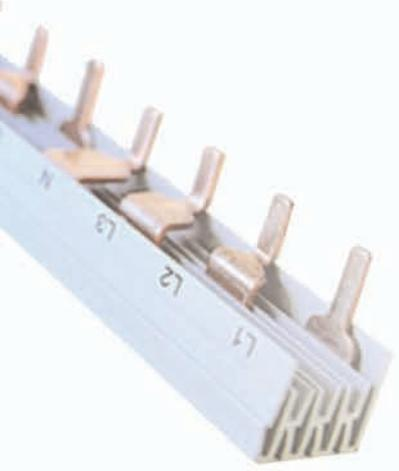

1. ACCESORIOS MONTAJE CUADROS

2 - 17

Canaleta ranurada y ciega • Fundas • Bridas • Placas de montaje • Placas de protección
Accesorios varios • Pilaretes • Tornillería • Conos pasacables • Mirillas • Ventilación

2. PLETINAS Y CONEXIONES COBRE

18 - 27

Pletina lisa • Perforada • Roscada • Conectores y bridas • Pletinas flexibles
Trenzas aisladas • Conexiones y trenzas • Puentes conectores PIA

3. ELEMENTOS DE CONEXIÓN Y DERIVACIÓN

28 - 39

Bridas de conexión • Bornas bimetálicas • Regletas y bornas • Bornas de paso • Conexión cerámica
Terminales • Grapas y petacas derivación • Aprietahilos • Punteras • Regletas y pletinas de conexión

4. REPARTIDORES Y BLOQUES DE CONEXIÓN

40 - 49

Bloques repartidores • Conjunto repartidores • Bloques repartidores gran potencia
Bloque repartidor huertos solares • Bloque unipolar potencia • Borne unipolar KVIAC

5. PUESTA TIERRA - TAPAS Y ARQUETAS DE REGISTRO

50 - 57

Placas y picas • Registros • Seccionadores • Trenzas y conexiones de cobre • Material electrosoldadura
Tapas con marco • Arquetas completas • Registro de jardín • Tapas fundición • Tapas composite

6. PERFILERÍA

58 - 61

Perfiles omega • Perfiles "C" • Escuadras • Soportes • Grapa abarcón • Tornillos fijación • Tuercas

7. ELEMENTOS AISLANTES

62 - 69

Placas aislantes • Soportes para embarrados • Aisladores • Gel aislante • Funda poliolefina
Tubo termo-retráctil • Tubo fibra de vidrio • Tubo de silicona

8. SEÑALIZACIÓN - PROTECCIÓN

70 - 75

Triángulos adhesivos y de aluminio • Señales informativas • Cinta atención • Etiquetas
Señalizadores • Portafusible NH, UTE, Neozed, BUC • Neutros • Fotovoltáica • Cajas alumbrado

9. MATERIAL DIVERSO

76 - 86

Condensadores arranque • Cajas • Conectores multipolares • Prensaestopas • Ampliaciones
Reducciones • Tuercas

10. CANALIZACIÓN - VOZ Y DATOS

87 - 101

Cadenas portacables • Minicanales • Salvacables • Canales distribución y mecanismos
Canales cubretubos • Cajas de voz y datos • Torretas • Mecanismos

11. BANDEJAS METÁLICAS Y SOPORTERÍA

102 - 119

Bandejas de rejilla • Bandejas metálicas • Accesorios • Soportería • Sistema cortafuego

12. FIJACIONES

120 - 128

Grapas fijación viga • Fijaciones rápidas • Suspensiones acero • Fijación tubos
Tacos y soportes • Grapa universal fijación

ÍNDICE DE PRODUCTOS - P.V.P. | DATOS TÉCNICOS

129 - 144

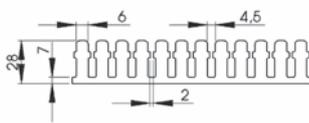
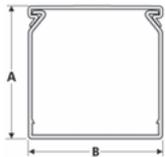
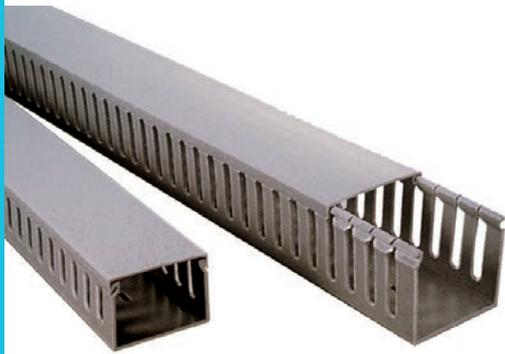

A= 30 mm

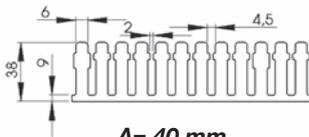

A= 40 mm

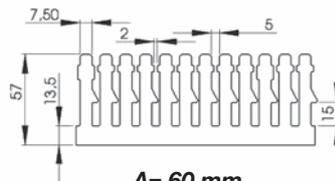

A= 60 mm

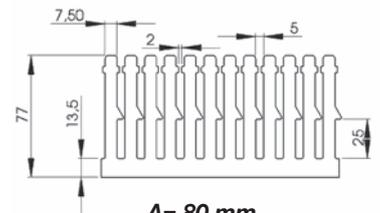

A= 80 mm



B= 25 mm



B= 40 mm

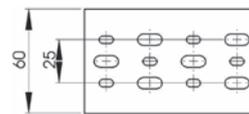

B= 60 mm

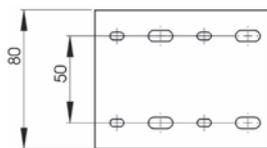

B= 80 mm

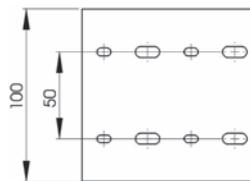

B= 100 mm

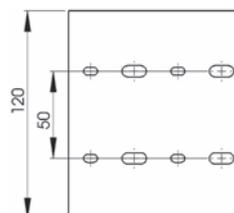

B= 120 mm

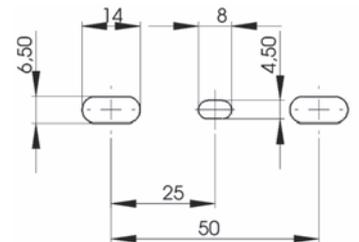

CANALETA RANURADA

CÓDIGO	EMBALAJE	DESCRIPCIÓN	A x B	€/metro
100102	60	Mts. canaleta ranurada CR-3025		4,70
100103	48	Mts. canaleta ranurada CR-4025		5,04
100104	48	Mts. canaleta ranurada CR-4040		6,43
100105	36	Mts. canaleta ranurada CR-4060		7,83
100106	32	Mts. canaleta ranurada CR-6025		7,10
100108	32	Mts. canaleta ranurada CR-6040		8,08
100109	32	Mts. canaleta ranurada CR-6060		9,16
100110	24	Mts. canaleta ranurada CR-6080		11,26
100111	16	Mts. canaleta ranurada CR-60100		15,11
100112	16	Mts. canaleta ranurada CR-60120		16,31
100113	40	Mts. canaleta ranurada CR-8025		10,01
100115	28	Mts. canaleta ranurada CR-8040		10,81
100116	20	Mts. canaleta ranurada CR-8060		11,68
100117	20	Mts. canaleta ranurada CR-8080		13,95
100118	16	Mts. canaleta ranurada CR-80100		17,61
100119	16	Mts. canaleta ranurada CR-80120		18,39

Color RAL 7030

Datos técnicos página 135

CANALETA CIEGA

CÓDIGO	EMBALAJE	DESCRIPCIÓN	A x B	€/metro
100204	48	Mts. canaleta ciega CC-4040		6,43
100205	36	Mts. canaleta ciega CC-4060		7,83
100209	32	Mts. canaleta ciega CC-6060		9,16
100210	24	Mts. canaleta ciega CC-6080		11,26
100211	16	Mts. canaleta ciega CC-60100		15,11
100212	16	Mts. canaleta ciega CC-60120		17,09

Color RAL 7030

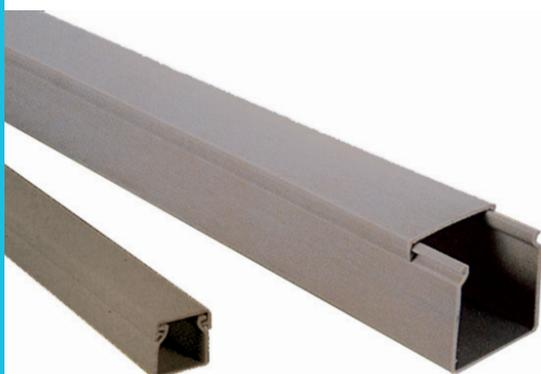

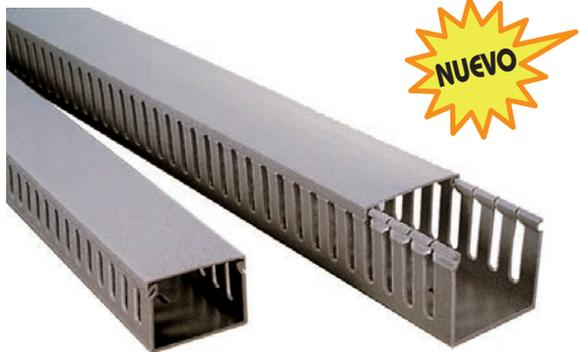

CANALETA RANURADA LIBRE DE HALÓGENOS

CÓDIGO	EMBALAJE	DESCRIPCIÓN	A x B	€/metro
100130	50	Mts. canaleta ranurada CRLH-2525		6,33
100131	48	Mts. canaleta ranurada CRLH-4025		8,05
100132	50	Mts. canaleta ranurada CRLH-4040		9,27
100133	40	Mts. canaleta ranurada CRLH-4060		13,93
100135	60	Mts. canaleta ranurada CRLH-6025		12,75
100136	40	Mts. canaleta ranurada CRLH-6040		14,13
100137	24	Mts. canaleta ranurada CRLH-6060		16,57
100141	20	Mts. canaleta ranurada CRLH-8025		15,95
100142	20	Mts. canaleta ranurada CRLH-8040		16,37
100143	20	Mts. canaleta ranurada CRLH-8060		20,70
100144	12	Mts. canaleta ranurada CRLH-8080		24,64

Color RAL 7035

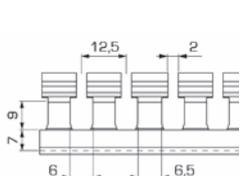
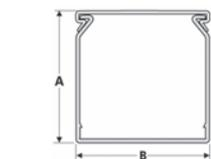

A= 25 mm

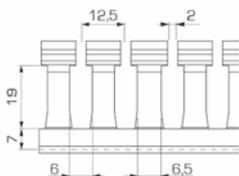

A= 40 mm

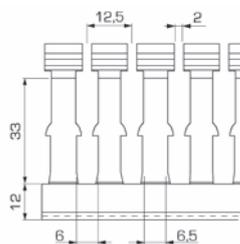

A= 60 mm

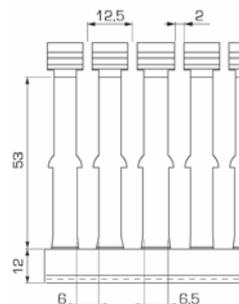

A= 80 mm



CANALETA CIEGA LIBRE DE HALÓGENOS

CÓDIGO	EMBALAJE	DESCRIPCIÓN	A x B	€/metro
100230	50	Mts. canaleta ciega CCLH-4040		13,87
100231	40	Mts. canaleta ciega CCLH-4060		18,64
100232	40	Mts. canaleta ciega CCLH-6040		20,08
100233	24	Mts. canaleta ciega CCLH-6060		23,51
100234	20	Mts. canaleta ciega CCLH-6080		28,94
100235	16	Mts. canaleta ciega CCLH-60100		34,26

Color RAL 7035

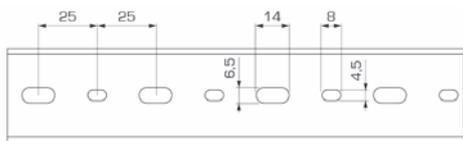

B= 25 - 40 - 60 mm

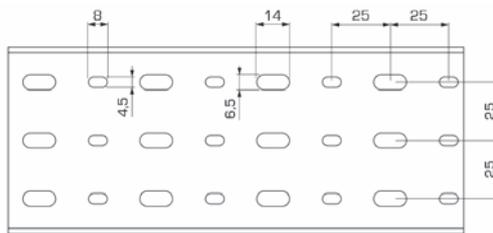

B= 80 - 100 mm

Todos los remaches sirven para cualquier canaleta

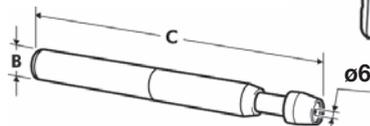
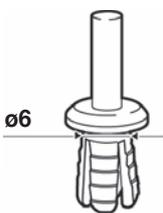

REMACHES Y HERRAMIENTAS

CÓDIGO	ENVASE EMBALAJE	DESCRIPCIÓN		€/envase		
100303	1000	Envase 1000 remaches REM-6	ø 6	316,80		
CÓDIGO	ENVASE EMBALAJE	DESCRIPCIÓN	DIMENSIONES (mm)		€/ud.	
			A	B	C	
100313	1	Herramienta remache H-6	5	14	143	49,50



FUNDA ESPIRAL

CÓDIGO	ENVASE EMBALAJE	DESCRIPCIÓN	€/metro
100401	25/500	Mts. funda espiral FEB-1 blanca	0,57
100402	25/300	Mts. funda espiral FEB-2 blanca	0,81
100403	25/300	Mts. funda espiral FEB-3 blanca	1,34
100404	25/150	Mts. funda espiral FEB-4 blanca	1,94
100405	25/150	Mts. funda espiral FEB-5 blanca	3,88
100411	25/500	Mts. funda espiral FEN-1 negra	0,69
100412	25/300	Mts. funda espiral FEN-2 negra	0,94
100413	25/300	Mts. funda espiral FEN-3 negra	1,63
100414	25/150	Mts. funda espiral FEN-4 negra	2,37
100415	25/150	Mts. funda espiral FEN-5 negra	4,58

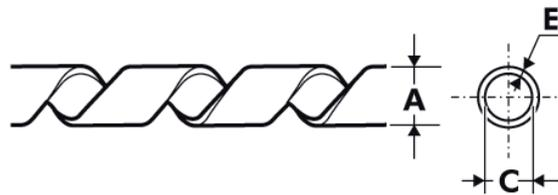

DIMENSIONES (mm)

	A	C	E
1	3,5	∅ 2,5	0,5
2	6	∅ 4	0,9
3	8	∅ 6	1,2
4	12,5	∅ 9,5	1,5
5	15	∅ 12,5	1,5

Datos técnicos página 135



FUNDA EXTENSIBLE

CÓDIGO	ENVASE EMBALAJE	DESCRIPCIÓN	∅ Min / ∅ Max.	€/metro
100501	100	Mts. funda ext. EX- 4 / 9,5 mm.		1,72
100502	50	Mts. funda ext. EX- 10 / 20 mm.		3,30
100503	25	Mts. funda ext. EX- 17 / 34 mm.		4,95
100504	25	Mts. funda ext. EX- 34 / 55 mm.		12,66

Color gris.

Datos técnicos página 135



FUNDA EXTENSIBLE REFORZADA

CÓDIGO	ENVASE EMBALAJE	DESCRIPCIÓN	∅ Min / ∅ Max.	€/metro
100511	100	Mts. funda ext. refor. REX- 4 / 17 mm.		3,97
100513	100	Mts. funda ext. refor. REX- 10 / 35 mm.		7,89
100516	50	Mts. funda ext. refor. REX- 20 / 50 mm.		24,23
100519	25	Mts. funda ext. refor. REX- 40 / 100 mm.		72,65

Color negra

Datos técnicos consultar



Datos técnicos página 136

BRIDAS BLANCAS

CÓDIGO	ENVASE EMBALAJE	DESCRIPCIÓN	Largo x ancho (mm)	€/envase
101002	100/2000	Envase 100 bridas B-100x2,5 blancas		2,30
101003	100/2000	Envase 100 bridas B-160x2,5 blancas		4,45
101004	100/2000	Envase 100 bridas B-200x2,5 blancas		4,84
101011	100/2000	Envase 100 bridas B-140x3,6 blancas		4,13
101012	100/2000	Envase 100 bridas B-200x3,5 blancas		6,68
101013	100/2000	Envase 100 bridas B-280x3,5 blancas		10,18
101021	100/2000	Envase 100 bridas B-180x4,5 blancas		6,86
101022	100/2000	Envase 100 bridas B-280x4,5 blancas		11,82
101023	100/1000	Envase 100 bridas B-360x4,5 blancas		13,91
101033	100/1000	Envase 100 bridas B-360x7,5 blancas		24,21
101042	100/100	Envase 100 bridas B-760x9,0 blancas		108,94

BRIDAS NEGRAS

CÓDIGO	ENVASE EMBALAJE	DESCRIPCIÓN	Largo x ancho (mm)	€/envase
101052	100/2000	Envase 100 bridas N-100x2,5 negras		2,30
101053	100/2000	Envase 100 bridas N-160x2,5 negras		4,45
101054	100/2000	Envase 100 bridas N-200x2,5 negras		4,84
101061	100/2000	Envase 100 bridas N-140x3,6 negras		4,13
101062	100/2000	Envase 100 bridas N-200x3,5 negras		6,68
101063	100/2000	Envase 100 bridas N-280x3,5 negras		10,18
101071	100/2000	Envase 100 bridas N-180x4,5 negras		6,86
101072	100/2000	Envase 100 bridas N-280x4,5 negras		11,82
101073	100/2000	Envase 100 bridas N-360x4,5 negras		13,91
101083	100/1000	Envase 100 bridas N-360x7,5 negras		24,21
101092	100/100	Envase 100 bridas N-760x9,0 negras		108,94



BRIDAS DETECTABLES

CÓDIGO	ENVASE EMBALAJE	DESCRIPCIÓN	€/envase
101231	100/2000	Envase 100 bridas D-100x2,5 detectables	4,40
101232	100/2000	Envase 100 bridas D-140x3,5 detectables	9,10
101233	100/2000	Envase 100 bridas D-200x4,5 detectables	15,00
101234	100/2000	Envase 100 bridas D-250x4,5 detectables	19,88
101235	100/2000	Envase 100 bridas D-280x4,5 detectables	25,81
101236	100/2000	Envase 100 bridas D-380x4,5 detectables	36,08
101237	100/1000	Envase 100 bridas D-360x7,5 detectables	78,84



Fabricadas con poliamida 6,6 a la que se añaden polvos metálicos. Son sensibles a los campos electromagnéticos. Indicadas para aplicaciones en la industria alimentaria, farmacéutica y química; usos en los que, por motivos de seguridad, los fragmentos de brida que pueden perderse entre los productos deben localizarse con un detector de metales.



BRIDAS GRISES

CÓDIGO	ENVASE EMBALAJE	DESCRIPCIÓN	Largo x ancho (mm)	€/envase
101221	100/2000	Envase 100 bridas G-140x3,6 grises		5,03
101222	100/2000	Envase 100 bridas G-188x4,8 grises		7,25
101223	100/2000	Envase 100 bridas G-280x4,8 grises		13,50

Color gris RAL 7035



TACOS NEGROS, BLANCOS Y GRISES

CÓDIGO	ENVASE EMBALAJE	DESCRIPCIÓN	Ancho max mm	€/envase
101203	100/1000	Envase 100 tacos 8 mm. planos	7,6 (1)	13,36
101202	100/5000	Envase 100 tacos 8 mm. planos grises	7,6	13,36
101207	100/2000	Envase 100 tacos 8 mm. planos blancos	7,6	13,36
101204	100/1000	Envase 100 tacos 8 mm. altos	7,6 (2)	15,28
101205	100/1000	Envase 100 tacos 8 mm. cabeza roscante	* (3)	14,31
101206	100/2000	Envase 100 tacos 8 mm. cabeza roscante grises *		14,31

Ancho max.= ancho máximo de la brida utilizable

Datos técnicos página 136



SOPORTES PARA BRIDAS

CÓDIGO	ENVASE EMBALAJE	DESCRIPCIÓN	Ancho max mm	€/envase
101209	100/1000	Envase 100 bases atornillables blancas	3,6 (1)	11,68
101210	100/1000	Envase 100 bases adhesivas 19x19 blancas	3,6 (2)	27,22
101211	100/1000	Envase 100 bases adhesivas 28x28 blancas	4,8	27,22
101212	100/1000	Envase 100 soportes roscados negros	9 (3)	12,07
101213	100/1000	Envase 100 soportes roscados grises	9	12,07

Ancho max.= ancho máximo de la brida utilizable

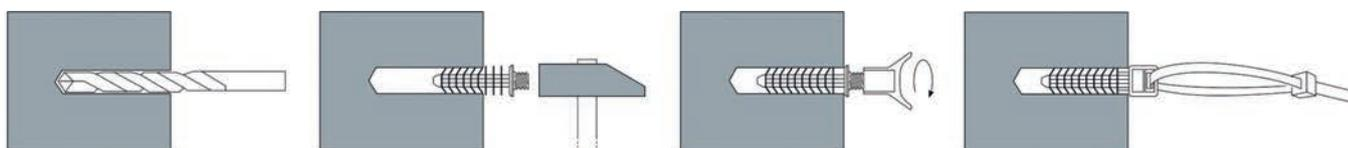

El soporte roscado se enrosca en el taco de cabeza roscante 101205 o 101206.



PLACAS DE POLIÉSTER			
CÓDIGO	ENVASE EMBALAJE	DESCRIPCIÓN	€/ud
180102	1	Placa de poliéster 1250x1020x3 mm.	134,60
180103	1	Placa de poliéster 1250x1020x4 mm.	177,42
180104	1	Placa de poliéster 1250x1020x5 mm.	225,44
180105	1	Placa de poliéster 1250x1020x6 mm.	250,94

Poliéster reforzado con fibra de vidrio. Color gris RAL 7035
Consultar disponibilidad de otros espesores



PLACAS DE BAQUELITA ANTI-TRACKING			
CÓDIGO	ENVASE EMBALAJE	DESCRIPCIÓN	€/ud
180173	1	Placa baq. reforz. 1300x930x3 mm. gris	178,10
180174	1	Placa baq. reforz. 1300x930x4 mm. gris	233,54
180175	1	Placa baq. reforz. 1300x930x5 mm. gris	292,80
180176	1	Placa baq. reforz. 1300x930x6 mm. gris	355,72
180178	1	Placa baq. reforz. 1300x930x8 mm. gris	468,66
180180	1	Placa baq. reforz. 1300x930x10 mm. gris	592,60

La capa anti-tracking protege a la placa contra el arco eléctrico



PLACAS DE POLICARBONATO TRANSPARENTE U.V.			
CÓDIGO	ENVASE EMBALAJE	DESCRIPCIÓN	€/ud
180251	1	Placa Policarbonato 2050x1525x2 mm.	552,98
180252	1	Placa Policarbonato 2050x1525x3 mm.	761,44
180253	1	Placa Policarbonato 2050x1525x4 mm.	866,77
180254	1	Placa Policarbonato 2050x1525x5 mm.	1.080,75

Consultar embalajes para el suministro de placas enteras

PLACAS DE PROTECCIÓN



PLACAS DE EMBARRADO ESTÁNDAR				
CÓDIGO	ENVASE EMBALAJE	DESCRIPCIÓN	DIMENSIONES (mm)	€/ud
180205	5	Placa embarrado transp. 595x250x2 mm.		15,73
180206	5	Placa embarrado transp. 595x370x2 mm.		18,15

Protecciones BUC página 73

FABRICACIÓN A MEDIDA DE PLACAS DE PROTECCIÓN MECANIZADAS Y PLEGADAS DE MATERIALES TERMOPLÁSTICOS



PLACAS LISAS PINAZO-CAHORS-HIMEL

CÓDIGO	ENVASE EMBALAJE	DESCRIPCIÓN	€/ud
181201	10	Placa lisa 4215	1,73
181202	10	Placa lisa 4315	2,44
181203	10	Placa lisa 432-1827	3,33
181204	10	Placa lisa 433-2727	4,01
181205	10	Placa lisa 434-2736	5,06
181206	10	Placa lisa 444-3636	7,85
181207	10	Placa lisa 463-2754	7,97
181208	5	Placa lisa 464-3654	10,22
181209	5	Placa lisa 466-5454	20,63
181210	5	Placa lisa 484-3672	18,71
181211	5	Placa lisa 486-5472	26,75

PLACAS MECANIZADAS PINAZO-CAHORS-HIMEL

CÓDIGO	ENVASE EMBALAJE	DESCRIPCIÓN	€/ud
191306	10	Placa 433-1M Desp.	7,05
191307	10	Placa 433 -1M	7,05
191311	10	Placa 434 -1T	8,32
191312	10	Placa 434-1M Desp.	8,32
191313	10	Placa 434-2M	8,52
191321	10	Placa 463-1T	11,71
191322	10	Placa 463-3M	14,91
191326	5	Placa 464-3T	20,10
191332	5	Placa 466-6M	37,34

PLACAS LISAS DOBLE AISLAMIENTO

CÓDIGO	ENVASE EMBALAJE	DESCRIPCIÓN	€/ud
181281	10	Placa lisa 00	10,66
181283	10	Placa lisa 0	11,39
181285	5	Placa lisa 1	17,30
181286	5	Placa lisa 2	23,96
191990	10	Placa supletoria Monofásico	6,05
191994	10	Placa supletoria Trifásico	9,68

PLACAS LISAS Y MECANIZADAS CAHORS

CÓDIGO	ENVASE EMBALAJE	DESCRIPCIÓN	€/ud
181231	10	Placa lisa 3530	5,86
181232	10	Placa lisa 3540	7,97
181233	10	Placa lisa 3545	9,30
181234	10	Placa lisa 7030	9,53
181235	5	Placa lisa 7040	13,03
181236	5	Placa lisa 7045	17,64
181237	5	Placa lisa 7060	22,23
191403	10	Placa 3530-1M	8,12
191404	10	Placa 3540-2M	8,65
191408	10	Placa 3545-1T	12,11
191411	10	Placa 7030-4M	17,57
191422	5	Placa 7045-3T	22,36

PLACAS LISAS Y MECANIZADAS CLAVED

CÓDIGO	ENVASE EMBALAJE	DESCRIPCIÓN	€/ud
181251	10	Placa lisa 22	4,01
181252	10	Placa lisa 23	5,06
181253	10	Placa lisa 25	7,97
181254	5	Placa lisa 35	10,22
181255	5	Placa lisa 55	20,64
191503	10	Placa C22-1M Desp	7,05
191504	10	Placa C22-1M	7,05
191515	10	Placa C33-1MT	13,18
191518	10	Placa C25-1MT	11,71
191531	5	Placa C27-5M	17,17
191523	5	Placa C37-4T	17,97



CASQUILLOS AISLANTES

CÓDIGO	ENVASE EMBALAJE	DESCRIPCIÓN	€/ud
200202	1000	Casquillo aislante CA-10	0,19
200203	500	Casquillo aislante CA-15	0,24
200205	500	Casquillo aislante CA-20	0,28
200209	200	Casquillo aislante CA-40	0,43

*Las placas mecanizadas se suministran sin accesorios de fijación de contador
Mecanizado a medida de placas de montaje de poliéster*

1



2

SUJECIÓN DE CONTADORES

CÓDIGO	ENVASE EMBALAJE	DESCRIPCIÓN		€/ud
200101	25	Juego contador estándar	(1)	1,51
200102	25	Juego contador latón	(2)	3,27

NUEVO

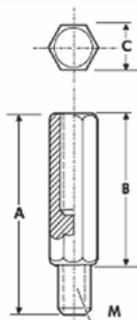
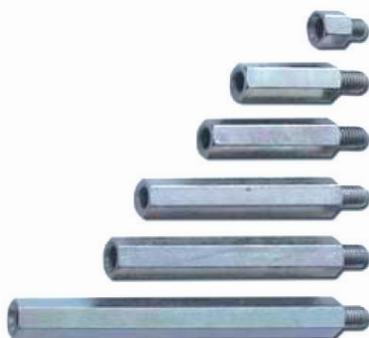

PILARETES ELEVADORES METÁLICOS

CÓDIGO	ENVASE EMBALAJE	DESCRIPCIÓN	mm.			MÉTRICA	€/ud
			A	B	C		
200331	50	Pilarete metálico PEM-15/5	23	15	8	M5	1,64
200332	50	Pilarete metálico PEM-20/5	28	20	8	M5	1,92
200334	50	Pilarete metálico PEM-30/5	38	30	8	M5	2,20
200336	25	Pilarete metálico PEM-40/5	48	40	8	M5	2,36
200337	25	Pilarete metálico PEM-50/5	58	50	8	M5	2,48
200338	25	Pilarete metálico PEM-60/5	68	60	8	M5	3,16
200339	25	Pilarete metálico PEM-70/5	78	70	8	M5	3,56
200340	25	Pilarete metálico PEM-80/5	88	80	8	M5	4,72
200301	100	Pilarete metálico PEM-10/6	20	10	9	M6	0,81
200302	100	Pilarete metálico PEM-15/6	25	15	9	M6	0,86
200303	100	Pilarete metálico PEM-20/6	30	20	9	M6	0,96
200304	100	Pilarete metálico PEM-30/6	40	30	9	M6	1,10
200305	100	Pilarete metálico PEM-40/6	50	40	9	M6	1,14
200306	100	Pilarete metálico PEM-50/6	60	50	9	M6	1,32
200307	50	Pilarete metálico PEM-60/6	70	60	9	M6	1,40
200308	50	Pilarete metálico PEM-70/6	80	70	9	M6	1,58
200309	50	Pilarete metálico PEM-80/6	90	80	9	M6	1,65
200310	50	Pilarete metálico PEM-90/6	100	90	9	M6	1,87
200311	50	Pilarete metálico PEM-100/6	110	100	9	M6	2,12
200313	100	Pilarete metálico PEM-15/8	25	15	12	M8	2,35
200314	100	Pilarete metálico PEM-20/8	30	20	12	M8	2,56
200315	50	Pilarete metálico PEM-30/8	40	30	12	M8	2,78
200316	50	Pilarete metálico PEM-40/8	50	40	12	M8	3,02
200317	50	Pilarete metálico PEM-50/8	60	50	12	M8	3,20
200326	25	Pilarete metálico PEM-100/8	110	100	12	M8	6,89



1

2

3

PILARETES ELEVADORES Y TUERCAS AISLANTES

CÓDIGO	ENVASE EMBALAJE	DESCRIPCIÓN		€/ud
200351	50	Pilarete aislante PEA-15/6		3,64
200352	50	Pilarete aislante PEA-20/6		3,74
200353	25	Pilarete aislante PEA-30/6		3,94
200354	25	Pilarete aislante PEA-45/6		4,45
200355	25	Pilarete aislante PEA-70/6		4,82
200356	25	Pilarete aislante PEA-120/6		5,20
200371	100	Tuerca aislante	(1)	0,89
200372	100	Tuerca inserto latón	(2)	2,10
200373	100	Tuerca con espárrago	(3)	1,99

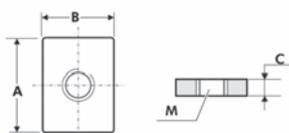

TUERCAS CUADRADAS Y RECTANGULARES

CÓDIGO	ENVASE EMBALAJE	DESCRIPCIÓN	Dimensiones (mm)			€/envase
			A	B	C	
270802	100	Envase 100 tuercas cuadradas M5	19	16	3	31,95
270803	100	Envase 100 tuercas cuadradas M6	18	16	3	34,46
270804	100	Envase 100 tuercas rectangulares M6	36	16	3	39,98
270805	100	Envase 100 tuercas rectangulares M8	36	20	4	91,71

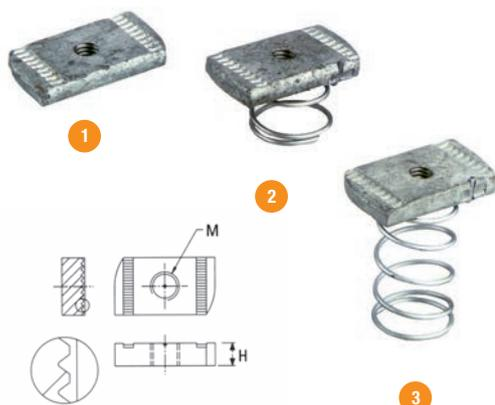

TUERCAS REFORZADAS

CÓDIGO	ENVASE EMBALAJE	DESCRIPCIÓN	€/ud
270901	100	Tuerca reforzada M6	3,01
270902	100	Tuerca reforzada M8 (1)	3,09
270903	100	Tuerca reforzada M10	3,22
270904	100	Tuerca reforzada muelle corto M6 H5	3,16
270905	100	Tuerca reforzada muelle corto M8 H6 (2)	3,32
270906	100	Tuerca reforzada muelle corto M10 H8	3,62
270907	100	Tuerca reforzada muelle largo M6 H5	3,21
270908	100	Tuerca reforzada muelle largo M8 H6 (3)	3,32
270909	100	Tuerca reforzada muelle largo M10 H8	3,40

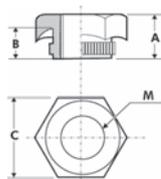

TUERCAS INSERTABLES

CÓDIGO	ENVASE EMBALAJE	DESCRIPCIÓN	Dimensiones (mm)			€/envase
			A	B	C	
200651	100	Envase 100 tuercas insertables M4	5	3	7	49,15
200652	100	Envase 100 tuercas insertables M5	5,5	3,5	8	53,25
200653	100	Envase 100 tuercas insertables M6	6	4	10	55,79
200654	100	Envase 100 tuercas insertables M8	7	4,5	13	86,34
200655	100	Envase 100 tuercas insertables M10	7,5	5	17	153,47

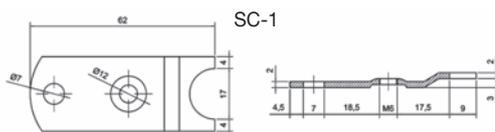

SUJECIÓN CAJAS

CÓDIGO	ENVASE EMBALAJE	DESCRIPCIÓN	€/ud
200901	50	Sujeción cajas SC-1	1,55

BISAGRAS

CÓDIGO	ENVASE EMBALAJE	DESCRIPCIÓN	€/ud
200912	10	Juego bisagra aislante	10,09
200914	50	Bisagra metálica 16	8,12

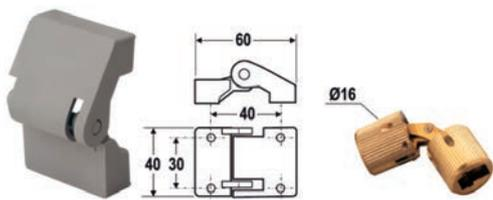



TORNILLERÍA DIN 7985

CÓDIGO	ENVASE EMBALAJE	DESCRIPCIÓN	€/envase
200412	100	Envase 100 tornillos DIN 7985 4x10	7,30
200414	100	Envase 100 tornillos DIN 7985 4x15	8,77
200416	100	Envase 100 tornillos DIN 7985 4x20	10,07
200417	100	Envase 100 tornillos DIN 7985 4x25	10,52
200418	100	Envase 100 tornillos DIN 7985 4x30	11,18
200419	100	Envase 100 tornillos DIN 7985 4x35	11,98
200420	100	Envase 100 tornillos DIN 7985 4x40	12,57
200426	100	Envase 100 tornillos DIN 7985 5x10	8,62
200428	100	Envase 100 tornillos DIN 7985 5x15	10,23
200430	100	Envase 100 tornillos DIN 7985 5x20	10,67
200431	100	Envase 100 tornillos DIN 7985 5x25	11,11
200432	100	Envase 100 tornillos DIN 7985 5x30	11,98
200433	100	Envase 100 tornillos DIN 7985 5x35	13,44
200434	100	Envase 100 tornillos DIN 7985 5x40	14,61
200435	100	Envase 100 tornillos DIN 7985 5x45	17,38
200441	100	Envase 100 tornillos DIN 7985 6x10	12,40
200443	100	Envase 100 tornillos DIN 7985 6x15	13,29
200445	100	Envase 100 tornillos DIN 7985 6x20	14,02
200446	100	Envase 100 tornillos DIN 7985 6x25	14,90
200447	100	Envase 100 tornillos DIN 7985 6x30	15,64
200448	100	Envase 100 tornillos DIN 7985 6x35	19,00
200449	100	Envase 100 tornillos DIN 7985 6x40	20,46
200450	100	Envase 100 tornillos DIN 7985 6x45	23,38
200451	100	Envase 100 tornillos DIN 7985 6x50	29,23



TORNILLERÍA DIN 84

CÓDIGO	ENVASE EMBALAJE	DESCRIPCIÓN	€/envase
200461	100	Envase 100 tornillos DIN 84 4x10	7,37
200463	100	Envase 100 tornillos DIN 84 4x15	8,79
200465	100	Envase 100 tornillos DIN 84 4x20	10,16
200466	100	Envase 100 tornillos DIN 84 4x25	10,61
200467	100	Envase 100 tornillos DIN 84 4x30	11,62
200468	100	Envase 100 tornillos DIN 84 4x35	12,06
200469	100	Envase 100 tornillos DIN 84 4x40	12,68
200471	100	Envase 100 tornillos DIN 84 5x10	8,70
200473	100	Envase 100 tornillos DIN 84 5x15	10,31
200475	100	Envase 100 tornillos DIN 84 5x20	10,76
200476	100	Envase 100 tornillos DIN 84 5x25	11,20
200477	100	Envase 100 tornillos DIN 84 5x30	12,08
200478	100	Envase 100 tornillos DIN 84 5x35	13,56
200479	100	Envase 100 tornillos DIN 84 5x40	14,74
200480	100	Envase 100 tornillos DIN 84 5x45	17,54
200481	100	Envase 100 tornillos DIN 84 6x10	12,53
200483	100	Envase 100 tornillos DIN 84 6x15	13,42
200485	100	Envase 100 tornillos DIN 84 6x20	14,15
200486	100	Envase 100 tornillos DIN 84 6x25	15,03
200487	100	Envase 100 tornillos DIN 84 6x30	15,77
200488	100	Envase 100 tornillos DIN 84 6x35	19,16
200489	100	Envase 100 tornillos DIN 84 6x40	20,63
200490	100	Envase 100 tornillos DIN 84 6x45	23,59
200491	100	Envase 100 tornillos DIN 84 6x50	29,48



TORNILLERÍA DIN 933

CÓDIGO	ENVASE EMBALAJE	DESCRIPCIÓN	€/envase
200511	100	Envase 100 tornillos DIN 933 5x10	9,78
200513	100	Envase 100 tornillos DIN 933 5x15	10,38
200515	100	Envase 100 tornillos DIN 933 5x20	10,95
200516	100	Envase 100 tornillos DIN 933 5x25	11,26
200517	100	Envase 100 tornillos DIN 933 5x30	11,99
200518	100	Envase 100 tornillos DIN 933 5x35	12,86
200519	100	Envase 100 tornillos DIN 933 5x40	13,58
200526	100	Envase 100 tornillos DIN 933 6x10	13,16
200528	100	Envase 100 tornillos DIN 933 6x15	13,58
200530	100	Envase 100 tornillos DIN 933 6x20	14,17
200531	100	Envase 100 tornillos DIN 933 6x25	14,46
200532	100	Envase 100 tornillos DIN 933 6x30	15,05
200533	100	Envase 100 tornillos DIN 933 6x35	15,35
200534	100	Envase 100 tornillos DIN 933 6x40	17,53
200535	100	Envase 100 tornillos DIN 933 6x45	19,00
200536	100	Envase 100 tornillos DIN 933 6x50	20,46
200541	100	Envase 100 tornillos DIN 933 8x10	20,17
200543	100	Envase 100 tornillos DIN 933 8x15	21,19
200545	100	Envase 100 tornillos DIN 933 8x20	23,23
200546	100	Envase 100 tornillos DIN 933 8x25	24,54
200547	100	Envase 100 tornillos DIN 933 8x30	27,63
200548	100	Envase 100 tornillos DIN 933 8x35	30,68
200549	100	Envase 100 tornillos DIN 933 8x40	33,61
200550	100	Envase 100 tornillos DIN 933 8x45	37,99
200551	100	Envase 100 tornillos DIN 933 8x50	42,38



TORNILLERÍA AISLANTE

CÓDIGO	ENVASE EMBALAJE	DESCRIPCIÓN	€/envase
200715	100	Envase 100 tornillos aislantes 5x20	20,69
200716	100	Envase 100 tornillos aislantes 5x30	22,00
200718	100	Envase 100 tornillos aislantes 6x20	22,01
200719	100	Envase 100 tornillos aislantes 6x30	23,48
200743	100	Envase 100 tuercas aislantes M5	25,21
200744	100	Envase 100 tuercas aislantes M6	26,68



VARILLAS ROSCADAS

CÓDIGO	ENVASE EMBALAJE	DESCRIPCIÓN	€/ud
200703	10	Varilla roscada M6 longitud 1m.	5,08
200704	10	Varilla roscada M8 longitud 1m.	6,99
200705	10	Varilla roscada M10 longitud 1m.	10,16



CONECTORES Y TACOS PARA VARILLAS

CÓDIGO	ENVASE EMBALAJE	DESCRIPCIÓN	€/envase
200752	100	Envase 100 conectores varilla M6x30	49,22
200753	100	Envase 100 conectores varilla M8x30 (1)	56,84
200754	100	Envase 100 conectores varilla M10x30	80,04
130802	100	Envase 100 tacos hembra M6	25,41
130803	100	Envase 100 tacos hembra M8 (2)	35,57
130804	100	Envase 100 tacos hembra M10	59,71



TUERCAS Y ARANDELAS PLANAS, DENTADAS Y GROWER

CÓDIGO	ENVASE EMBALAJE	DESCRIPCIÓN	€/envase
200602	100	Envase 100 tuercas DIN 934 M4	5,04
200603	100	Envase 100 tuercas DIN 934 M5	5,95
200604	100	Envase 100 tuercas DIN 934 M6	7,46
200605	100	Envase 100 tuercas DIN 934 M8	10,52
200606	100	Envase 100 tuercas DIN 934 M10	16,92
200607	100	Envase 100 tuercas DIN 934 M12	23,63
200612	100	Envase 100 arandelas planas DIN 125 M4	3,67
200613	100	Envase 100 arandelas planas DIN 125 M5	4,42
200614	100	Envase 100 arandelas planas DIN 125 M6	5,34
200615	100	Envase 100 arandelas planas DIN 125 M8	7,32
200616	100	Envase 100 arandelas planas DIN 125 M10	9,15
200617	100	Envase 100 arandelas planas DIN 125 M12	15,08
200640	100	Envase 100 arandelas planas DIN 9021 M4 ZN	10,34
200641	100	Envase 100 arandelas planas DIN 9021 M5 ZN	12,28
200642	100	Envase 100 arandelas planas DIN 9021 M6 ZN	12,81
200643	100	Envase 100 arandelas planas DIN 9021 M8 ZN	13,33
200644	100	Envase 100 arandelas planas DIN 9021 M10 ZN	14,37
200639	100	Envase 100 arandelas planas DIN 9021 M12 ZN	16,13
200622	100	Envase 100 arandelas dentadas DIN 6798A M4	5,19
200623	100	Envase 100 arandelas dentadas DIN 6798A M5	5,96
200624	100	Envase 100 arandelas dentadas DIN 6798A M6	7,32
200625	100	Envase 100 arandelas dentadas DIN 6798A M8	10,52
200626	100	Envase 100 arandelas dentadas DIN 6798A M10	15,10
200627	100	Envase 100 arandelas dentadas DIN 6798A M12	21,36
200632	100	Envase 100 arandelas grower DIN 7980 M4	4,57
200633	100	Envase 100 arandelas grower DIN 7980 M5	5,64
200634	100	Envase 100 arandelas grower DIN 7980 M6	7,32
200635	100	Envase 100 arandelas grower DIN 7980 M8	8,39
200636	100	Envase 100 arandelas grower DIN 7980 M10	10,52
200637	100	Envase 100 arandelas grower DIN 7980 M12	12,20
200645	100	Envase 100 arandelas NFE 25511 M4	8,18
200646	100	Envase 100 arandelas NFE 25511 M5	9,56
200647	100	Envase 100 arandelas NFE 25511 M6	11,24
200648	100	Envase 100 arandelas NFE 25511 M8	16,70
200649	100	Envase 100 arandelas NFE 25511 M10	26,48
200660	100	Envase 100 tuerca brida DIN 6923 M4	5,78
200661	100	Envase 100 tuerca brida DIN 6923 M5	6,98
200662	100	Envase 100 tuerca brida DIN 6923 M6	8,06
200663	100	Envase 100 tuerca brida DIN 6923 M8	13,58
200664	100	Envase 100 tuerca brida DIN 6923 M10	22,16
200665	100	Envase 100 tuerca brida DIN 6923 M12	36,62

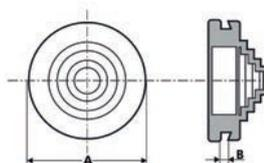
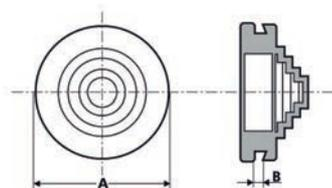
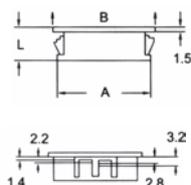

PASACABLES ABIERTOS

CÓDIGO	EMBALAJE	DESCRIPCIÓN	Dimensiones		€/ud
			A	B	
201151	50	Pasacable abiertos CPB-16	15,9	18,3	0,28
201152	50	Pasacable abiertos CPB-19	19	21,8	0,30
201153	100	Pasacable abiertos CPB-21	20,6	22,6	0,33
201154	100	Pasacable abiertos CPB-22	22,2	23,8	0,34
201155	100	Pasacable abiertos CPB-25	25,3	28,5	0,40
201156	100	Pasacable abiertos CPB-28	27,6	30,8	0,46
201157	50	Pasacable abiertos CPB-35	34,2	37,5	0,58

CONOS PASACABLES Y CONOS ECO

CÓDIGO	EMBALAJE	DESCRIPCIÓN	Dimensiones			€/ud
			A	B	ø	
201101	100	Cono pasacables CP-19	28	3,5	22	0,53
201102	50	Cono pasacables CP-28	36	3,5	31	0,69
201103	50	Cono pasacables CP-38	41	3,5	41	1,04
201104	50	Cono pasacables CP-47	55	3,5	50	1,41
201105	50	Cono pasacables CP-64	72	3,5	68	1,94
201106	20	Cono pasacables CP-90	110	3,5	96	4,10
201112	50	Cono pasacables CPE-29 ECO	41	3	29	0,48
201113	50	Cono pasacables CPE-40 ECO	54	3	40	0,78
201114	25	Cono pasacables CPE-52 ECO	59	3	52	1,10

CONOS PASACABLES AJUSTABLES

CÓDIGO	EMBALAJE	DESCRIPCIÓN	Dimensiones		€/ud
			A	B	
201121	50	Cono pasacables ajustable CPA-21	24	3	0,59
201122	50	Cono pasacables ajustable CPA-28	34	3	0,68
201123	50	Cono pasacables ajustable CPA-38	40	3	0,73
201124	20	Cono pasacables ajustable CPA-48	54	3	0,87

ACOPLAMIENTOS CAJAS

CÓDIGO	EMBALAJE	DESCRIPCIÓN	€/ud
201002	15	Acoplamiento cajas A-M para CAH-PNZ	5,09
201003	10	Acoplamiento cajas A-G para CAH-PNZ	6,89
201008	15	Acoplamiento con junta AJ-M para CAH-PNZ	10,69
201009	10	Acoplamiento con junta AJ-G para CAH-PNZ	13,31

M= Abertura 270 mm. / G= Abertura 360 mm.

TAPAS DE CIERRE

CÓDIGO	EMBALAJE	DESCRIPCIÓN	€/ud
201021	25	Tapa de cierre TC-M Abertura 270 mm.	10,16
201022	20	Tapa de cierre TC-G Abertura 360 mm.	13,08
201026	20	Tapa de cierre con junta TCJ-M Abertura 270 mm.	13,67
201027	12	Tapa de cierre con junta TCJ-G Abertura 360 mm.	16,74

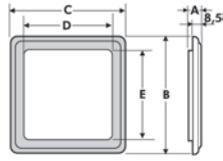

MIRILLAS FIJAS

CÓDIGO	EMBALAJE	DESCRIPCIÓN	DIMENSIONES mm					€/ud
			A	B	C	D	E	
201201	30	Mirilla fija MF-12	12	120	120	90	90	9,64

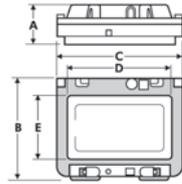

MIRILLAS ABATIBLES

CÓDIGO	EMBALAJE	DESCRIPCIÓN	DIMENSIONES mm					€/ud
			A	B	C	D	E	
201402	30	Mirilla abatible MAA-4	30	77	94	78	50	13,36
201403	20	Mirilla abatible MAA-6	30	77	130	114	50	16,00
201404	20	Mirilla abatible MAA-8	30	77	164	147	50	17,51
201405	30	Mirilla abatible MAA-10	30	77	202	182	50	20,32
201406	25	Mirilla abatible MAA-12	30	77	235	217	50	23,38

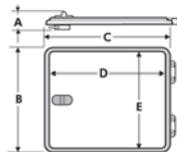

MIRILLAS ARTICULADAS

CÓDIGO	EMBALAJE	DESCRIPCIÓN	DIMENSIONES mm					€/ud
			A	B	C	D	E	
201501	20	Mirilla artic. MAR-16	20	125	165	140	100	24,49
201502	10	Mirilla artic. MAR-24	31	196	249	215	178	27,55

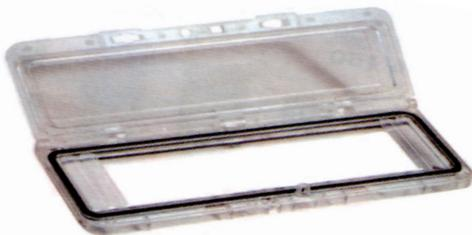

MIRILLA UNIÓN FENOSA

CÓDIGO	EMBALAJE	DESCRIPCIÓN	DIMENSIONES mm	€/ud
201416	30	Mirilla Unión Fenosa MUF	584x209	58,09

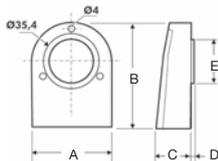
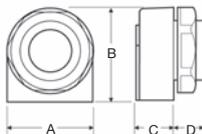

DISPOSITIVOS VENTILACIÓN

CÓDIGO	EMBALAJE	DESCRIPCIÓN	DIMENSIONES mm					€/ud
			A	B	C	D	E	
201801	50	Dispositivo Vent. DV-P	25	28	12	9	19	2,05
201802	10	Dispositivo Vent. DV-G	50,5	69	12	1,5	29	4,33



DISPOSITIVOS EXTRACCIÓN (FRICCIÓN)

CÓDIGO	ENVASE EMBALAJE	DESCRIPCIÓN	€/ud
201901	4	Extractor E-80x38/220V	30,90
201902	3	Extractor E-92x25/220V	31,90
201903	8	Extractor E-120x38/220V	32,90
201943	8	Extractor E-120/220V 5W bajo consumo	32,90
201931	8	Extractor E-80x25/12V DC	35,00
201932	8	Extractor E-80x25/24V DC	35,00
201936	10	Extractor E-92x25/12V DC	35,00
201937	10	Extractor E-92x25/24V DC	35,00
201933	4	Extractor E-120x25/12V DC	40,00
201934	4	Extractor E-120x25/24V DC	40,00
201938	8	Extractor E-80x38/24V AC	35,00
201935	8	Extractor E-120x38/24V AC	40,00



DISPOSITIVOS EXTRACCIÓN (METAL-BOLAS)

CÓDIGO	ENVASE EMBALAJE	DESCRIPCIÓN	€/ud
201950	8	Extractor EB-80x38/220V	50,00
201951	8	Extractor EB-92x38/220V	51,00
201952	8	Extractor EB-120x38/220V	55,00
201953	4	Extractor EB-162x55/220V	80,00
201954	2	Extractor EB-225x80/220V	160,00

DISPOSITIVOS EXTRACCIÓN (RODAM. BOLAS)

CÓDIGO	ENVASE EMBALAJE	DESCRIPCIÓN	€/ud
201904	1	Extractor EB-175x51/220V	63,00
201905	2	Extractor EB-175x38/220V	63,00



CONJUNTO DE EXTRACCIÓN

CÓDIGO	ENVASE EMBALAJE	DESCRIPCIÓN	€/ud
201960	1	Conjunto CE-92/220V rodam. bolas + RFP + RJM	39,99
201961	1	Conjunto CE-120/220V rodam. bolas + RFP + RJM	45,80
201962	1	Conjunto CE-175/220V rodam. bolas + RFP + RJM	78,60

Conjunto de extracción compuesto por:

- Extractor rodamientos bolas
- Rejilla persiana gris
- Rejilla metálica



CONJUNTO DE EXTRACCIÓN TIPO CAMPANA

CÓDIGO	ENVASE EMBALAJE	DESCRIPCIÓN	€/ud
201963	1	Conjunto CE-175/220V rodam. bolas + adaptador + RFP + RJM	89,75
201964	1	Conjunto CE-225/220V rodam. bolas + adaptador + RFP + RJM	176,20



1



2



3



4



4



5



6



REJILLAS Y CABLE CONEXIÓN

CÓDIGO	ENVASE EMBALAJE	DESCRIPCIÓN	€/ud
201906	15	Rejilla Filtro RF-80 negra	(1) 8,20
201907	10	Rejilla Filtro RF-90 negra	8,32
201908	10	Rejilla Filtro RF-120 negra	8,55
201909	10	Rejilla Filtro RF-175 negra	11,09
201918	1	Rejilla Filtro RFP-109x109 persiana gris	(2) 15,47
201919	1	Rejilla Filtro RFP-116x116 persiana gris	16,61
201910	1	Rejilla Filtro RFP-148x148 persiana gris	18,48
201944	1	Rejilla Filtro RFP-204x204 persiana gris	19,25
201945	1	Rejilla Filtro RFP-255x255 persiana gris	25,92
201946	1	Rejilla Filtro RFP-320x320 persiana gris	37,62
201920	1	Rejilla Filtro RFPS-130x130 persiana superficie	(3) 15,60
201947	1	Rejilla Filtro RFP-204x204 campana gris	(2) 24,87
201948	1	Rejilla Filtro RFP-255x255 campana gris	41,38
201949	1	Rejilla Filtro RFP-320x320 campana gris	50,16
201911	50	Rejilla metálica RJM-80	(4) 4,16
201912	25	Rejilla metálica RJM-90	4,85
201913	40	Rejilla metálica RJM-120	5,54
201914	20	Rejilla metálica RJM-175	7,62
201916	1	Cable conexión 1m	4,58

TERMOSTATOS - HIGROSTATO

CÓDIGO	ENVASE EMBALAJE	DESCRIPCIÓN	€/ud
201921	10	Termostato Regulable 0-60° Azul	(4) 23,63
201922	10	Termostato Regulable 0-60° Rojo	(5) 23,63
201923	10	Higrostat 35%-95%	(6) 98,00

4 **Azul = Contacto abierto = Cierra el circuito con la subida de temperatura por encima del umbral fijado, poniendo en funcionamiento el aparato al cual se conecta el termostato, normalmente un sistema de refrigeración o ventilación.**

5 **Rojo = Contacto cerrado = Abre el circuito con la subida de temperatura por encima del umbral fijado, apagando el aparato al cual se conecta el termostato, normalmente un sistema de calefacción.**

RESISTENCIAS CALEFACTORAS

CÓDIGO	ENVASE EMBALAJE	DESCRIPCIÓN	€/ud
201924	1	Resistencia cal. 65x70 carril 45W 230V	47,12
201925	1	Resistencia cal. 140x70 carril 60W 230V	47,91
201927	1	Resistencia cal. 140x70 carril 100W 230V	85,18

EXTRACTORES

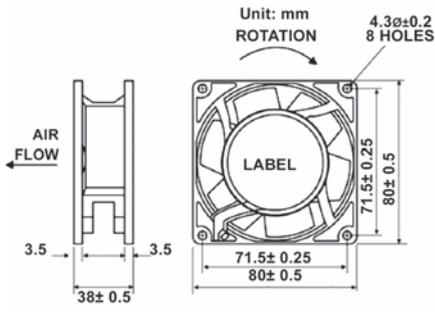

201901 - 201938 - 201950

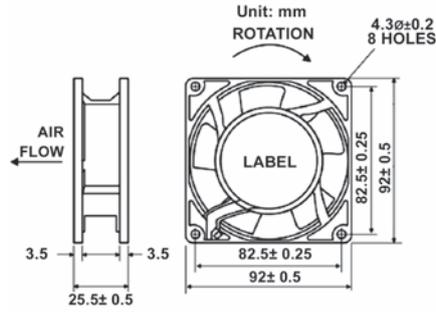

201902 - 201936 - 201937

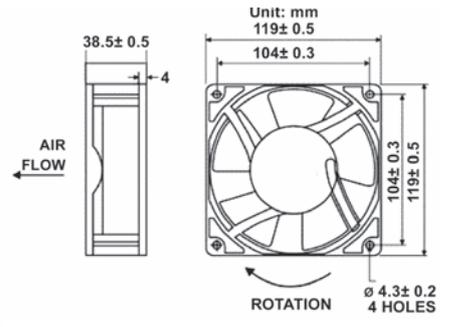

201903 - 201935
201943 - 201952

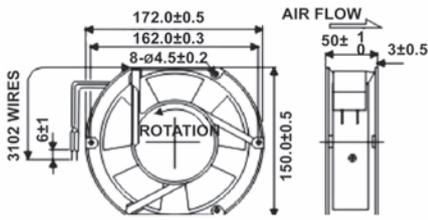

201904

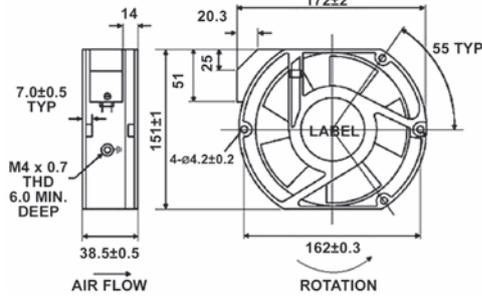

201905

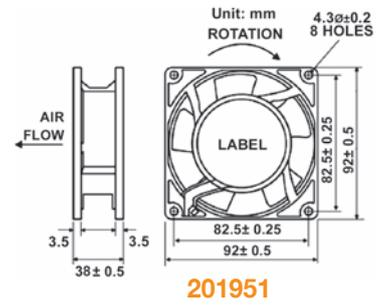

201951

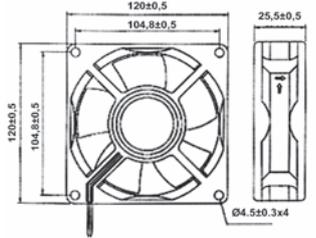

201933 - 201934

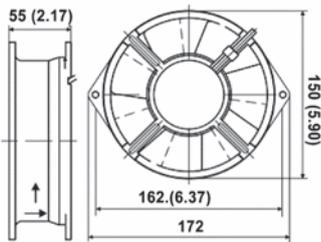

201953

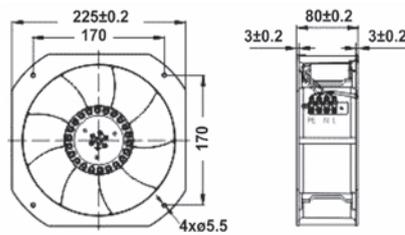

201954

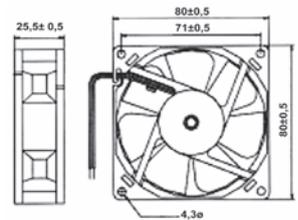

201931 - 201932

201960	
Extractor	92 x 38 mm.
Rejilla	120 x 120 mm.

201961	
Extractor	120 x 38 mm.
Rejilla	152 x 152 mm.

201962	
Extractor	170 x 51 mm.
Rejilla	204 x 204 mm.

201963	
Extractor	170 x 51 mm.
Rejilla	255 x 255 mm. <i>Con adaptador campana</i>

201964	
Extractor	225 x 220 mm
Rejilla	323 x 323 mm. <i>Con adaptador campana</i>



PLETINAS DE COBRE LISAS

CÓDIGO	ENVASE EMBALAJE	DESCRIPCIÓN	€/metro
221101		Mts. pletina de cobre lisa 10x2	<i>consultar</i>
221102		Mts. pletina de cobre lisa 10x3	<i>consultar</i>
221103		Mts. pletina de cobre lisa 10x4	<i>consultar</i>
221104		Mts. pletina de cobre lisa 10x5	<i>consultar</i>
221105		Mts. pletina de cobre lisa 12x2	<i>consultar</i>
221106		Mts. pletina de cobre lisa 12x3	<i>consultar</i>
221107		Mts. pletina de cobre lisa 12x4	<i>consultar</i>
221108		Mts. pletina de cobre lisa 12x5	<i>consultar</i>
221109		Mts. pletina de cobre lisa 15x2	<i>consultar</i>
221110		Mts. pletina de cobre lisa 15x3	<i>consultar</i>
221111		Mts. pletina de cobre lisa 15x4	<i>consultar</i>
221112		Mts. pletina de cobre lisa 15x5	<i>consultar</i>
221113		Mts. pletina de cobre lisa 20x2	<i>consultar</i>
221114		Mts. pletina de cobre lisa 20x3	<i>consultar</i>
221115		Mts. pletina de cobre lisa 20x4	<i>consultar</i>
221116		Mts. pletina de cobre lisa 20x5	<i>consultar</i>
221117		Mts. pletina de cobre lisa 20x10	<i>consultar</i>
221118		Mts. pletina de cobre lisa 25x2	<i>consultar</i>
221119		Mts. pletina de cobre lisa 25x3	<i>consultar</i>
221120		Mts. pletina de cobre lisa 25x4	<i>consultar</i>
221121		Mts. pletina de cobre lisa 25x5	<i>consultar</i>
221122		Mts. pletina de cobre lisa 25x10	<i>consultar</i>
221123		Mts. pletina de cobre lisa 30x5	<i>consultar</i>
221124		Mts. pletina de cobre lisa 30x10	<i>consultar</i>
221125		Mts. pletina de cobre lisa 35x5	<i>consultar</i>
221126		Mts. pletina de cobre lisa 35x10	<i>consultar</i>
221127		Mts. pletina de cobre lisa 40x5	<i>consultar</i>
221128		Mts. pletina de cobre lisa 40x10	<i>consultar</i>
221129		Mts. pletina de cobre lisa 45x5	<i>consultar</i>
221130		Mts. pletina de cobre lisa 45x10	<i>consultar</i>
221131		Mts. pletina de cobre lisa 50x5	<i>consultar</i>
221132		Mts. pletina de cobre lisa 50x10	<i>consultar</i>
221133		Mts. pletina de cobre lisa 60x5	<i>consultar</i>
221134		Mts. pletina de cobre lisa 60x10	<i>consultar</i>
221135		Mts. pletina de cobre lisa 70x5	<i>consultar</i>
221136		Mts. pletina de cobre lisa 70x10	<i>consultar</i>
221137		Mts. pletina de cobre lisa 80x5	<i>consultar</i>
221138		Mts. pletina de cobre lisa 80x10	<i>consultar</i>
221139		Mts. pletina de cobre lisa 100x5	<i>consultar</i>
221140		Mts. pletina de cobre lisa 100x10	<i>consultar</i>
221141		Mts. pletina de cobre lisa 120x10	<i>consultar</i>
221142		Mts. pletina de cobre lisa 125x10	<i>consultar</i>
221143		Mts. pletina de cobre lisa 150x10	<i>consultar</i>
221144		Mts. pletina de cobre lisa 200x10	<i>consultar</i>
221145		Mts. pletina de cobre lisa 250x10	<i>consultar</i>

**Unidad de venta mínima: 2000 mm.
Cortes según necesidades del cliente**



**Fabricación de piezas especiales,
mecanizado y acabados
según planos y necesidades
del cliente**

PLETINAS DE COBRE PARA APLICACIONES ELÉCTRICAS SEGÚN EN 13601



Intensidad admisible DIN 43671:

- Temperatura ambiente 35°C
- Temperatura final barras 65°C
- Conductividad 56 M/Ω mm²

En el caso de varias barras en paralelo, la distancia entre las barras se toma igual al espesor.

Para corriente alterna la distancia neta entre las fases se toma >0,8 la distancia entre ejes de fases.

Ancho x Espesor	Acabado Brillante			
	Número de barras			
	1	2	3	4
12x2	108	182	216	
15x2	128	212	247	
15x3	162	282	361	
20x2	162	264	298	
20x3	204	348	431	
20x5	274	500	690	
20x10	427	825	1180	
25x3	245	412	498	
25x5	327	586	795	
30x3	285	476	564	
30x5	379	672	896	
30x10	573	1060	1480	
40x3	366	600	690	
40x5	482	836	1090	
40x10	715	1290	1770	2280
50x5	583	994	1260	1920
50x10	852	1510	2040	2600
60x5	688	1150	1440	2210
60x10	985	1720	2300	2900
80x5	885	1450	1750	2720
80x10	1240	2110	2790	3450
100x5	1080	1730	2050	3190
100x10	1490	2480	3260	3980
120x10	1740	2860	3740	4500
160x10	2220	3590	4680	5530
200x10	2690	4310	5610	6540

Anchura nominal		Tolerancia anchura	Tolerancia de espesor nominal para la gama de espesores					
mayor que	hasta incluido		de 0,5 hasta 3 incluido	mayor que 3 hasta 6 incluido	mayor que 6 hasta 10 incluido	mayor que 10 hasta 18 incluido	mayor que 18 hasta 30 incluido	mayor que 30 hasta 40 incluido
1b	10	± 0,08	± 0,05	± 0,06	± 0,08	-	-	-
10	18	± 0,10	± 0,05	± 0,06	± 0,08	± 0,10	-	-
18	30	± 0,15	± 0,05	± 0,07	± 0,09	± 0,10	± 0,15	-
30	50	± 0,20	± 0,06	± 0,09	± 0,10	± 0,12	± 0,15	± 0,20
50	80	± 0,25	± 0,09	± 0,10	± 0,12	± 0,15	± 0,18	± 0,25
80	120	± 0,30	-	± 0,12	± 0,15	± 0,18	± 0,23	± 0,30
120	160	± 0,40	-	-	± 0,18	± 0,20	± 0,20	± 0,35
160	200	± 0,50	-	-	± 0,20	± 0,25	± 0,30	± 0,40

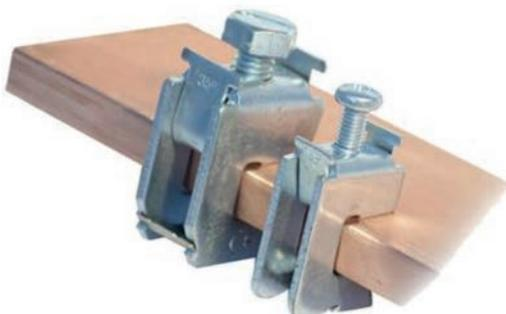



Bajo demanda y sobre plano otras medidas y mecanizaciones

PLETINAS COBRE TALADRADAS ROSCADAS

CÓDIGO	ENVASE EMBALAJE	DESCRIPCIÓN	€/ud
220511	10	Pletina roscada PLE-R 12x2x1000 M5	consultar
220512	10	Pletina roscada PLE-R 12x4x1000 M5	consultar
220513	4	Pletina roscada PLE-R 18x4x1000 M8	consultar
220514	4	Pletina roscada PLE-R 25x4x1000 M6	consultar
220521	4	Pletina roscada PLE-R 12x5x1000 M5	consultar
220522	4	Pletina roscada PLE-R 15x5x1000 M6	consultar
220523	4	Pletina roscada PLE-R 20x5x1000 M6	consultar
220524	4	Pletina roscada PLE-R 32x5x1000 M6	consultar
220531	4	Pletina roscada PLE-R 20x10x1000 M8	consultar
220532	4	Pletina roscada PLE-R 30x10x1000 M8	consultar

Longitud 1000 mm.
Longitud 2000 mm. consultar existencias

PLETINAS COBRE PERFORADAS

CÓDIGO	ENVASE EMBALAJE	DESCRIPCIÓN	€/ud
220541	2	Pletina una perforacion PLE-1FT 25x5	consultar
220542	2	Pletina doble perforacion PLE-2FT 50x5	consultar
220543	2	Pletina doble perforacion PLE-2FT 63x5	consultar
220544	2	Pletina doble perforacion PLE-2FT 80x5	consultar
220545	2	Pletina doble perforacion PLE-2FT 100x5	consultar
220546	2	Pletina doble perforacion PLE-2FT 125x5	consultar
220551	2	Pletina doble perforacion PLE-2FT 50x10	consultar
220552	2	Pletina doble perforacion PLE-2FT 60x10	consultar
220553	2	Pletina doble perforacion PLE-2FT 80x10	consultar
220554	2	Pletina doble perforacion PLE-2FT 100x10	consultar
220555	2	Pletina doble perforacion PLE-2FT 120x10	consultar

Longitud 1750 mm.

PLETINAS COBRE CONEXIÓN CON TORNILLOS

CÓDIGO	ENVASE EMBALAJE	DESCRIPCIÓN	€/ud
220565	10	Pletina conexión 133-10x3x2000 (1)	48,58
220566	10	Pletina conexión 133-15x5x2000	87,85
220567	10	Kit 133 10 clips 20 tornillos (2)	1,40

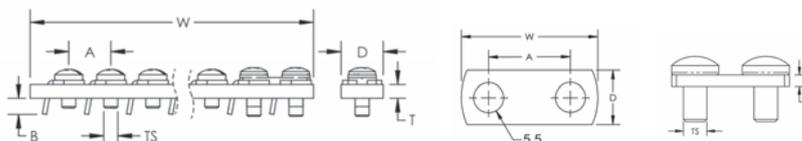
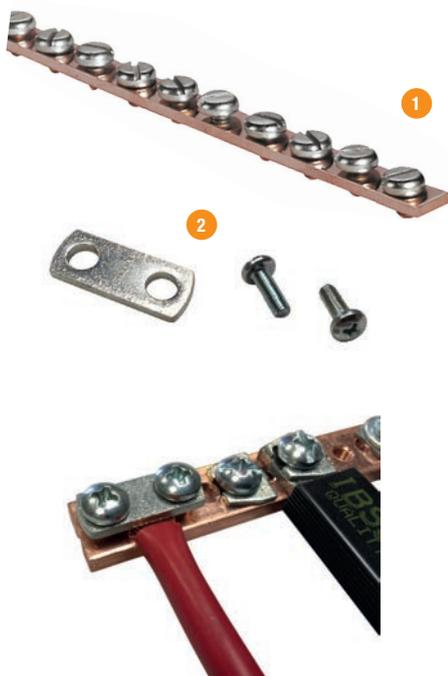

CÓDIGO	DIMENSIONES (mm)				
	W	D	A	B	T
220565	2000	10	15	4,8	3
220566	2000	15	15	6,8	5
220567	25	10	15	-	2,5

CONECTORES Y PETACAS PARA PLETINAS

CÓDIGO	ENVASE EMBALAJE	DESCRIPCIÓN	€/ud
220571	100	Conector para pletinas roscadas 12x2 M5	(1) 0,90
220572	3	Petaca conexión PET-50x24	(2) 13,10
220573	3	Petaca conexión PET-50x32	13,20
220574	3	Petaca conexión PET-50x40	13,31
220575	3	Petaca conexión PET-80x24	13,44
220576	3	Petaca conexión PET-80x32	13,55
220577	3	Petaca conexión PET-80x50	13,94
220578	3	Petaca conexión PET-100x32	14,97
220579	3	Petaca conexión PET-120x32	22,86
220581	3	Petaca conexión PET-BC 30	(3) 26,97
220582	3	Petaca conexión PET-BC 40	31,71
220583	3	Petaca conexión PET-BC 50	39,69
220584	3	Petaca conexión PET-BC 63	49,14
220585	3	Petaca conexión PET-BC 80	69,39
220586	3	Petaca conexión PET-BC 100	92,19



CÓDIGO	DIMENSIONES (mm)						Apriete
	A	B	C	D	E	F	
220572	50	20-24	60	36	75	52	10
220573	50	32	60	44	75	60	10
220574	50	40	60	52	75	68	10
220575	80	20-24	90	36	105	52	10
220576	80	32	90	44	105	60	10
220577	80	50	90	62	105	78	10
220578	100	32	110	44	125	60	10
220579	120	32	130	44	145	60	10
220581	56	42	30				7
220582	66	52	40				7
220583	83	64	50				20
220584	93	74	63				20
220585	118	96	80				40
220586	144	118	100				40

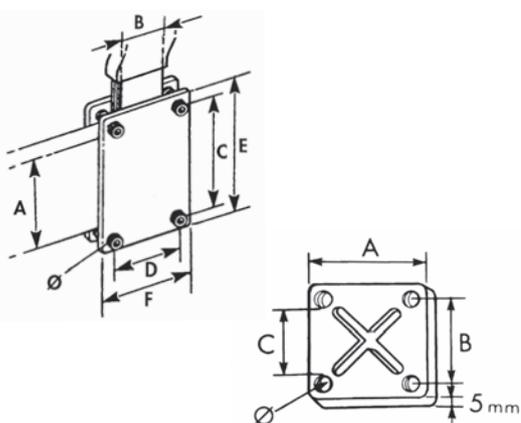

BRIDAS DE CONEXIÓN Y DERIVACIÓN

CÓDIGO	ENVASE EMBALAJE	DESCRIPCIÓN	€/ud
210201	100	Brida tornillo BT-15	(1) 1,28
210202	50	Brida tornillo BT-25	(2) 1,67
210209	25	Brida tornillo B2T-15/20	(3) 2,45
210211	40	Brida tornillo "C" BTC - 5/16	(4) 2,56
210212	40	Brida tornillo "C" BTC - 10/16	(5) 3,35
210213	20	Brida tornillo "C" BTC - 10/35	(5) 4,66
210214	20	Brida tornillo "C" BTC - 10/50	(5) 6,55
210215	10	Brida tornillo "C" BTC - 10/70	(5) 8,74
210216	10	Brida tornillo "C" BTC - 10/120	(5) 13,33
210217	10	Brida tornillo "C" BTC - 10/185	(5) 19,48



	1	2	3	4	5
Ancho Pletina mm.	15	20	15-20	15-20/5	15-20/10
Secc. Máxima	16	25	50	16	16-185

PLETINAS FLEXIBLES

CÓDIGO	ENVASE EMBALAJE	DESCRIPCIÓN	€/ud
220603	10	Pletina Flexible PFLEX-125A 6x9x0,8	<i>consultar</i>
220605	10	Pletina Flexible PFLEX-125A 2x16x0,8	<i>consultar</i>
220608	10	Pletina Flexible PFLEX-250A 4x16x0,8	<i>consultar</i>
220609	5	Pletina Flexible PFLEX-250A 2x20x1	<i>consultar</i>
220610	5	Pletina Flexible PFLEX-250A 3x20x1	<i>consultar</i>
220611	5	Pletina Flexible PFLEX-250A 2x24x1	<i>consultar</i>
220612	10	Pletina Flexible PFLEX-400A 6x16x0,8	<i>consultar</i>
220613	10	Pletina Flexible PFLEX-400A 10x16x0,8	<i>consultar</i>
220614	5	Pletina Flexible PFLEX-400A 4X20X1	<i>consultar</i>
220615	5	Pletina Flexible PFLEX-400A 5X20X1	<i>consultar</i>
220616	5	Pletina Flexible PFLEX-400A 6X20X1	<i>consultar</i>
220617	5	Pletina Flexible PFLEX-400A 3X24X1	<i>consultar</i>
220618	5	Pletina Flexible PFLEX-400A 4X24X1	<i>consultar</i>
220619	5	Pletina Flexible PFLEX-400A 2X32X1	<i>consultar</i>
220620	5	Pletina Flexible PFLEX-400A 3X32X1	<i>consultar</i>
220621	5	Pletina Flexible PFLEX-400A 2X40X1	<i>consultar</i>
220622	5	Pletina Flexible PFLEX-500A 5X24X1	<i>consultar</i>
220623	5	Pletina Flexible PFLEX-500A 6X24X1	<i>consultar</i>
220624	5	Pletina Flexible PFLEX-500A 4X32X1	<i>consultar</i>
220625	5	Pletina Flexible PFLEX-500A 3X40X1	<i>consultar</i>
220626	5	Pletina Flexible PFLEX-500A 4X40X1	<i>consultar</i>
220627	5	Pletina Flexible PFLEX-500A 3X50X1	<i>consultar</i>
220628	5	Pletina Flexible PFLEX-630A 10X20X1	<i>consultar</i>
220629	5	Pletina Flexible PFLEX-630A 8X24X1	<i>consultar</i>
220630	5	Pletina Flexible PFLEX-630A 5X32X1	<i>consultar</i>
220631	5	Pletina Flexible PFLEX-630A 6X32X1	<i>consultar</i>
220632	5	Pletina Flexible PFLEX-630A 5X40X1	<i>consultar</i>
220633	5	Pletina Flexible PFLEX-630A 4X50X1	<i>consultar</i>
220634	5	Pletina Flexible PFLEX-800A 10X24X1	<i>consultar</i>
220635	5	Pletina Flexible PFLEX-800A 8X32X1	<i>consultar</i>
220636	5	Pletina Flexible PFLEX-800A 6X40X1	<i>consultar</i>
220637	5	Pletina Flexible PFLEX-800A 5X50X1	<i>consultar</i>
220638	2	Pletina Flexible PFLEX-800A 4X63X1	<i>consultar</i>
220639	5	Pletina Flexible PFLEX-800A 3X80X1	<i>consultar</i>
220640	5	Pletina Flexible PFLEX-1000A 10X32X1	<i>consultar</i>
220641	5	Pletina Flexible PFLEX-1000A 8X40X1	<i>consultar</i>
220642	5	Pletina Flexible PFLEX-1000A 10X40X1	<i>consultar</i>
220643	2	Pletina Flexible PFLEX-1000A 6X50X1	<i>consultar</i>
220644	2	Pletina Flexible PFLEX-1000A 8X50X1	<i>consultar</i>
220645	2	Pletina Flexible PFLEX-1000A 5X63X1	<i>consultar</i>
220646	2	Pletina Flexible PFLEX-1000A 6X63X1	<i>consultar</i>
220647	2	Pletina Flexible PFLEX-1000A 4X80X1	<i>consultar</i>
220648	2	Pletina Flexible PFLEX-1000A 5X80X1	<i>consultar</i>
220649	2	Pletina Flexible PFLEX-1250A 10X50X1	<i>consultar</i>
220650	2	Pletina Flexible PFLEX-1250A 8X63X1	<i>consultar</i>
220651	2	Pletina Flexible PFLEX-1250A 6X80X1	<i>consultar</i>
220652	2	Pletina Flexible PFLEX-1250A 5X100X1	<i>consultar</i>
220653	2	Pletina Flexible PFLEX-1250A 6X100X1	<i>consultar</i>
220654	2	Pletina Flexible PFLEX-1600A 10X63X1	<i>consultar</i>
220655	2	Pletina Flexible PFLEX-1600A 8X80X1	<i>consultar</i>
220656	2	Pletina Flexible PFLEX-1600A 10X80X1	<i>consultar</i>
220657	2	Pletina Flexible PFLEX-1600A 8X100X1	<i>consultar</i>
220658	2	Pletina Flexible PFLEX-1600A 10X100X1	<i>consultar</i>
220659	2	Pletina Flexible PFLEX-1600A 12X100X1	<i>consultar</i>
220660	1	Pletina Flexible PFLEX-1600A 10X120X1	<i>consultar</i>

Longitud 2000 mm.

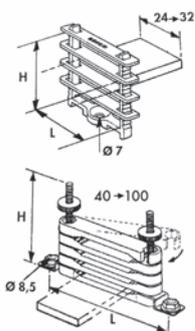

SEPARADORES PARA PLETINAS FLEXIBLES

CÓDIGO	ENVASE EMBALAJE	DESCRIPCIÓN	H	L	€/ud
220661	25	Separador FS-24	53	30	5,47
220662	25	Separador FS-32	53	38	6,95
220663	10	Separador FS-40/63	95	150	22,30
220664	10	Separador FS-80/100	140	200	48,15

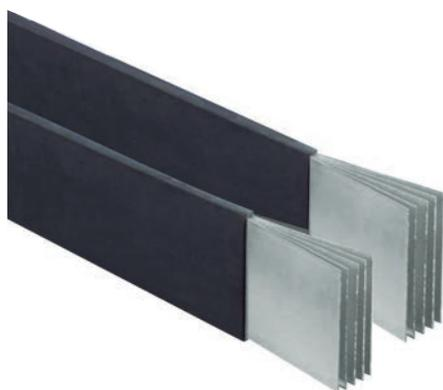

Cobre estañado
Mayor flexibilidad

PLETINAS FLEXIBLES LIBRES DE HALÓGENOS

CÓDIGO	ENVASE EMBALAJE	DESCRIPCIÓN	€/ud
221200	4	Pletina Flex. LdH PFLH-125A 8x6x0,5	consultar
221201	4	Pletina Flex. LdH PFLH-125A 3x9x0,8	consultar
221202	4	Pletina Flex. LdH PFLH-125A 6x9x0,8	consultar
221203	4	Pletina Flex. LdH PFLH-125A 9x9x0,8	consultar
221204	4	Pletina Flex. LdH PFLH-125A 3x13x0,5	consultar
221205	4	Pletina Flex. LdH PFLH-250A 6x13x0,5	consultar
221206	4	Pletina Flex. LdH PFLH-250A 2x15,5x0,8	consultar
221207	4	Pletina Flex. LdH PFLH-250A 4x15,5x0,8	consultar
221208	4	Pletina Flex. LdH PFLH-250A 6x15,5x0,8	consultar
221209	4	Pletina Flex. LdH PFLH-250A 10x15,5x0,8	consultar
221210	3	Pletina Flex. LdH PFLH-250A 2x20x1	consultar
221211	3	Pletina Flex. LdH PFLH-400A 3x20x1	consultar
221212	3	Pletina Flex. LdH PFLH-400A 4x20x1	consultar
221213	3	Pletina Flex. LdH PFLH-400A 5x20x1	consultar
221214	3	Pletina Flex. LdH PFLH-400A 6x20x1	consultar
221215	3	Pletina Flex. LdH PFLH-400A 10x20x1	consultar
221216	3	Pletina Flex. LdH PFLH-400A 2x24x1	consultar
221217	3	Pletina Flex. LdH PFLH-400A 3x24x1	consultar
221218	3	Pletina Flex. LdH PFLH-400A 4x24x1	consultar
221219	3	Pletina Flex. LdH PFLH-400A 5x24x1	consultar
221220	3	Pletina Flex. LdH PFLH-400A 6x24x1	consultar
221221	3	Pletina Flex. LdH PFLH-500A 8x24x1	consultar
221222	3	Pletina Flex. LdH PFLH-500A 10x24x1	consultar
221223	2	Pletina Flex. LdH PFLH-500A 2x32x1	consultar
221224	2	Pletina Flex. LdH PFLH-500A 3x32x1	consultar
221225	2	Pletina Flex. LdH PFLH-500A 4x32x1	consultar
221226	2	Pletina Flex. LdH PFLH-500A 5x32x1	consultar
221227	2	Pletina Flex. LdH PFLH-630A 6x32x1	consultar
221228	2	Pletina Flex. LdH PFLH-630A 8x32x1	consultar
221229	2	Pletina Flex. LdH PFLH-630A 10x32x1	consultar
221230	2	Pletina Flex. LdH PFLH-630A 2x40x1	consultar
221231	2	Pletina Flex. LdH PFLH-630A 3x40x1	consultar
221232	2	Pletina Flex. LdH PFLH-630A 4x40x1	consultar
221233	2	Pletina Flex. LdH PFLH-800A 5x40x1	consultar
221234	2	Pletina Flex. LdH PFLH-800A 6x40x1	consultar
221235	2	Pletina Flex. LdH PFLH-800A 8x40x1	consultar
221236	2	Pletina Flex. LdH PFLH-800A 10x40x1	consultar
221237	1	Pletina Flex. LdH PFLH-800A 3x50x1	consultar
221238	1	Pletina Flex. LdH PFLH-1000A 4x50x1	consultar
221239	1	Pletina Flex. LdH PFLH-1000A 5x50x1	consultar
221240	1	Pletina Flex. LdH PFLH-1000A 6x50x1	consultar
221241	1	Pletina Flex. LdH PFLH-1000A 8x50x1	consultar
221242	1	Pletina Flex. LdH PFLH-1000A 10x50x1	consultar
221244	1	Pletina Flex. LdH PFLH-1000A 4x63x1	consultar
221245	1	Pletina Flex. LdH PFLH-1000A 5x63x1	consultar
221246	1	Pletina Flex. LdH PFLH-1000A 6x63x1	consultar
221247	1	Pletina Flex. LdH PFLH-1000A 8x63x1	consultar
221248	1	Pletina Flex. LdH PFLH-1250A 10x63x1	consultar
221249	1	Pletina Flex. LdH PFLH-1250A 4x80x1	consultar
221250	1	Pletina Flex. LdH PFLH-1250A 5x80x1	consultar
221251	1	Pletina Flex. LdH PFLH-1250A 6x80x1	consultar
221252	1	Pletina Flex. LdH PFLH-1250A 8x80x1	consultar
221253	1	Pletina Flex. LdH PFLH-1600A 10x80x1	consultar
221254	1	Pletina Flex. LdH PFLH-1600A 5x100x1	consultar
221255	1	Pletina Flex. LdH PFLH-1600A 6x100x1	consultar
221256	1	Pletina Flex. LdH PFLH-1600A 8x100x1	consultar
221257	1	Pletina Flex. LdH PFLH-1600A 10x100x1	consultar
221258	1	Pletina Flex. LdH PFLH-1600A 12x100x1	consultar
221259	1	Pletina Flex. LdH PFLH-1600A 10x120x1	consultar

Longitud 2000 mm.

TRENZAS AISLADAS FLEXIBLES

CÓDIGO	ENVASE EMBALAJE	DESCRIPCIÓN	€/ud
220700	10	Trenza aislada flex. TAFLEX 25-230-6	160A. <i>consultar</i>
220701	10	Trenza aislada flex. TAFLEX-25-330-6	<i>consultar</i>
220702	10	Trenza aislada flex. TAFLEX-25-430-6	<i>consultar</i>
220703	10	Trenza aislada flex. TAFLEX-25-530-6	<i>consultar</i>
220704	10	Trenza aislada flex. TAFLEX-25-630-6	<i>consultar</i>
220705	10	Trenza aislada flex. TAFLEX-25-830-6	<i>consultar</i>
220706	10	Trenza aislada flex. TAFLEX-25-1030-6	<i>consultar</i>
220707	10	Trenza aislada flex. TAFLEX-50-230-8-10	250A. <i>consultar</i>
220708	10	Trenza aislada flex. TAFLEX-50-330-8-10	<i>consultar</i>
220709	10	Trenza aislada flex. TAFLEX-50-430-8-10	<i>consultar</i>
220710	10	Trenza aislada flex. TAFLEX-50-530-8-10	<i>consultar</i>
220711	10	Trenza aislada flex. TAFLEX-50-630-8-10	<i>consultar</i>
220712	10	Trenza aislada flex. TAFLEX-50-830-8-10	<i>consultar</i>
220713	10	Trenza aislada flex. TAFLEX-50-1030-8-10	<i>consultar</i>
220714	10	Trenza aislada flex. TAFLEX-70-230-8-10	300A. <i>consultar</i>
220715	10	Trenza aislada flex. TAFLEX-70-330-8-10	<i>consultar</i>
220716	10	Trenza aislada flex. TAFLEX-70-430-8-10	<i>consultar</i>
220717	10	Trenza aislada flex. TAFLEX-70-530-8-10	<i>consultar</i>
220718	10	Trenza aislada flex. TAFLEX-70-630-8-10	<i>consultar</i>
220719	10	Trenza aislada flex. TAFLEX-70-830-8-10	<i>consultar</i>
220720	10	Trenza aislada flex. TAFLEX-70-1030-8-10	<i>consultar</i>
220721	10	Trenza aislada flex. TAFLEX-100-230-8-10	350A. <i>consultar</i>
220722	10	Trenza aislada flex. TAFLEX-100-330-8-10	<i>consultar</i>
220723	10	Trenza aislada flex. TAFLEX-100-430-8-10	<i>consultar</i>
220724	10	Trenza aislada flex. TAFLEX-100-530-8-10	<i>consultar</i>
220725	10	Trenza aislada flex. TAFLEX-100-630-8-10	<i>consultar</i>
220726	10	Trenza aislada flex. TAFLEX-100-830-8-10	<i>consultar</i>
220727	10	Trenza aislada flex. TAFLEX-100-1030-8-10	<i>consultar</i>
220728	2	Trenza aislada flex. TAFLEX-120-230-10	400A. <i>consultar</i>
220729	2	Trenza aislada flex. TAFLEX-120-330-10	<i>consultar</i>
220730	2	Trenza aislada flex. TAFLEX-120-430-10	<i>consultar</i>
220731	2	Trenza aislada flex. TAFLEX-120-530-10	<i>consultar</i>
220732	2	Trenza aislada flex. TAFLEX-120-630-10	<i>consultar</i>
220733	2	Trenza aislada flex. TAFLEX-120-830-10	<i>consultar</i>
220734	2	Trenza aislada flex. TAFLEX-120-1030-10	<i>consultar</i>
220735	2	Trenza aislada flex. TAFLEX-185-330-10-12	500A. <i>consultar</i>
220736	2	Trenza aislada flex. TAFLEX-185-430-10-12	<i>consultar</i>
220737	2	Trenza aislada flex. TAFLEX-185-530-10-12	<i>consultar</i>
220738	2	Trenza aislada flex. TAFLEX-185-630-10-12	<i>consultar</i>
220739	2	Trenza aislada flex. TAFLEX-185-830-10-12	<i>consultar</i>
220740	2	Trenza aislada flex. TAFLEX-185-1030-10-12	<i>consultar</i>
220741	2	Trenza aislada flex. TAFLEX-240-330-10-12	630A. <i>consultar</i>
220742	2	Trenza aislada flex. TAFLEX-240-430-10-12	<i>consultar</i>
220743	2	Trenza aislada flex. TAFLEX-240-530-10-12	<i>consultar</i>
220744	2	Trenza aislada flex. TAFLEX-240-630-10-12	<i>consultar</i>
220745	2	Trenza aislada flex. TAFLEX-240-830-10-12	<i>consultar</i>
220746	2	Trenza aislada flex. TAFLEX-240-1030-10-12	<i>consultar</i>

- **Excelente contacto eléctrico con las palas macizas prensosoldadas.**
- **Buena resistencia a la tracción.**
- **Alta resistencia: compuesto vinílico.**
- **Muy buena resistencia a las vibraciones.**

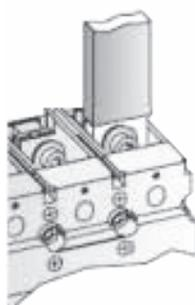

Conexión directa

No se necesita terminales ni pantallas

Los conductores de trenza aislada se adaptan a todos los interruptores de caja moldeada a nivel mundial



CONEXIONES DE COBRE ESTAÑADAS

CÓDIGO	ENVASE EMBALAJE	DESCRIPCIÓN Sección mm ² x Longitud	INTENSIDAD MAX (A)	€/ud
240421	10	Conexión 10x200 M6 estañada	85	31,72
240422	10	Conexión 10x250 M6 estañada	85	32,98
240423	10	Conexión 16x200 M8 estañada	120	32,58
240424	10	Conexión 16x250 M8 estañada	120	36,76
240425	10	Conexión 25x200 M8 estañada	150	41,37
240426	10	Conexión 25x250 M8 estañada	150	43,88
240427	10	Conexión 35x200 M10 estañada	180	43,03
240428	10	Conexión 35x250 M10 estañada	180	45,41
240429	10	Conexión 50x200 M10 estañada	280	52,13
240430	10	Conexión 50x250 M10 estañada	280	56,66

Otras medidas consultar



Fabricación de conexiones especiales según planos y necesidades del cliente

TRENZA DE COBRE

CÓDIGO	ENVASE EMBALAJE	DESCRIPCIÓN	INTENSIDAD MAX (A)	€/metro
240401	25	Mts. trenza de cobre 10mm.	85	14,62
240402	25	Mts. trenza de cobre 16mm.	120	21,08
240403	25	Mts. trenza de cobre 25mm.	150	34,49
240404	25	Mts. trenza de cobre 35mm.	180	45,86
240405	25	Mts. trenza de cobre 50mm.	280	59,21



TRENZA DE COBRE ESTAÑADA

CÓDIGO	ENVASE EMBALAJE	DESCRIPCIÓN	INTENSIDAD MAX (A)	€/metro
240411	25	Mts. trenza de cobre 10mm. estañada	85	18,26
240412	25	Mts. trenza de cobre 16mm. estañada	120	26,37
240413	25	Mts. trenza de cobre 25mm. estañada	150	43,13
240414	25	Mts. trenza de cobre 35mm. estañada	180	57,34
240415	25	Mts. trenza de cobre 50mm. estañada	280	74,01



Disponemos de otras secciones así como de trenza Cu estañada redonda, y aisladas

Consultar

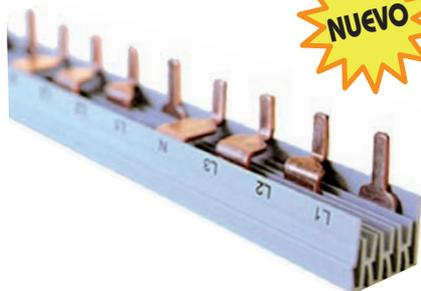
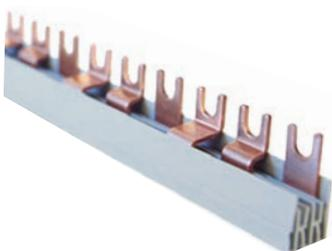
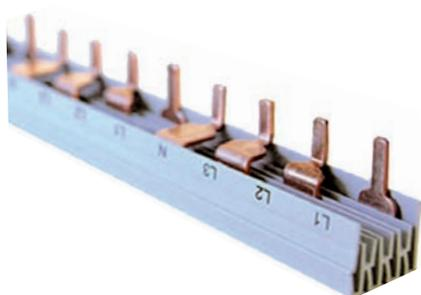
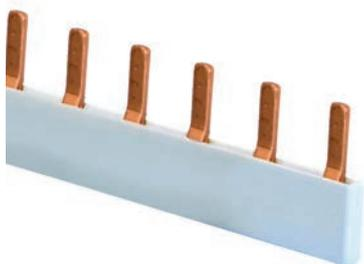

PUNTES CONECTORES PIA 10 mm.

CÓDIGO	ENVASE EMBALAJE	DESCRIPCIÓN	LONGITUD	€/ud
220101	20	Puente PIA PC 1x12	210	8,25
220102	10	Puente PIA PC 2x5	212	12,47
220103	10	Puente pPIA PC 2x6	212	12,98
220104	10	Puente PIA PC 3x4	212	16,82
220105	10	Puente PIA PC 4x3	212	24,35

PUNTES CONECTORES PIA 10 mm.

CÓDIGO	ENVASE EMBALAJE	DESCRIPCIÓN	LONGITUD	€/ud
220106	10	Puente PIA PC 1x57	1000	34,08
220107	10	Puente PIA PC 1x57 fase (17,5)	1000	31,00
220108	10	Puente PIA PC 1x57 neutro (17,5)	1000	31,00
220109	10	Puente PIA PC 2x28	1000	38,05
220110	10	Puente PIA PC 3x19	1000	55,06
220111	10	Puente PIA PC 4x14	1000	97,60
220112	10	Puente PIA PC 27 RN+SN+TN	1000	102,04
220113	10	Puente PIA PC 2x57 DPN	1000	57,60

Longitud 1000 mm.

PUNTES CONECTORES HORQUILLA PIA 10 mm.

CÓDIGO	ENVASE EMBALAJE	DESCRIPCIÓN	LONGITUD	€/ud
220114	10	Puente PIA PC 2x28 horquilla	1000	63,25
220115	10	Puente PIA PC 3x19 horquilla	1000	84,54
220116	10	Puente PIA PC 4x14 horquilla	1000	97,60

Longitud 1000 mm.

Intensidad máxima 63 A. Sección 10 mm².
Datos técnicos página 136

PUNTES CONECTORES PIA 16 mm.

CÓDIGO	ENVASE EMBALAJE	DESCRIPCIÓN	€/ud
220117	10	Puente PIA PCR 2x28-16	82,50
220118	10	Puente PIA PCR 3x19-16	99,98
220119	10	Puente PIA PCR 4x14-16	120,15

Intensidad máxima 80 A. Sección 16 mm².



TAPA FINAL PIA

CÓDIGO	ENVASE EMBALAJE	DESCRIPCIÓN	€/ud
220121	10	Tapa puente bipolar	0,77
220122	10	Tapa puente tripolar	0,95
220123	10	Tapa puente tetrapolar	1,11



BORNAS CONEXIÓN PIA

CÓDIGO	ENVASE EMBALAJE	DESCRIPCIÓN	€/ud
220131	25	Borna conexión punta 25	4,57
220132	25	Borna conexión punta 25 L	5,28
220133	25	Borna conexión punta 50	8,26

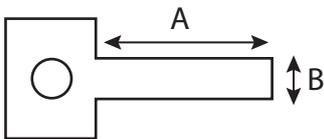

CÓDIGO	DIMENSIONES (mm)			
	A	B	Sección	Máx. A/V
220131	15	4	6 - 25	80 A / AC 690 V / DC 1500 V
220132	32	4	6 - 25	80 A / AC 690 V / DC 1500 V
220133	15	4	6 - 50	125 A / AC 690 V / DC 1500 V

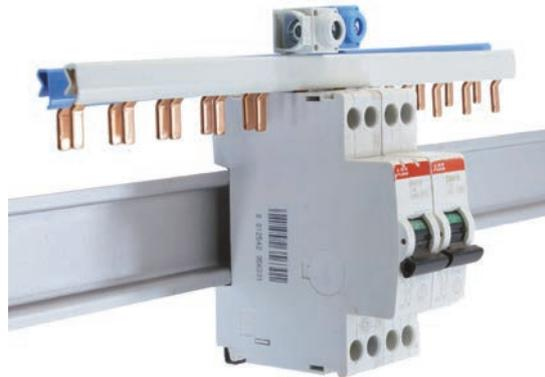
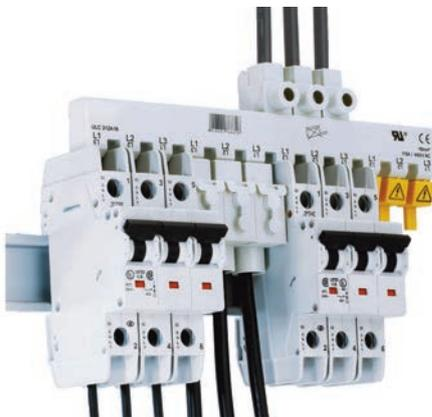

BRIDAS DE CONEXIÓN Y DERIVACIÓN



CÓDIGO	ENVASE EMBALAJE	DESCRIPCIÓN	€/ud
210201	100	Brida tornillo BT-15 (1)	1,28
210202	50	Brida tornillo BT-25 (2)	1,67
210209	25	Brida tornillo B2T-15/20 (3)	2,45
210211	40	Brida tornillo "C" BTC - 5/16 (4)	2,56
210212	40	Brida tornillo "C" BTC -10/16 (5)	3,35
210213	20	Brida tornillo "C" BTC -10/35 (5)	4,66
210214	20	Brida tornillo "C" BTC -10/50 (5)	6,55
210215	10	Brida tornillo "C" BTC -10/70 (5)	8,74
210216	10	Brida tornillo "C" BTC -10/120 (5)	13,33
210217	10	Brida tornillo "C" BTC -10/185 (5)	19,48

	1	2	3	4	5
Ancho Pletina mm.	15	20	15-20	15-20/5	15-20/10
Secc. Máxima	16	25	50	16	16-185

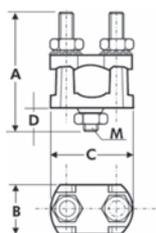

BORNAS BIMETÁLICAS DE ESPÁRAGO SENCILLAS

CÓDIGO	ENVASE EMBALAJE	DESCRIPCIÓN	€/ud
210401	25	Borna espárrago BE-50	6,10
210402	25	Borna espárrago BE-95	7,89
210403	15	Borna espárrago BE-150	9,77
210405	10	Borna espárrago BE-240	17,72

CÓDIGO	DIMENSIONES (mm)						I _N (A)
	A	B	C	D	E	M	
210401	41	18	25	13	-	6	125
210402	51,5	24	33	16,5	-	8	200
210403	59	24	41,5	18	-	10	280
210405	59	35	52	21	-	12	400

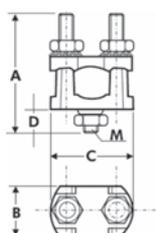

BORNAS BIMETÁLICAS DE ESPÁRAGO DOBLES

CÓDIGO	ENVASE EMBALAJE	DESCRIPCIÓN	€/ud
210406	25	Borna espárrago doble BE-50 D	7,37
210407	20	Borna espárrago doble BE-95 D	10,29
210408	10	Borna espárrago doble BE-150 D	14,76
210409	10	Borna espárrago doble BE-240 D	22,33

CÓDIGO	DIMENSIONES (mm)						I _N (A)
	A	B	C	D	E	M	
210406	46,5	18	25	13	-	6	125
210407	71,5	24	33	16,5	-	8	200
210408	83	26	41,5	18	-	10	280
210409	118,5	35	52	21	-	12	400



DERIBORNA ECO

CÓDIGO	ENVASE EMBALAJE	DESCRIPCIÓN	€/ud
210911	4/50	Deriborna DB-95-2 ECO	14,77
210912	4/50	Deriborna DB-95-D-2 ECO	20,86



DERIBORNAS 2 DERIVACIONES

CÓDIGO	ENVASE EMBALAJE	DESCRIPCIÓN	€/ud
210921	4	Deriborna 2 deriv. DB-95 - 2	16,18
210922	3	Deriborna 2 deriv. DB-150 - 2	28,82
210923	6	Deriborna 2 deriv. DB-240 - 2	80,02
210924	4	Deriborna 2 deriv. DB-95 D - 2	22,79
210925	3	Deriborna 2 deriv. DB-150 D - 2	32,25
210926	6	Deriborna 2 deriv. DB-240 D - 2	85,76



DERIBORNAS 4 DERIVACIONES

CÓDIGO	ENVASE EMBALAJE	DESCRIPCIÓN	€/ud
210931	4	Deriborna 4 deriv. DB-95 - 4	23,37
210932	3	Deriborna 4 deriv. DB-150 - 4	36,08
210933	6	Deriborna 4 deriv. DB-240 - 4	86,39
210934	4	Deriborna 4 deriv. DB-95 D - 4	26,69
210935	3	Deriborna 4 deriv. DB-150 D - 4	39,23
210936	6	Deriborna 4 deriv. DB-240 D - 4	97,53

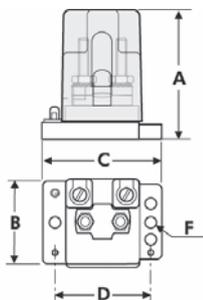

CÓDIGO	CABLE PRINCIPAL			CABLE DERIVADO			DIMENSIONES					AMP.
	Nº	min. (mm ²)	máx. (mm ²)	Nº	min. (mm ²)	máx. (mm ²)	A	B	C	D	F	I _n (A)
210911	1	10	95	2	2,5	25	65	41	70	51	5	200
210912	2	10	95	2	2,5	25	65	41	70	51	5	200
210921	1	10	95	2	2,5	35	71	50	50	55	2,5	200
210922	1	16	150	2	2,5	35	81	52	52	60	5,5	280
210923	1	50	240	2	6	95	120	87	112	92	8,5	400
210924	2	10	95	2	2,5	35	71	50	50	55	5,5	200
210925	2	16	150	2	2,5	35	81	52	52	60	5,5	280
210926	2	50	240	2	6	95	120	87	112	92	8,5	400
210931	1	10	96	4	2,5	35	71	50	50	55	5,5	200
210932	1	16	150	4	2,5	35	81	52	52	60	5,5	280
210933	1	50	240	4	6	95	120	87	112	92	8,5	400
210934	2	10	95	4	2,5	35	71	50	50	55	5,5	200
210935	2	16	150	4	2,5	35	81	52	52	60	5,5	280
210936	2	50	240	4	6	95	120	87	112	92	8,5	400

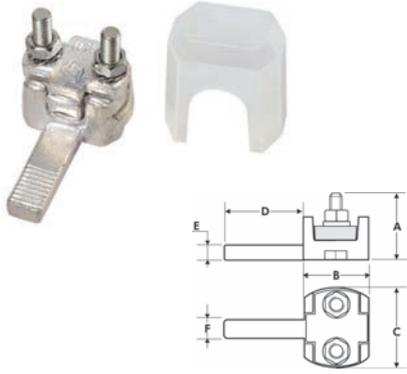

BORNAS BIMETÁLICAS DE PUNTA

CÓDIGO	ENVASE EMBALAJE	DESCRIPCIÓN	€/ud
210601	20	Borna de punta BPU-50 con capuchón	6,57
210604	20	Borna de punta BPU-50 D con capuchón	9,20

CÓDIGO	DIMENSIONES (mm)						I _n (A)
	A	B	C	D	E	F	
210601	30	18	28	27	5	7,5	125
210604	30	19	28	27	5	7,5	125

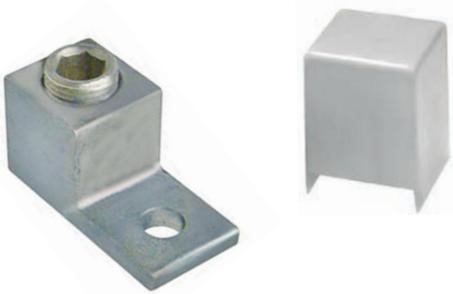

BORNAS DE PALA

CÓDIGO	ENVASE EMBALAJE	DESCRIPCIÓN	€/ud
210711	25	Borna de pala BPA - 25	18,54
210712	20	Borna de pala BPA - 70	21,50
210713	10	Borna de pala BPA - 95	27,57
210714	5	Borna de pala BPA - 150	35,14

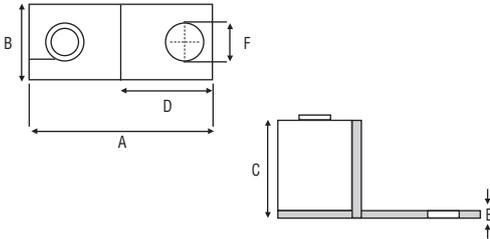

CÓDIGO	DIMENSIONES (mm)						Sección
	A	B	C	D	E	F	
210711	35,5	14	17	18	3	7	25
210712	145	18	22,5	22	4,5	9	70
210713	56	25	30	28	5,5	11	95
210714	64	30	35	32	5	11	150



REGLETAS DE CONEXIÓN

CÓDIGO	ENVASE EMBALAJE	DESCRIPCIÓN	€/ud
211002	10	Regleta REB - 6 mm. blanca	2,14
211003	10	Regleta REB - 10 mm. blanca	2,67
211004	10	Regleta REB - 16 mm. blanca	4,24
211005	10	Regleta REB - 25 mm. blanca	10,80
211007	10	Regleta REN - 6 mm. negra	2,14
211008	10	Regleta REN - 10 mm. negra	2,67
211009	10	Regleta REN - 16 mm. negra	4,24
211010	10	Regleta REN - 25 mm. negra	10,80



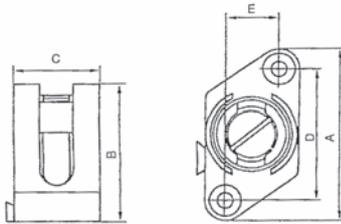

BORNAS DE CONEXIÓN

CÓDIGO	ENVASE EMBALAJE	DESCRIPCIÓN	€/ud
211039	20	Borna conexión BC - 6 mm.	3,64
211040	20	Borna conexión BC - 10 mm.	5,18
211041	20	Borna conexión BC - 16 mm.	7,06
211043	20	Borna conexión BC - 25/35 mm.	8,85
211045	20	Borna conexión BC - 50 mm.	15,88
211046	20	Borna conexión BC - 70 mm.	20,98
211047	10	Borna conexión BC - 95 mm.	36,38

SECCIÓN	DIMENSIONES (mm)				
	A	B	C	D	E
BC- 6 mm	33	25	16	24	7
BC-10 mm	38	28	16	28	6
BC-16 mm	42	32	19	32	9
BC-35 mm	46	38	23	34	11
BC-50 mm	52	45	27	40	15
BC-70 mm	55	50	30	40	15
BC-95 mm	58	54	33	40	20

Nota: cada borna admite hasta 2 conductores de la sección indicada

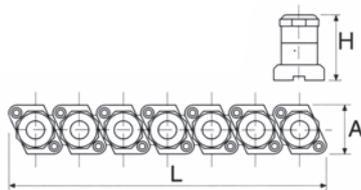

REGLETA BORNA DE CONEXIÓN

CÓDIGO	ENVASE EMBALAJE	DESCRIPCIÓN	€/ud
211051	20	Regleta borna conexión RBC - 10x6 mm.	9,43
211052	10	Regleta borna conexión RBC - 10x10 mm.	13,87
211053	10	Regleta borna conexión RBC - 10x16 mm.	16,85
211054	10	Regleta borna conexión RBC - 10x25 mm.	27,94
211055	10	Regleta borna conexión RBC - 10x35 mm.	34,26

CÓDIGO	DIMENSIONES (mm)			SECCIÓN mm ²
	A	H	L	
211051	28,5	19,5	164	6
211052	28,5	24	204	10
211053	28,5	27,2	214	16
211054	28,5	29,3	224	25
211055	28,5	34,2	261	35



CONEXIÓN AEREAS 500V.

CÓDIGO	ENVASE EMBALAJE	DESCRIPCIÓN	€/ud
211025	25	Regleta conex. aéreas RBCA-10x2,5 mm.	2,29
211026	25	Regleta conex. aéreas RBCA-10x4 mm.	2,78
211027	25	Regleta conex. aéreas RBCA-10x6 mm.	3,25
211028	10	Regleta conex. aéreas RBCA-10x10 mm.	6,29
211029	10	Regleta conex. aéreas RBCA-5x16 mm.	6,78
211036	5	Borna conex. aéreas BCA - 1x25 mm.	5,77
211037	5	Borna conex. aéreas BCA - 1x35 mm.	7,30



BORNAS DE PASO

CÓDIGO	ENVASE EMBALAJE	DESCRIPCIÓN	€/ud
210731	100	Borna de paso BPT-2.5 Gris	0,84
210732	100	Borna de paso BPT-2.5 Azul	0,84
210733	100	Borna de paso BPT-4 Gris	0,75
210734	100	Borna de paso BPT-4 Azul	0,75
210735	100	Borna de paso BPT-6 Gris	1,16
210736	100	Borna de paso BPT-6 Azul	1,16
210737	50	Borna de paso BPT-10 Gris	1,27
210738	50	Borna de paso BPT-10 Azul	1,27
210739	50	Borna de paso BPT-16 Gris	1,82
210740	50	Borna de paso BPT-16 Azul	1,82
210741	20	Borna de paso BPT-35 Gris	3,29
210742	20	Borna de paso BPT-35 Azul	3,29
210743	10	Borna de paso BPT-70 Gris	10,23
210744	10	Borna de paso BPT-70 Azul	10,23

TAPAS PARA BORNAS

CÓDIGO	ENVASE EMBALAJE	DESCRIPCIÓN	€/ud
210750	50	Tapa borna TBP-2.5 Gris	0,84
210751	50	Tapa borna TBP-2.5 Azul	0,84
210752	50	Tapa borna TBP-4 Gris	0,46
210753	50	Tapa borna TBP-4 Azul	0,46
210754	50	Tapa borna TBP-6/10 Gris	0,70
210755	50	Tapa borna TBP-6/10Azul	0,70
210756	50	Tapa borna TBP-16 Gris	0,76
210757	50	Tapa borna TBP-16 Azul	0,76
210758	50	Tapa borna TBP-35 Gris	1,16
210759	50	Tapa borna TBP-35 Azul	1,16

La borna de 70 no precisa tapa

BORNAS DE PASO TIERRA

CÓDIGO	ENVASE EMBALAJE	DESCRIPCIÓN	€/ud
210770	20	Borna paso TT. BPTT-2.5 Amarillo-verde	4,35
210771	20	Borna paso TT. BPTT-4 Amarillo-verde	4,35
210772	20	Borna paso TT. BPTT-6 Amarillo-verde	5,15
210773	20	Borna paso TT. BPTT-10 Amarillo-verde	5,49
210774	20	Borna paso TT. BPTT-16 Amarillo-verde	7,59
210775	20	Borna paso TT. BPTT-35 Amarillo-verde	10,19
210776	10	Borna paso TT. BPTT-70 Amarillo-verde	20,32

SEPARADORES BORNAS

CÓDIGO	ENVASE EMBALAJE	DESCRIPCIÓN	€/ud
210760	50	Separador borna SBP-2.5	0,46
210761	50	Separador borna SBP-4	0,64
210762	50	Separador borna SBP-6/10	0,88
210763	50	Separador borna SBP-16	0,94
210764	50	Separador borna SBP-35	1,38



TOPE FINAL

CÓDIGO	ENVASE EMBALAJE	DESCRIPCIÓN	€/ud
210766	50	Tope final TOP-2,5/35	0,77
210767	50	Tope final TOP-35/70	1,54

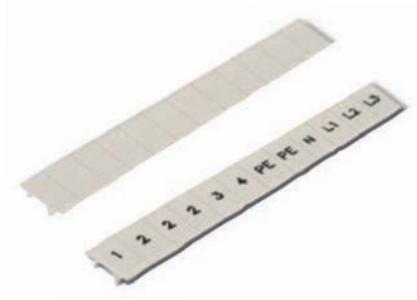

SEÑALIZADORES PARA BORNAS

CÓDIGO	ENVASE EMBALAJE	DESCRIPCIÓN	€/ud
210780	100	Señalizador borna SE-2,5 neutra	0,11
210781	100	Señalizador borna SE-4 neutra	0,11
210782	100	Señalizador borna SE-6 neutra	0,11
210783	100	Señalizador borna SE-10 neutra	0,11
210784	100	Señalizador borna SE-16 neutra	0,11
210785	100	Señalizador borna SE-35 neutra	0,11
210786	100	Señalizador borna SE-70 neutra	0,11



BORNAS PORTAFUSIBLES

CÓDIGO	ENVASE EMBALAJE	DESCRIPCIÓN	€/ud
210791	25	Borna portafusible 5x20 - 4 mm.	6,71
210792	10	Borna portafusible 6,3x32 - 4 mm.	10,04



CONEXIONES RÁPIDAS REUTILIZABLES

CÓDIGO	ENVASE EMBALAJE	DESCRIPCIÓN	€/ud
211091	50	Conexión rápida 2C 2,5/4 mm.	0,41
211092	50	Conexión rápida 3C 2,5/4 mm.	0,52
211093	50	Conexión rápida 5C 2,5/4 mm.	0,85



Intensidad: 32 A.
Tensión: 600 V



CONEXIONES CERÁMICAS

CÓDIGO	ENVASE EMBALAJE	DESCRIPCIÓN	I. Máx.	€/ud
211076	50	Conexión cerámica 2 x 4 mm.	32A.	2,07
211078	50	Conexión cerámica 2 x 10 mm.	57A.	2,39
211079	50	Conexión cerámica 2 x 16 mm.	76A.	2,97
211081	50	Conexión cerámica 3 x 4 mm.	32A.	2,55
211083	50	Conexión cerámica 3 x 10 mm.	57A.	3,15
211084	50	Conexión cerámica 3 x 16 mm.	76A.	4,05



TERMINALES COBRE PRESIÓN

CÓDIGO	ENVASE EMBALAJE	DESCRIPCIÓN	SECC./MET	€/envase
211201	100/2000	Envase 100 terminales	TCU - 1,5/4	28,60
211202	100/2000	Envase 100 terminales	TCU - 1,5/5	28,60
211203	100/2000	Envase 100 terminales	TCU - 1,5/6	29,47
211204	100/2000	Envase 100 terminales	TCU - 2,5/4	32,22
211205	100/2000	Envase 100 terminales	TCU - 2,5/5	32,22
211206	100/1500	Envase 100 terminales	TCU - 2,5/6	32,22
211207	100/1000	Envase 100 terminales	TCU - 2,5/8	33,62
211208	100/1400	Envase 100 terminales	TCU - 4/4	37,53
211209	100/1400	Envase 100 terminales	TCU - 4/5	37,53
211210	100/1000	Envase 100 terminales	TCU - 4/6	37,53
211211	100/1000	Envase 100 terminales	TCU - 4/8	39,67
211212	100/1000	Envase 100 terminales	TCU - 6/4	38,60
211213	100/1000	Envase 100 terminales	TCU - 6/5	38,60
211214	100/1000	Envase 100 terminales	TCU - 6/6	38,60
211215	100/1000	Envase 100 terminales	TCU - 6/8	41,97
211216	100/500	Envase 100 terminales	TCU - 10/5	44,29
211217	100/500	Envase 100 terminales	TCU - 10/6	44,29
211218	100/600	Envase 100 terminales	TCU - 10/8	44,29
211219	100/400	Envase 100 terminales	TCU - 10/10	59,03
211220	100/500	Envase 100 terminales	TCU - 16/5	51,04
211221	100/500	Envase 100 terminales	TCU - 16/6	51,04
211222	100/400	Envase 100 terminales	TCU - 16/8	51,04
211223	100/400	Envase 100 terminales	TCU - 16/10	57,99
211224	100/300	Envase 100 terminales	TCU - 16/12	69,20
211225	50/250	Envase 50 terminales	TCU - 25/6	36,38
211226	50/250	Envase 50 terminales	TCU - 25/8	36,38
211227	50/250	Envase 50 terminales	TCU - 25/10	39,88
211228	50/250	Envase 50 terminales	TCU - 25/12	47,30
211229	50/250	Envase 50 terminales	TCU - 35/6	55,38
211230	50/250	Envase 50 terminales	TCU - 35/8	55,38
211231	50/150	Envase 50 terminales	TCU - 35/10	58,13
211232	50/200	Envase 50 terminales	TCU - 35/12	60,19
211233	50/300	Envase 50 terminales	TCU - 35/14	70,89
211237	20/240	Envase 20 terminales	TCU - 50/6	31,75
211238	20/240	Envase 20 terminales	TCU - 50/8	31,75
211239	20/100	Envase 20 terminales	TCU - 50/10	31,75
211240	20/100	Envase 20 terminales	TCU - 50/12	31,75
211241	20/200	Envase 20 terminales	TCU - 50/14	36,28
211242	20/100	Envase 20 terminales	TCU - 70/8	45,53
211243	20/80	Envase 20 terminales	TCU - 70/10	45,53
211244	20/80	Envase 20 terminales	TCU - 70/12	45,53
211245	20/60	Envase 20 terminales	TCU - 70/14	51,57
211246	20/60	Envase 20 terminales	TCU - 70/16	52,55
211247	20/60	Envase 20 terminales	TCU - 95/8	64,02
211248	20/60	Envase 20 terminales	TCU - 95/10	64,02
211249	20/40	Envase 20 terminales	TCU - 95/12	64,02
211250	20/40	Envase 20 terminales	TCU - 95/14	69,33
211251	20/40	Envase 20 terminales	TCU - 95/16	69,33
211252	10/40	Envase 10 terminales	TCU - 120/10	52,65
211253	10/40	Envase 10 terminales	TCU - 120/12	52,65
211254	10/30	Envase 10 terminales	TCU - 120/14	52,65
211255	10/30	Envase 10 terminales	TCU - 120/16	52,65
211256	10/30	Envase 10 terminales	TCU - 150/10	68,83
211257	10/30	Envase 10 terminales	TCU - 150/12	68,83
211258	10/30	Envase 10 terminales	TCU - 150/14	68,83
211259	10/30	Envase 10 terminales	TCU - 150/16	68,83
211260	10/30	Envase 10 terminales	TCU - 185/10	91,24
211261	10/20	Envase 10 terminales	TCU - 185/12	91,24
211262	10/20	Envase 10 terminales	TCU - 185/14	91,24
211263	10/10	Envase 10 terminales	TCU - 185/16	91,24
211264	5/15	Envase 5 terminales	TCU - 240/12	60,58
211265	5/15	Envase 5 terminales	TCU - 240/14	60,58
211266	5/10	Envase 5 terminales	TCU - 240/16	60,58

SECC= Sección del conductor.
MET= Métrica admisible.

MANGUITOS COBRE PRESIÓN

CÓDIGO	ENVASE EMBALAJE	DESCRIPCIÓN	€/envase
211301	100/2000	Envase 100 manguitos MCU - 1,5	25,98
211302	100/1500	Envase 100 manguitos MCU - 2,5	29,44
211303	100/1000	Envase 100 manguitos MCU - 4	42,55
211304	100/800	Envase 100 manguitos MCU - 6	46,83
211305	100/500	Envase 100 manguitos MCU - 10	52,75
211306	100/400	Envase 100 manguitos MCU - 16	66,45
211307	50/600	Envase 50 manguitos MCU - 25	42,12
211308	50/150	Envase 50 manguitos MCU - 35	59,32
211310	20/100	Envase 20 manguitos MCU - 50	31,45
211311	20/140	Envase 20 manguitos MCU - 70	49,94
211312	20/100	Envase 20 manguitos MCU - 95	64,80
211313	10/90	Envase 10 manguitos MCU - 120	53,92
211314	10/70	Envase 10 manguitos MCU - 150	65,02
211315	10/50	Envase 10 manguitos MCU - 185	91,94
211316	5/30	Envase 5 manguitos MCU - 240	62,25



TERMINALES TORNILLERÍA

CÓDIGO	ENVASE EMBALAJE	DESCRIPCIÓN	€/ud
211701	20	Término tor. recto TER-10/50	12,72
211702	10	Término tor. recto TER-25/120	23,30
211703	10	Término tor. recto TER-70/150 (1)	30,34
211704	5	Término tor. recto TER-150/240	35,96
211705	4	Término tor. recto TER-240/400	65,56
211711	20	Término tor. escuadra TEE-10/50 (2)	21,73
211712	10	Término tor. escuadra TEE-25/120	35,43
211721	20	Término tor. unión TU-10/50	16,36
211722	10	Término tor. unión TU-25/120 (3)	32,91
211723	10	Término tor. unión TU-70/150	42,39
211731	10	Término tor. derivación TD-10/50	16,70
211732	10	Término tor. derivación TD-25/120 (4)	35,43
211733	10	Término tor. derivación TD-70/150	40,48



GRAPA DERIVACIÓN

CÓDIGO	ENVASE EMBALAJE	DESCRIPCIÓN	€/ud
211151	50	Grapa derivación GD1T-16	2,70
211152	50	Grapa derivación GD1T-50	4,69
211153	20	Grapa derivación GD1T-70	10,21
211154	10	Grapa derivación GD2T-95	22,63
211155	7	Grapa derivación GD2T-150	39,13

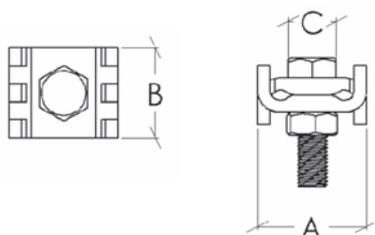

CÓDIGO	DIMENSIONES (mm)			SECC. CABLES	
	A	B	C	Min (mm ²)	Max (mm ²)
211151	25,30	21,20	M6	6	16
211152	30	24,30	M8	25	50
211153	40,25	30,30	M8	50	70
211154	51,65	53	M10	70	95
211155	53,25	53	M10	95	150

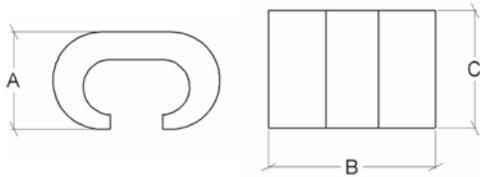

PETACA DERIVACIÓN COBRE

CÓDIGO	ENVASE EMBALAJE	DESCRIPCIÓN	€/ud
211134	50	Petaca derivación PD-CU 25/16	2,38
211135	50	Petaca derivación PD-CU 25/25	2,38
211136	20	Petaca derivación PD-CU 35/25	4,53
211137	20	Petaca derivación PD-CU 35/35	4,42
211139	20	Petaca derivación PD-CU 70/70	7,86
211143	10	Petaca derivación PD-CU 120/70	14,56
211144	10	Petaca derivación PD-CU 120/95	14,50

CÓDIGO	DIMENSIONES (mm)			SECC. CABLES	
	A	B	C	Principal	Derivado
211134	11,70	19,60	16,10	16/25	16/16
211135	11,70	20,40	16,10	16/25	16/25
211136	15,30	25	19	25/35	16/35
211137	15,30	26,80	19,50	35/35	35/35
211139	20,10	34	24,25	50/70	50/70
211143	24,50	41,50	27,30	95/120	50/70
211144	24,50	40	27,30	95/120	95/120

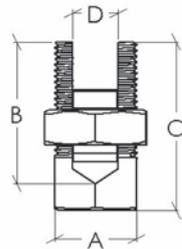

BORNE APRIETAHILOS COBRE

CÓDIGO	ENVASE EMBALAJE	DESCRIPCIÓN					€/ud
			A	B	C	D	
211103	50	Aprietahilos CU-16	12,70	20,55	25,25	5,70	3,84
211104	50	Aprietahilos CU-25	15,90	21,20	28,50	7,60	5,69
211105	40	Aprietahilos CU-35	17,90	28	35	7,80	6,16
211106	20	Aprietahilos CU-50	23,90	36	42	10,20	7,04
211107	10	Aprietahilos CU-70	23,90	39,15	47,40	11,40	8,77
211108	10	Aprietahilos CU-95	26,90	42,30	50	14,30	18,40
211109	10	Aprietahilos CU-120	28,60	49,80	59,20	15,70	25,11
211110	5	Aprietahilos CU-185	32,10	49,80	59,20	18	41,63



BORNE APRIETAHILOS LATÓN

CÓDIGO	ENVASE EMBALAJE	DESCRIPCIÓN					€/ud
			A	B	C	D	
211111	50	Aprietahilos LA-16	12,70	20,55	25,25	5,70	2,93
211112	50	Aprietahilos LA-25	15,90	21,20	28,50	7,60	4,03
211113	40	Aprietahilos LA-35	17,90	28	35	7,80	4,89
211114	20	Aprietahilos LA-50	23,90	36	42	10,20	6,36
211115	10	Aprietahilos LA-70	23,90	39,15	47,40	11,40	7,94
211116	10	Aprietahilos LA-95	26,90	42,30	50	14,30	15,28
211117	10	Aprietahilos LA-120	28,60	49,80	59,20	15,70	21,28
211118	5	Aprietahilos LA-185	32,10	49,80	59,20	18	35,60

PUNTERAS

CÓDIGO	ENVASE EMBALAJE	DESCRIPCIÓN	€/envase		
			A	B	
211801	100/2000	Envase 100 punteras P - 0,5 blanca	1,0	8,0	7,95
211802	100/2000	Envase 100 punteras P - 0,75 azul	1,2	8,2	7,95
211803	100/2000	Envase 100 punteras P - 1 roja	1,4	8,2	7,95
211804	100/2000	Envase 100 punteras P - 1,5 negra	1,7	8,2	8,91
211805	100/2000	Envase 100 punteras P - 2,5 gris	2,2	8,2	11,10
211806	100/2000	Envase 100 punteras P - 4 naranja	2,8	9,3	14,55
211807	100/1000	Envase 100 punteras P - 6 verde	3,5	12	18,20
211808	100/500	Envase 100 punteras P - 10 marrón	4,5	12	24,27
211809	100/500	Envase 100 punteras P - 16 marfil	5,8	12	31,53
211810	50/200	Envase 50 punteras P - 25 negra	7,3	16	27,90
211811	50/200	Envase 50 punteras P - 35 roja	8,3	16	37,60
211812	50/100	Envase 50 punteras P - 50 azul	10,3	20	58,21



PUNTERAS LARGAS

CÓDIGO	ENVASE EMBALAJE	DESCRIPCIÓN	€/envase		
			A	B	
211821	100/500	Envase 100 punteras largas PL - 0,5 blanca	1,0	10,0	11,35
211822	100/500	Envase 100 punteras largas PL - 0,75 azul	1,2	12,0	11,35
211823	100/500	Envase 100 punteras largas PL - 1 roja	1,4	12,0	11,35
211824	100/500	Envase 100 punteras largas PL - 1,5 negra	1,7	18	12,75
211825	100/500	Envase 100 punteras largas PL - 2,5 gris	2,2	18	15,84
211826	100/500	Envase 100 punteras largas PL - 4 naranja	2,8	18	20,77
211827	100/500	Envase 100 punteras largas PL - 6 verde	3,5	18	25,99
211828	100/400	Envase 100 punteras largas PL - 10 marrón	4,5	18	34,52
211829	100/400	Envase 100 punteras largas PL - 16 marfil	5,8	18	44,76
211830	50/100	Envase 50 punteras largas PL - 25 negra	7,3	22	39,85
211831	50/100	Envase 50 punteras largas PL - 35 roja	8,3	25	53,71
211832	50	Envase 50 punteras largas PL - 50 azul	10,3	25	83,14



PUNTERAS DUO

CÓDIGO	ENVASE EMBALAJE	DESCRIPCIÓN	€/envase
211901	100/1000	Envase 100 punteras DUO P-2x0,50	15,13
211902	100/1000	Envase 100 punteras DUO P-2x0,75	15,13
211903	100/1000	Envase 100 punteras DUO P-2x1,00	15,13
211904	100/1000	Envase 100 punteras DUO P-2x1,50	16,40
211905	100/1000	Envase 100 punteras DUO P-2x2,50	18,02
211906	100/500	Envase 100 punteras DUO P-2x4,00	43,67
211907	100/500	Envase 100 punteras DUO P-2x6,00	66,94
211908	100/300	Envase 100 punteras DUO P-2x10,00	87,32
211909	50/100	Envase 50 punteras DUO P-2x16,00	50,94



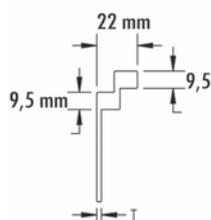
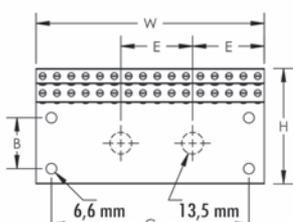
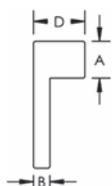
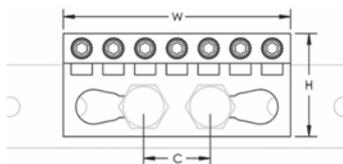

REGLETA UNIVERSAL DISTRIBUIDORA

CÓDIGO	ENVASE EMBALAJE	DESCRIPCIÓN	€/ud
220401	10	Regleta de conexión 7 C para pletina CU	17,31

**Siete conexiones de 1,5 hasta 16 mm².
Capacidad de corriente hasta 450 A.**

CÓDIGO	DIMENSIONES (mm)				
	W	H	D	A	B
220401	68	31	12,5	9	4
				M5	M6
Cota "C"		18	17,5/25	20/25	25

REGLETA UNIVERSAL DISTRIBUIDORA ALUMINIO

CÓDIGO	ENVASE EMBALAJE	DESCRIPCIÓN	€/ud
220425	10	Regleta de conexión ALU-14C 450 A	7,92
220426	10	Regleta de conexión ALU-20C 640 A	10,85
220427	10	Regleta de conexión ALU-32C 1020 A	17,17

CÓDIGO	DIMENSIONES (mm)				
	W	H	E	C	B
220425	61,5	72	-	36	31,8
220426	88	72	-	62,8	31,8
220427	141,5	72	44,5	122,5	31,8

**Conexiones de 1,5 hasta 6 mm².
Material: Aluminio estañado
Válido para cable de cobre y aluminio**

REGLETAS AISLADAS, CONEXIÓN Y DISTRIBUCIÓN

CÓDIGO	ENVASE EMBALAJE	DESCRIPCIÓN	€/ud
220411	2/32	Conexiones CTN - 7 (1)	10,55
220412	2/32	Conexiones CTN - 14	13,85
220413	1/16	Conexiones CTN - 28	26,43
220421	20	Conexiones TN - 7 (2)	5,72
220422	12	Conexiones TN - 11	7,24
220423	10	Conexiones TN - 15	9,02
220414	10	Conexiones ETN - 7 (3)	8,10
220415	10	Conexiones ETN - 12	10,43
220416	10	Conexiones ETN - 15	12,45

CÓDIGO	BARRAS	Nº ORIFICIOS	DIAM. ORIFICIOS MM.	DIMENSIONES
220411	1x7	7	7xD5,3 mm	51x47x39
220412	2x7	14	14xD5,3 mm	51x47x39
220413	2x14	28	28xD5,3 mm	51x34x19
220421	1x7	7	5xD5,3 - 2xD6 mm	59x20x34
220422	1x11	11	9xD5,3 - 2xD6 mm	88x34x19
220423	1x15	15	13xD5,3 - 2xD6 mm	104x34x19
220414	1x7	7	1xD6,5 - 6xD5,5 mm	57x7x9
220415	1x12	12	1xD6,5 - 11xD5,5 mm	92x7x9
220416	1x15	15	1xD6,5 - 14xD5,5 mm	113x7x9

Aptas para carril DIN

REGLETAS CONEXIÓN Y DISTRIBUCIÓN

CÓDIGO	ENVASE EMBALAJE	DESCRIPCIÓN	€/ud
220402	20	Regleta conexión 8+2	(1) 5,59
220403	10	Regleta conexión 10+2	6,23
220404	10	Regleta conexión 36	(2) 29,95
220405	10	Regleta conexión 168	38,51
220409	1	Regleta conexión 20	(2) 29,99
220406	1	Regleta conexión 44	41,51
220410	1	Regleta conexión 60	46,18
220407	1	Kit montaje perfil R 20/44/60	11,18
220408	1	Kit unión 2 R 20/44/60	10,49
220430	5	Regleta conexión 130	(2) 120,48
220431	1	Regleta conexión 2x130	(3) 188,38
220432	10	Soporte para RC130	(4) 5,59
220433	10	Conector 130-35 mm ²	(5) 3,56
220434	10	Conector 130-70 mm ²	(5) 4,60
220435	10	Regleta conexión 142	(6) 57,65
220436	10	Regleta conexión 166	(6) 37,54
220437	10	Soporte para 1x142/166	(7) 1,03
220438	10	Soporte para 2x142/166	(8) 1,91
220439	10	Conector 142-35 mm ²	(9) 0,64
220440	10	Conector 166-25 mm ²	(9) 0,83

CÓDIGO	DIMENSIONES (mm)		
	Amp	Sección	Núm. conex.
220430	125	1,5-25	130
220431	200	1,5-25	260
220535	63	1,5-16	142
220536	40	1,5-10	166

Cotas y datos Técnicos
página 137

REGLETAS CONEXIÓN ALUMINIO

CÓDIGO	ENVASE EMBALAJE	DESCRIPCIÓN	L mm.	€/ud
220460	10	Regleta conex. aluminio 2AL	24,10	2,12
220461	10	Regleta conex. aluminio 4AL	47,80	3,78
220462	10	Regleta conex. aluminio 6AL	65,00	5,23
220463	10	Regleta conex. aluminio 10AL	96,80	7,68
220464	10	Regleta conex. aluminio 12AL	112,50	8,83
220465	10	Regleta conex. aluminio 20AL	176,00	14,15

Material: aluminio estañado, válido para cable de cobre y aluminio
Sección conductor 2,5-16 mm.²

PLETINAS CONEXIÓN DERIVACION CON TORNILLOS

CÓDIGO	ENVASE EMBALAJE	DESCRIPCIÓN	€/ud
220501	10	Pletina derivación PDT-12x3-T 58 M6 DIN84	31,19
220502	10	Pletina derivación PDT-15x4 T 40 M8 DIN933	52,40
220503	10	Pletina derivación PDT-15x4 T 54 M6 DIN985	52,40

Material: latón estañado
63 Amperios (12x3) 100 Amperios (15x4)

Longitud 1000 mm.





Conector monobloque

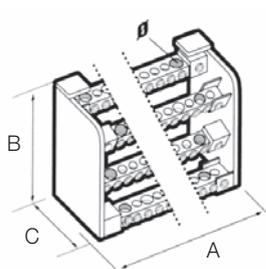
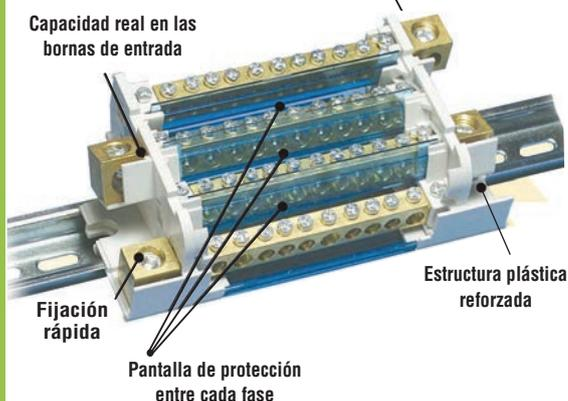

1

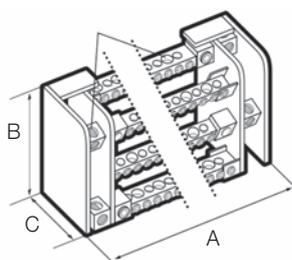

2

BLOQUES REPARTIDORES 2 POLOS

CÓDIGO	ENVASE EMBALAJE	DESCRIPCIÓN	€/ud
220444	1	Repartidor 2 polos RM - 100/7	15,17
220443	1	Repartidor 2 polos RM - 100/15	29,79
220445	1	Repartidor 2 polos RM - 125/7	15,65
220446	1	Repartidor 2 polos RM - 125/15	31,87

BLOQUES REPARTIDORES 4 POLOS

CÓDIGO	ENVASE EMBALAJE	DESCRIPCIÓN	€/ud
220450	1	Repartidor 4 polos RT - 100/7	24,69
220447	1	Repartidor 4 polos RT - 100/11	32,07
220448	1	Repartidor 4 polos RT - 100/15	43,06
220449	1	Repartidor 4 polos RT - 125/7	25,89
220451	1	Repartidor 4 polos RT - 125/11	33,66
220452	1	Repartidor 4 polos RT - 125/15	45,35
220453	1	Repartidor 4 polos RT - 160/12 50mm	107,62
220454	1	Repartidor 4 polos RT - 160/12	107,62
220455	1	Repartidor 4 polos RT - 250-400/15	212,49

CÓDIGO DIMENSIONES (mm)

CÓDIGO	DIMENSIONES (mm)			
	A	B	C	
220444	64	50	50	(1)
220443	130	50	50	(1)
220445	94	50	50	(2)
220446	162	50	50	(2)
220450	64	90	50	(1)
220447	100	90	50	(1)
220448	130	90	50	(1)
220449	109	90	50	(2)
220451	147	90	50	(2)
220452	182	90	50	(2)
220453	175	90	50	(2)
220454	170	90	70	(2)
220455	224	121	156	(2)

RM100/7

ENTRADA	10-25	x1
SALIDAS	0,75P/1,5C-4	x3
SALIDAS	1,5P/2,5C-6	x3

RM100/15

ENTRADA	10-25	x2
SALIDAS	0,75P/1,5C-4	x6
SALIDAS	1,5P/2,5C-6	x7

RM125/7

ENTRADA	10-35	x1
SALIDAS	1,5P/2,5C-6	x5
SALIDAS	6P/10C-25	x1

RM125/15

ENTRADA	10-35	x1
SALIDAS	1,5P/2,5C-6	x11
SALIDAS	6P/10C-25	x3

RT100/7

ENTRADA	10-25	x1
SALIDAS	0,75P/1,5C-4	x3
SALIDAS	1,5P/2,5C-6	x3

RT100/11

ENTRADA	10-25	x2
SALIDAS	0,75P/1,5C-4	x4
SALIDAS	1,5P/2,5C-6	x5

RT100/15

ENTRADA	10-25	x2
SALIDAS	0,75P/1,5C-4	x6
SALIDAS	1,5P/2,5C-6	x7

RT125/7

ENTRADA	10-35	x1
SALIDAS	1,5P/2,5C-6	x5
SALIDAS	6P/10C-25	x1

RT125/11

ENTRADA	10-35	x1
SALIDAS	1,5P/2,5C-6	x7
SALIDAS	6P/10C-25	x3

RT125/15

ENTRADA	10-35	x1
SALIDAS	1,5P/2,5C-6	x11
SALIDAS	6P/10C-25	x1
SALIDAS	10-25P/35C	x2

RT160/12

ENTRADA	10-50	x1
SALIDAS	10-25P/35C	x3
SALIDAS	1,5P/2,5C-16	x8

RT250-400/15

ENTRADA	35-120	x1
SALIDAS	10-35P/50C	x1
SALIDAS	10-25P/35C	x2
SALIDAS	6-16P/25C	x4
SALIDAS	2,5-10P/16C	x7

RT160/12-50

ENTRADA	10-50	x1
SALIDAS	10-25P/35C	x3
SALIDAS	1,5P/2,5C-6	x1
SALIDAS	1,5P/2,5C-16	x7

BARRAS DE NEUTRO

CÓDIGO	ENVASE EMBALAJE	DESCRIPCIÓN	€/ud
220456	1	Barra de neutro aislada 125	11,32
220457	1	Barra de neutro aislada 160	13,18

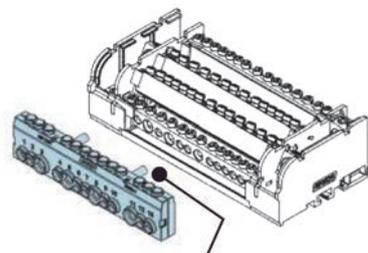

Fijación mecánica y conexión eléctrica.



CONJUNTO REPARTIDOR ENSAMBLADO 125-630 A.

CÓDIGO	ENVASE EMBALAJE	DESCRIPCIÓN	€/ud
220470	1	Conjunto repartidor 4P TR 125 A	149,65
220471	1	Conjunto repartidor 4P TRS 160 A	189,66
220472	1	Conjunto repartidor 4P TR 250 A	191,39
220473	1	Conjunto repartidor 4P TR 400 A	224,90
220474	1	Conjunto repartidor 4P TRC 400 A	249,74
220475	1	Conjunto repartidor 4P TRC 630 A	342,78



220470	
Barras roscadas	12 x 4 mm.
T. aislamiento	Ui= 1000v

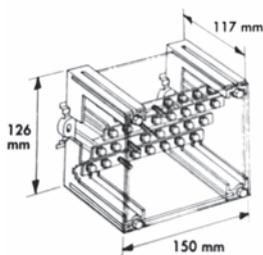

220471	
Barras roscadas	15 x 5 mm.
T. aislamiento	Ui= 630v

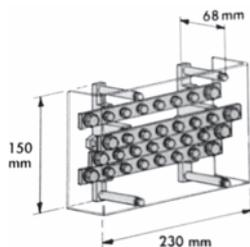

220472	
Barras roscadas	20 x 5 mm.
T. aislamiento	Ui= 630v

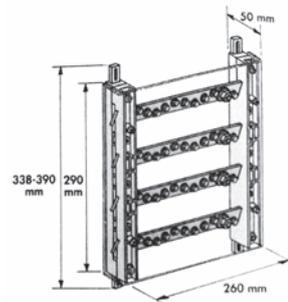

220473	
Barras roscadas	32 x 5 mm.
T. aislamiento	Ui= 1000v

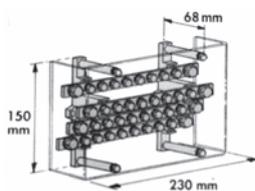

220474	
Barras roscadas	32 x 5 mm.
T. aislamiento	Ui= 1000v

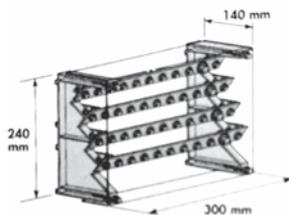

220475	
Barras roscadas	30 x 10 mm.
T. aislamiento	Ui= 1000v

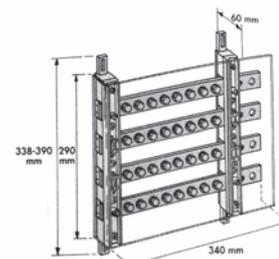

Disponemos de los elementos individuales para el montaje de cualquier tipo de embarrado. Ver elementos en página 64.



BLOQUE REPARTIDOR UNIPOLAR "F" ECO

CÓDIGO	ENVASE EMBALAJE	DESCRIPCIÓN	€/ud
220155	1	Bloque Repartidor Unip. "F" BQ-125	26,50
220156	1	Bloque Repartidor Unip. "F" BQ-175	38,60
220157	1	Bloque Repartidor Unip. "F" BQ-250	48,53
220158	1	Bloque Repartidor Unip. "F" BQ-400	52,30

**Tensión máxima: IEC 60947-7-1:100 V AC/ 1500 V. DC
UL 1953: 600 V. AC/DC**

125 A.

ENTRADA	10-35	x1
SALIDAS	2,5-25	x1
SALIDAS	2,5-16	x6

175 A.

ENTRADA	10-70	x1
SALIDAS	2,5-25	x6

250 A.

ENTRADA	35-120	x1
SALIDAS	2,5-35	x2
SALIDAS	2,5-16	x5
SALIDAS	2,5-10	x4

400 A.

ENTRADA	95-185	x1
SALIDAS	2,5-35	x2
SALIDAS	2,5-16	x5
SALIDAS	2,5-10	x4



BLOQUE REPARTIDOR UNIPOLAR "F"

CÓDIGO	ENVASE EMBALAJE	DESCRIPCIÓN	€/ud
220150	1	Bloque Repartidor Unip. "F" PDB-80	18,25
220151	1	Bloque Repartidor Unip. "F" PDB-125	25,25
220152	1	Bloque Repartidor Unip. "F" PDB-175	35,80
220153	1	Bloque Repartidor Unip. "F" PDB-250	47,50
220154	1	Bloque Repartidor Unip. "F" PDB-400	49,20

**Tensión máxima: IEC 60947-7-1:100 V AC/ 1500 V. DC
UL 1953: 1000 V. AC/DC**

80 A.

ENTRADA	2,5-25	x1
SALIDAS	2,5-10	x6

125 A.

ENTRADA	2,5-50	x1
SALIDAS	2,5-25	x6

250 A.

ENTRADA	35-120	x1
SALIDAS	2,5-35	x6

175 A.

ENTRADA	2,5-70	x1
SALIDAS	2,5-25	x4

400 A.

ENTRADA	70-240	x1
SALIDAS	2,5-35	x6

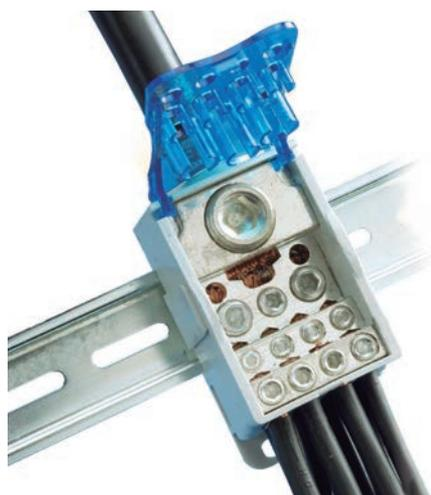

BLOQUE REPARTIDOR UNIVERSAL

CÓDIGO	ENVASE EMBALAJE	DESCRIPCIÓN	€/ud
220171	1	Bloque Repartidor Unip. "E" BQE-80	19,52
220172	1	Bloque Repartidor Unip. "E" BQE-125	37,37
220173	1	Bloque Repartidor Unip. "E" BQE-160	60,80
220174	1	Bloque Repartidor Unip. "E" BQE-250	79,90
220175	1	Bloque Repartidor Unip. "E" BQE-400	86,26
220177	1	Interconexión 125/160	3,76
220178	1	Conector 250	12,28
220179	1	Conector 400	12,75

80 A.



80 A.	ENTRADA	6-16	x1
	SALIDAS	2,5-6	x4
	SALIDAS	2,5-16	x2

125/160 A.

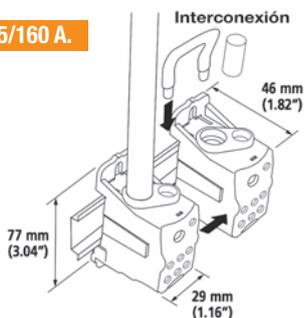

125 A.	ENTRADA	10-35	x1
	SALIDAS	6-16	x1
	SALIDAS	2,5-16	x4P ó 6C

160 A.	ENTRADA	10-70	x1
	SALIDAS	6-16	x1
	SALIDAS	2,5-16	x4P ó 6C

250/400 A.

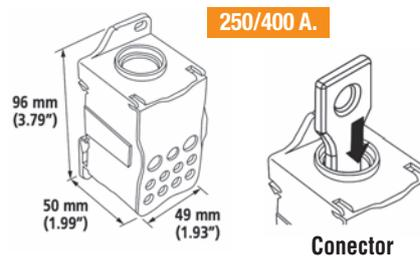

250 A.	ENTRADA	35-120	x1
	SALIDAS	6-35C/25P	x2
	SALIDAS	2,5-16	x5
	SALIDAS	2,5-10	x4

400 A.	ENTRADA	95-185	x1
	SALIDAS	6-35C/25P	x2
	SALIDAS	2,5-16	x5
	SALIDAS	2,5-10	x4



BLOQUE UNIPOLAR REPARTIDOR PLETINA FLEXIBLE

CÓDIGO	ENVASE EMBALAJE	DESCRIPCIÓN	€/ud
220161	1	Bloque Unip. Plet, Flexible BQP-250	77,27
220162	1	Bloque Unip. Plet, Flexible BQP-500	92,22

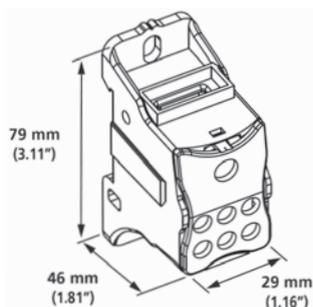

250 A.

Entrada Pletina Flexible

3 x 9 x 0,8 - 6 x 9 x 0,8
3 x 13 x 0,5 - 6 x 13 x 0,5
2 x 15,5 x 0,8 - 6 x 15,5 x 0,8

SALIDAS	2,5-16	x6
---------	--------	----

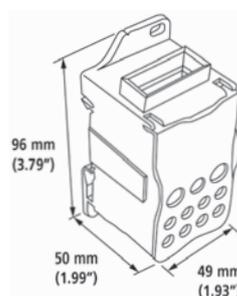

500 A.

Entrada Pletina Flexible

4 x 15,5 x 0,8 - 6 x 15,5 x 0,8
2 x 20 x 1 - 6 x 20 x 1
2 x 24 x 1 - 8 x 24 x 1

SALIDAS	2,5-16	x5
SALIDAS	2,5-10	x4
SALIDAS	6-35C/25P	x2



1



2



3



4



5

BLOQUE REPARTIDOR CABLE GRAN POTENCIA

CÓDIGO	ENVASE EMBALAJE	DESCRIPCIÓN		€/ud
220231	1	Bloque Repartidor 6C 500AL / 715 A.	(1)	94,61
220232	1	Bloque Repartidor 6C 630AL / 705 A.	(2)	106,04
220233	1	Bloque Repartidor 2C12C 630AL / 1010 A.	(3)	112,79
220234	1	Bloque Repartidor 2C12C 1000AL / 1070 A.	(4)	121,55
220235	1	Bloque Repartidor 2C9C 1250AL / 1740 A.	(5)	185,74



6C500AL
715 A - IEC
380 A -

1

De un cable a seis cables

- Icw kA rms 1s: 34.3
- Ipk kA: 52.5
- Ui: 1000 VAC IEC
- Ui: 1500 VDC IEC
- Vin: 1000 VAC/DC UL

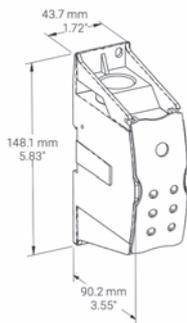

9C630AL
705 A - IEC
420 A -

2

De un cable a nueve cables

- Icw kA rms 1s: 32.2
- Ipk kA: 52.5
- Ui: 1000 VAC IEC
- Ui: 1500 VDC IEC
- Vin: 1000 VAC/DC UL

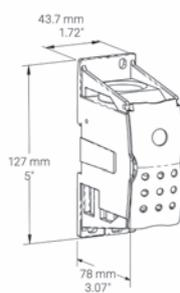

2C12C630AL
1010 A - IEC
670 A -

3

De dos cables a doce cables

- Icw kA rms 1s: 42.9
- Ipk kA: 52.5
- Ui: 1000 VAC IEC
- Ui: 1500 VDC IEC
- Vin: 1000 VAC/DC UL

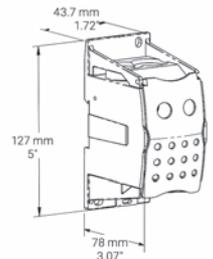

2C12C1000AL
1070 A - IEC
760 A -

4

De dos cables a doce cables

- Icw kA rms 1s: 42.9
- Ipk kA: 73.5
- Ui: 1000 VAC IEC
- Ui: 1500 VDC IEC
- Vin: 1000 VAC/DC UL

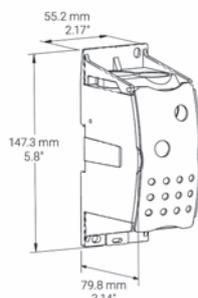

2C9C1250AL
1740 A - IEC
950 A -

5

De dos cables a nueve cable

- Icw kA rms 1s: 84
- Ipk kA: 73.5
- Ui: 1000 VAC IEC
- Ui: 1500 VDC IEC
- Vin: 1000 VAC/DC UL

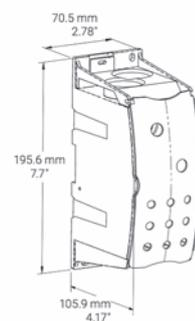



1



2



3



4



5

BLOQUE REPARTIDOR PLETINA GRAN POTENCIA

CÓDIGO	ENVASE EMBALAJE	DESCRIPCIÓN	€/ud
220221	1	Bloque Repartidor F6C 500AL / 775 A.	(1) 104,10
220222	1	Bloque Repartidor F9C 500AL / 710 A.	(2) 116,62
220223	1	Bloque Repartidor F12C 500AL/ 780 A.	(3) 124,08
220224	1	Bloque Repartidor F12C 800AL / 885 A.	(4) 133,68
220225	1	Bloque Repartidor F9C 1000AL / 1450 A.	(5) 194,94



1 F6C500AL
775 A - IEC
Pletina flexible
545 A - IEC
Trenza aislada
475 A - UL

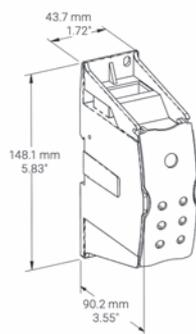

De un conductor plano a seis cables

- Icw kA rms 1s: 34.3
- Ipk kA: 52.5
- Ui: 1000 VAC IEC
- Ui: 1500 VDC IEC
- Vin: 1000 VAC/DC UL

2 F9C500AL
710 A - IEC
Pletina flexible
510 A - IEC
Trenza aislada
490 A - UL

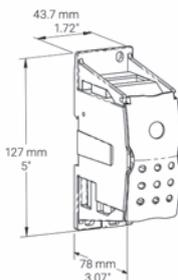

De un conductor plano a nueve cables

- Icw kA rms 1s: 32.2
- Ipk kA: 52.5
- Ui: 1000 VAC IEC
- Ui: 1500 VDC IEC
- Vin: 1000 VAC/DC UL

3 F12C500AL
780 A - IEC
Pletina flexible
550 A - IEC
Trenza aislada
500 A - UL

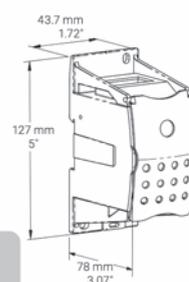

De un conductor plano a doce cables

- Icw kA rms 1s: 34.3
- Ipk kA: 52.5
- Ui: 1000 VAC IEC
- Ui: 1500 VDC IEC
- Vin: 1000 VAC/DC UL

4 F12C800AL
885 A - IEC
Pletina flexible
800 A - IEC
Trenza aislada
670 A - UL

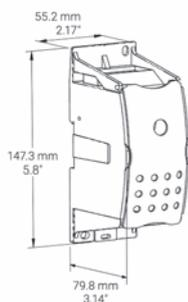

De un conductor plano a doce cables

- Icw kA rms 1s: 42.9
- Ipk kA: 73.5
- Ui: 1000 VAC IEC
- Ui: 1500 VDC IEC
- Vin: 1000 VAC/DC UL

5 F9C1000AL
1450 A - IEC
Pletina flexible
1100 A - IEC
Trenza aislada
840 A - UL

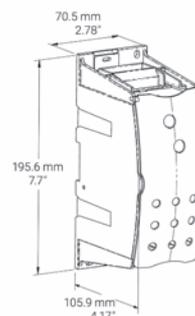

De un conductor plano a nueve cables

- Icw kA rms 1s: 71.5
- Ipk kA: 73.5
- Ui: 1000 VAC IEC
- Ui: 1500 VDC IEC
- Vin: 1000 VAC/DC UL

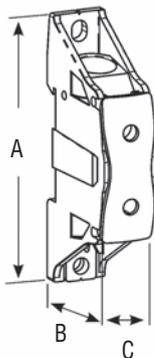

BLOQUE UNIPOLAR DE POTENCIA CABLE 1 SALIDA

CÓDIGO	ENVASE EMBALAJE	DESCRIPCIÓN	€/ud
220190	1	Bloque Potencia BQCP-80/110A 1E-1S	14,66
220191	1	Bloque Potencia BQCP-125/170A 1E-1S	22,86
220192	1	Bloque Potencia BQCP-160/250A 1E-1S	32,47
220193	1	Bloque Potencia BQCP-250/400A 1E-1S	54,17
220194	1	Bloque Potencia BQCP-400/500A 1E-1S	80,38
220196	1	Bloque Potencia BQCP-630/870A 1E-1S	205,06

BLOQUE UNIPOLAR DE POTENCIA CABLE 2 SALIDAS

CÓDIGO	ENVASE EMBALAJE	DESCRIPCIÓN	€/ud
220197	1	Bloque Potencia BQCP-250/550A 1E-2S	92,16
220195	1	Bloque Potencia BQCP-400/600A 1E-2S	123,02
220198	1	Bloque Potencia BQCP-1000/1020A 1E-2S	128,95
220199	1	Bloque Potencia BQCP-1000/1150A 2E-2S	136,68

BLOQUE UNIPOLAR DE POTENCIA ENTRADA PLETINA FLEXIBLE

CÓDIGO	ENVASE EMBALAJE	DESCRIPCIÓN	€/ud
220210	1	Bloque Potencia BPF-250/380A 1E-1S	58,83
220211	1	Bloque Potencia BPF-400/445A 1E-1S	82,89
220212	1	Bloque Potencia BPF-400/560A 1E-2S	124,35
220213	1	Bloque Potencia BPF-630/805A 1E-1S	199,17
220214	1	Bloque Potencia BPF-630/930A 1E-2S	102,93
220215	1	Bloque Potencia BPF-1000/1420A 1E-3S	149,10
220216	1	Bloque Potencia BPF-1600/1940A 1E-4S	225,36

CÓDIGO	DIMENSIONES (mm)			ENTRADA	SALIDAS
	A	B	C		
220190	83,9	42	17,3	1x 2,5-6R/6-16F	1x 2,5-6R/6-16F
220191	84	47,1	20,2	1x 10-35	1x 10-35
220192	111,1	55	27,7	1x 35-70	1x 35-70
220193	111	58	31,5	1x 35-120	1x 35-120
220194	146,4	82	41,5	1x 95-240	1x 95-240
220196	174,4	89,4	54,2	1x 240-500	1x 240-500
220197	148	83	35	1x 35-120	2x 35-120
220195	146,4	82	41,5	1x 95-240	2x 35-120
220198	191	109	54	1x 240-500	2x 35-300
220199	223	110	44	2x 35-300	2x 35-300
220210	111	58	31	1x (c)*	1x 35-120
220211	146,4	82	41,5	1x (a)*	1x 95-240
220212	146,4	82,2	41,5	1x (a)*	2x 35-120
220213	174,4	89,4	54,2	1x (b)*	1x 240-500
220214	191	103	54	1x (b)*	2x 35-240
220215	176	112	70	1x (d)*	3x 35-300
220216	176	112	99	1x (e)*	4x 35-300

(a)* Pletinas: 2x20x1 - 5x24x1 (b)* Pletinas: 2x20x1 - 8x32x1. (c)* Pletinas: 2x20x1 - 5x20x1
 (d)* Pletinas: 2x20x1 - 10x50x1 (e)* Pletinas: 6x50x1 - 10x80x1



BLOQUE UNIPOLAR REPARTIDOR HUERTOS SOLARES

CÓDIGO	ENVASE EMBALAJE	DESCRIPCIÓN	€/ud
220201	1	Bloque conex. BHS-CU 400A 2E/12S	103,86
220202	1	Bloque conex. BHS-AL 400A 2E/12S	44,64
220205	1	Bloque conex. BHS-CU 400A 1E/12S	103,02
220206	1	Bloque conex. BHS-AL 400A 1E/12S	45,09
220204	1	Interconexión 400A	15,16

ENTRADA	35-95	x2
SALIDAS	2,5-10	x12

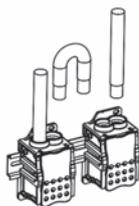
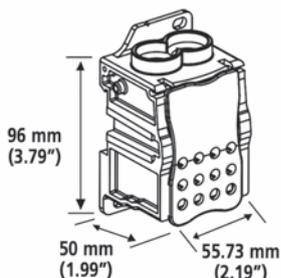

ENTRADA	95-185	x1
SALIDAS	2,5-10	x12

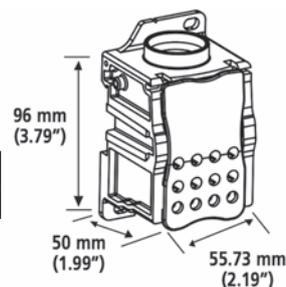

BLOQUE UNIPOLAR POTENCIA CONEX. TORNILLOS

CÓDIGO	ENVASE EMBALAJE	DESCRIPCIÓN	€/ud
210800	5	Bornes potencia BPC-70	17,34
210801	5	Bornes potencia BPC-95	20,31
210802	5	Bornes potencia BPC-120	21,05
210803	5	Bornes potencia BPC-150	24,47
210804	5	Bornes potencia BPC-240	31,91
210805	5	Tapa protección borne TBPC	10,78



BLOQUE UNIPOLAR DE POTENCIA "F" PROTEGIDOS

CÓDIGO	ENVASE EMBALAJE	DESCRIPCIÓN	€/ud
210822	10	Bloque de potencia F-50 gris	20,25
210823	10	Bloque de potencia F-50 azul	20,25
210828	10	Bloque de potencia F-70 gris	24,75
210829	10	Bloque de potencia F-70 azul	24,75
210834	10	Bloque de potencia F-95 gris	29,70
210835	10	Bloque de potencia F-95 azul	29,70
210840	5	Bloque de potencia F-120 gris	35,96
210841	5	Bloque de potencia F-120 azul	35,96
210846	5	Bloque de potencia F-150 gris	42,35
210847	5	Bloque de potencia F-150 azul	42,35
210858	5	Bloque de potencia F-240 gris	48,60
210859	5	Bloque de potencia F-240 azul	48,60





BORNE UNIPOLAR KVIAC FASE

CÓDIGO	ENVASE EMBALAJE	DESCRIPCIÓN	€/ud
220316	10	Borna KVIAC - 11016 Gris 1E - 1S	8,06
220301	10	Borna KVIAC - 11035 Gris 1E - 1S	9,42
220304	10	Borna KVIAC - 11050 Gris 1E - 1S	10,60
220307	10	Borna KVIAC - 11095 Gris 1E - 1S	15,98
220310	10	Borna KVIAC - 11150 Gris 1E - 1S	24,93
220313	3	Borna KVIAC - 11240 Gris 1E - 1S	39,78



BORNE UNIPOLAR KVIAC NEUTRO

CÓDIGO	ENVASE EMBALAJE	DESCRIPCIÓN	€/ud
220317	10	Borna KVIAC - 11016 Azul 1E - 1S	8,06
220302	10	Borna KVIAC - 11035 Azul 1E - 1S	9,42
220305	10	Borna KVIAC - 11050 Azul 1E - 1S	10,60
220308	10	Borna KVIAC - 11095 Azul 1E - 1S	15,98
220311	10	Borna KVIAC - 11150 Azul 1E - 1S	24,93
220314	3	Borna KVIAC - 11240 Azul 1E - 1S	39,78



BORNE UNIPOLAR KVIAC TIERRA

CÓDIGO	ENVASE EMBALAJE	DESCRIPCIÓN	€/ud
220318	10	Borna KVIAC - 11016 AV 1E - 1S	8,06
220303	10	Borna KVIAC - 11035 AV 1E - 1S	9,42
220306	10	Borna KVIAC - 11050 AV 1E - 1S	10,60
220309	10	Borna KVIAC - 11095 AV 1E - 1S	15,98
220312	10	Borna KVIAC - 11150 AV 1E - 1S	24,93
220315	3	Borna KVIAC - 11240 AV 1E - 1S	39,78

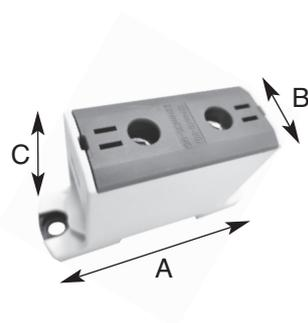

SECCIÓN	DIMENSIONES (mm)			MÁXIMO AMPERAJE	
	A	B	C	COBRE	ALUMINIO
16	44,6	13,5	39,5	82 A.	75 A.
35	46	16	40	135 A.	120 A.
50	49	18	43	160 A.	145 A.
95	84	24,8	51	250 A.	220 A.
150	84	30,9	54	320 A.	290 A.
240	106	37,1	65	425 A.	380 A.



BORNE UNIPOLAR KVIAC 1/2 FASE

CÓDIGO	ENVASE EMBALAJE	DESCRIPCIÓN	€/ud
220319	10	Borna KVIAC - 12035 Gris 1E - 2S	15,98
220322	10	Borna KVIAC - 12050 Gris 1E - 2S	17,73
220325	10	Borna KVIAC - 12095 Gris 1E - 2S	26,78
220328	5	Borna KVIAC - 12150 Gris 1E - 2S	37,58
220331	3	Borna KVIAC - 12240 Gris 1E - 2S	67,68



BORNE UNIPOLAR KVIAC 1/2 NEUTRO

CÓDIGO	ENVASE EMBALAJE	DESCRIPCIÓN	€/ud
220320	10	Borna KVIAC - 12035 Azul 1E - 2S	15,98
220323	10	Borna KVIAC - 12050 Azul 1E - 2S	17,73
220326	10	Borna KVIAC - 12095 Azul 1E - 2S	26,78
220329	5	Borna KVIAC - 12150 Azul 1E - 2S	37,58
220332	3	Borna KVIAC - 12240 Azul 1E - 2S	67,68



BORNE UNIPOLAR KVIAC 1/2 TIERRA

CÓDIGO	ENVASE EMBALAJE	DESCRIPCIÓN	€/ud
220321	10	Borna KVIAC - 12035 AVI 1E - 2S	15,98
220324	10	Borna KVIAC - 12050 AVI 1E - 2S	17,73
220327	10	Borna KVIAC - 12095 AVI 1E - 2S	26,78
220330	5	Borna KVIAC - 12150 AVI 1E - 2S	37,58
220333	3	Borna KVIAC - 12240 AVI 1E - 2S	67,68

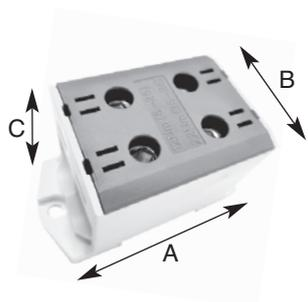

SECCIÓN	DIMENSIONES (mm)			MÁXIMO AMPERAJE	
	A	B	C	COBRE	ALUMINIO
35	46	27	40	135 A.	120 A.
50	49	30	43	160 A.	145 A.
95	84	41,8	51	250 A.	220 A.
150	84	50,9	54	320 A.	290 A.
240	106	60,1	65	425 A.	380 A.

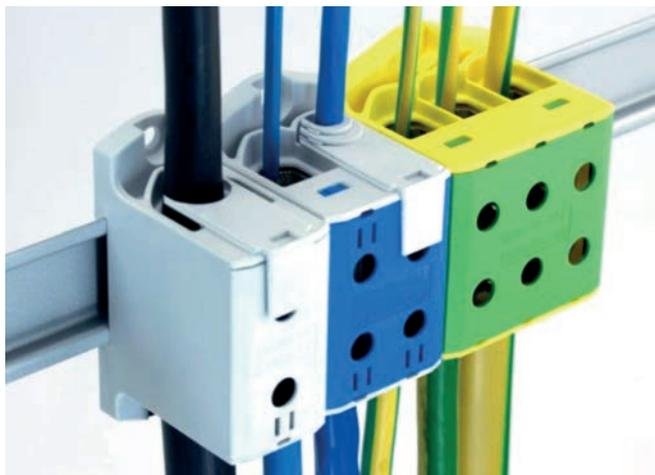

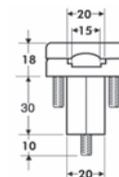
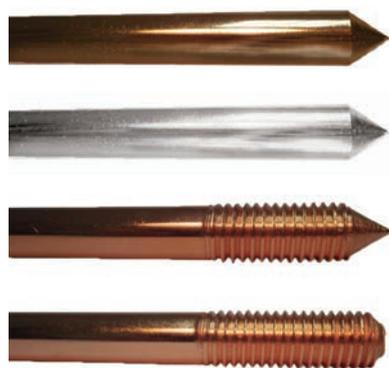

PICAS Y ACCESORIOS

CÓDIGO	ENVASE EMBALAJE	DESCRIPCIÓN	€/ud
240101	10	Pica PT - 1,5/14mm - 100 micras	21,95
240102	5	Pica PT - 2/14mm - 100 micras	28,88
240103	5	Pica PT - 2 roscada 18mm - 100 micras	51,98
240111	5	Pica PTI - 1,5/16 mm INOXIDABLE	90,00
240112	5	Pica PTI - 2/16 mm INOXIDABLE	110,00
240201	10	Brida tierra 14 ECO	(1) 3,31
240202	20	Brida tierra 14	(2) 4,04
240204	10	Brida tierra 18	(2) 7,30
240208	10	Brida tierra 16 INOXIDABLE	(2) 12,00
240206	10	Manguito unión pica 18	(3) 12,00
240207	10	Tornillo 18	(4) 7,50
310504	20	Aislador ABE-30	(5) 4,30
240209	1	Garrafa 25 Litros plus conductividad	(6) 330,00

Datos técnicos páginas 138

REGISTROS DE TIERRA

CÓDIGO	ENVASE EMBALAJE	DESCRIPCIÓN	€/ud
240221	10	Arqueta APT-20 BOXTAR	(1) 20,21
240222	12	Arqueta AMT-20 metálica	(2) 21,23

(1) Poliéster reforzado FV
(2) Fundición de aluminio

Ver cotas en página 54

PLACAS DE TIERRA

CÓDIGO	ENVASE EMBALAJE	DESCRIPCIÓN	€/ud
240301	2	Placa PPT - 500x500x2	(1) 51,98
240302	2	Placa PPT - 1000x500x2	(1) 86,63
240303	2	Placa PPT - 500x500x3	(1) 70,46
240304	2	Placa PPT - 1000x500x3	(1) 125,89
240305	2	Placa PPTC - 500x500x2 cobre	(2) 212,23
240306	2	Placa PPTC - 1000x500x2 cobre	(2) 439,59
240307	2	Placa PPTI - 500x500x2 INOX	(3) 136,00
240309	2	Placa Estrella de cobre	(4) 133,03



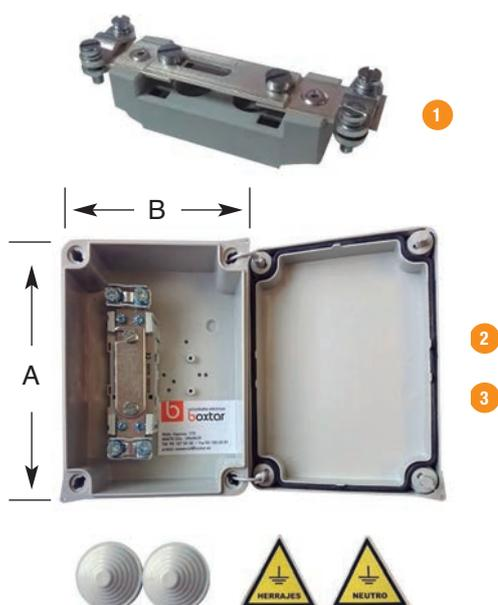

SECCIONAMIENTO DE TIERRA

CÓDIGO	ENVASE EMBALAJE	DESCRIPCIÓN		€/ud
240501	6	Puente de corte tierra PCT	(1)	12,71
240506-IB	24	Caja corte tierra CCT - 1/1 opaca	(2)	22,24
240507-IB	24	Caja corte tierra CCT - 1/1 transparente	(2)	23,09
240508	24	Caja corte tierra CCT - 1/2 opaca	(2)	31,13
240509	24	Caja corte tierra CCT - 1/2 transparente	(2)	32,32
240510	5	Caja corte tierra CCT-25/95 - 1/1 opaca	(3)	57,42
240511	5	Caja corte tierra CCT-25/95 - 1/1 transparente	(3)	62,98
240516	1	Caja corte de tierra CT-BUC	(4)	77,26

DIMENSIONES (mm)

	A	B	Profundidad
(2)	160	115	65
(3)	220	170	85
(4)	235	175	100

Datos técnicos páginas 138

TRENZA DE COBRE

CÓDIGO	ENVASE EMBALAJE	DESCRIPCIÓN	INTENSIDAD MÁX (A)	€/m
240401	25	Mts. trenza de cobre 10mm.	85	14,62
240402	25	Mts. trenza de cobre 16mm.	120	21,08
240403	25	Mts. trenza de cobre 25mm.	150	34,49
240404	25	Mts. trenza de cobre 35mm.	180	45,86
240405	25	Mts. trenza de cobre 50mm.	280	59,21

TRENZA DE COBRE ESTAÑADA

CÓDIGO	ENVASE EMBALAJE	DESCRIPCIÓN	INTENSIDAD MÁX (A)	€/m
240411	25	Mts. trenza de cobre 10mm. estañada	85	18,26
240412	25	Mts. trenza de cobre 16mm. estañada	120	26,37
240413	25	Mts. trenza de cobre 25mm. estañada	150	43,13
240414	25	Mts. trenza de cobre 35mm. estañada	180	57,34
240415	25	Mts. trenza de cobre 50mm. estañada	280	74,01

CONEXIONES DE COBRE ESTAÑADAS

CÓDIGO	ENVASE EMBALAJE	DESCRIPCIÓN Sección mm ² x Longitud	INTENSIDAD MÁX (A)	€/ud
240421	10	Conexión 10x200 M6 estañada	85	31,72
240422	10	Conexión 10x250 M6 estañada	85	32,98
240423	10	Conexión 16x200 M8 estañada	120	32,58
240424	10	Conexión 16x250 M8 estañada	120	36,76
240425	10	Conexión 25x200 M8 estañada	150	41,37
240426	10	Conexión 25x250 M8 estañada	150	43,88
240427	10	Conexión 35x200 M10 estañada	180	43,03
240428	10	Conexión 35x250 M10 estañada	180	45,41
240429	10	Conexión 50x200 M10 estañada	280	52,13
240430	10	Conexión 50x250 M10 estañada	280	56,66

Otras medidas consultar
Ejecuciones especiales



UNIDAD DE CONTROL

CÓDIGO	ENVASE EMBALAJE	DESCRIPCIÓN	€/ud
240601	1	Unidad de control PLUSCU2L6 (cable 1,8 mts)	455,88
240602	1	Unidad de control PLUSCU2L15 (cable 4,5 mts)	545,49
240603	1	Cable de repuesto 1,8 mts	84,55
240604	1	Cable de repuesto 4,5 mts	149,33
240605	1	Adaptador de repuesto AA	168,81
240606	1	Adaptador de batería Dewalt	173,26
240607	1	Adaptador de batería Milwaukee	189,34

- Incluye baterías alcalinas AA para alimentar aproximadamente 600 conexiones
- Batería recargable de Milwaukee o de walt, se pueden utilizar para alimentar aprox. 1500 conexiones con una batería 4 Ah.
- Retraso de 5 segundos en la ignición, que le permite al usuario detenerla si fuera necesario.
- Temperatura de trabajo -18 a 54 grados C°

CARGAS PLUS

CÓDIGO	ENVASE EMBALAJE	DESCRIPCIÓN	€/ud
240610	10	Cargas Plus 32PLUSF20 Blanco	9,44
240611	10	Cargas Plus 45PLUSF20 Azul Claro	12,13
240612	10	Cargas Plus 65PLUSF20 Verde Oscuro	14,64
240613	10	Cargas Plus 90PLUSF20 Gris	19,88
240614	10	Cargas Plus 115PLUSF20 Naranja	23,62
240615	10	Cargas Plus 150PLUSF20 Azul Oscuro	28,02
240616	10	Cargas Plus 200PLUSF20 Amarillo	35,76
240617	10	Cargas Plus 250PLUSF20 Morado	43,12
240618	10	Cargas Plus 300PLUSF20 Verde Claro	50,19
240619	10	Cargas Plus 400PLUSF20 Café	66,93
240620	10	Cargas Plus 500PLUSF20 Café Claro	85,95

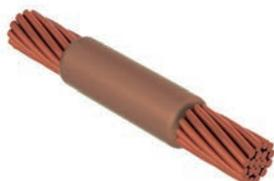

MOLDE CABLE A PICA TT

CÓDIGO	ENVASE EMBALAJE	DESCRIPCIÓN	CARGA PLUS	€/ud
240630	1	Molde a Pica T.T. 35mm	90	314,89
240631	1	Molde a Pica T.T. 50mm	90	314,89

MOLDE EMPALME HORIZONTAL

CÓDIGO	ENVASE EMBALAJE	DESCRIPCIÓN	CARGA PLUS	€/ud
240632	1	Molde Empalme Horiz. 35mm	32	314,89
240633	1	Molde Empalme Horiz. 50mm	45	314,89

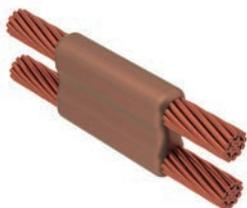

MOLDE PARALELO HORIZONTAL

CÓDIGO	ENVASE EMBALAJE	DESCRIPCIÓN	CARGA PLUS	€/ud
240634	1	Molde Paralelo Horizontal 35mm	65	314,89
240635	1	Molde Paralelo Horizontal 50mm	90	314,89



MOLDE "T" HORIZONTAL

CÓDIGO	ENVASE EMBALAJE	DESCRIPCIÓN	CARGA PLUS	€/ud
240636	1	Molde "T" Horizontal 35mm	45	314,89
240637	1	Molde "T" Horizontal 50mm	90	314,89
240638	1	Molde "T" Horizontal 95mm	115	314,89

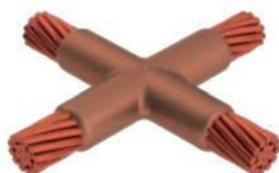

MOLDE CRUZ HORIZONTAL

CÓDIGO	ENVASE EMBALAJE	DESCRIPCIÓN	CARGA PLUS	€/ud
240639	1	Molde Cruz Horizontal 35mm	65	314,89
240640	1	Molde Cruz Horizontal 50mm	90	314,89
240641	1	Molde Cruz Horizontal 95mm	150	314,89

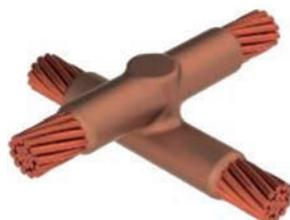

MOLDE CRUZ HORIZONTAL SUPERPUESTA

CÓDIGO	ENVASE EMBALAJE	DESCRIPCIÓN	CARGA PLUS	€/ud
240642	1	Mol. Cruz Hori. Superpuesta 35mm	90	314,89
240443	1	Mol. Cruz Hori. Superpuesta 50mm	115	314,89

No precisa corte de cable



MANGO PARA MOLDES

CÓDIGO	ENVASE EMBALAJE	DESCRIPCIÓN	€/ud
240651	1	Mango L160	265,61



PASTA SELLADORA Y LIMPIADOR MOLDE

CÓDIGO	ENVASE EMBALAJE	DESCRIPCIÓN	€/ud
240654	1	Pasta selladora	76,07
240655	1	Limpiador Molde B136A (vm=<65)	27,28
240656	1	Limpiador Molde B136B (vm=>90)	27,28



1

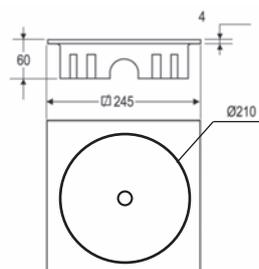

2

REGISTROS DE TIERRA

CÓDIGO	ENVASE EMBALAJE	DESCRIPCIÓN		€/ud
240221	10	Arqueta APT-20 BOXTAR	(1)	20,21
240222	12	Arqueta AMT-20 metálica	(2)	21,23

(1) **Poliéster reforzado FV**
(2) **Fundición de aluminio**



1



2

TAPAS Y ARQUETAS REGISTRO TERMOESTABLES

CÓDIGO	ENVASE EMBALAJE	DESCRIPCIÓN		€/ud
250131	1	Tapa con marco TR-20	(1)	25,30
250132	1	Tapa con marco TR-30		41,75
250133	1	Tapa con marco TR-40		83,79
250134	1	Tapa con marco TR-50		125,24
250135	1	Tapa con marco TR-70		294,40
250151	1	Arqueta completa ATR-20 ECO	(2)	37,95
250152	1	Arqueta completa ATR-30 ECO		69,58
250153	1	Arqueta completa ATR-40 ECO		120,18
250154	1	Arqueta completa ATR-50 ECO		177,10
250155	1	Arqueta completa ATR-70 ECO		442,75

	H	L	L
250151	200	195	195
250152	300	290	290
250153	400	395	395
250154	520	545	545
250155	700	690	690

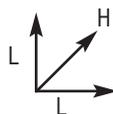

Datos técnicos página 138

DETALLE TAPA 700x700



Descripción

La tapadera tiene una fórmula de materiales, con una nervadura en las vigas en la parte inferior, para mejorar la resistencia.

Las cinco vigas se enganchan con clip.

Tiene tacos de goma antideslizantes en la superficie.

Capacidad 3,5 ton. (3500 kg), según normativa EN-124.

Material

Realizada en PP (polipropileno), refuerzo de fibra en nylon y goma.

Marco en PP (polipropileno).

Utilización

Se utiliza como alternativa a las tapas tradicionales de hormigón.

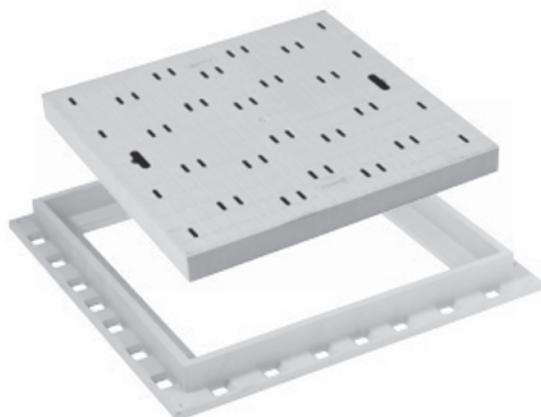



TAPAS CON MARCO REGISTRO JARDÍN

CÓDIGO	ENVASE EMBALAJE	DESCRIPCIÓN	€/ud
250181	1	Tapa con marco jardín TJ-20	29,04
250182	1	Tapa con marco jardín TJ-20 con asa	35,77
250183	1	Tapa con marco jardín TJ-30	47,92
250184	1	Tapa con marco jardín TJ-30 con asa	55,05
250185	1	Tapa con marco jardín TJ-40	94,83
250186	1	Tapa con marco jardín TJ-40 con asa	106,07
250187	1	Tapa con marco jardín TJ-50	143,45
250188	1	Tapa con marco jardín TJ-50 con asa	175,69

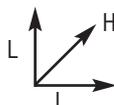

	L	L	H
250181/82	200	200	35
250183/84	300	300	40
250185/86	400	400	45
250187/88	550	550	50

Datos técnicos página 138



CUBETA REGISTRO JARDÍN CON LLAVE

CÓDIGO	ENVASE EMBALAJE	DESCRIPCIÓN	€/ud
250176	1	Cubeta registro CRJ 240x270x175	20,14
250177	1	Cubeta registro CRJ 420x320x200	37,58

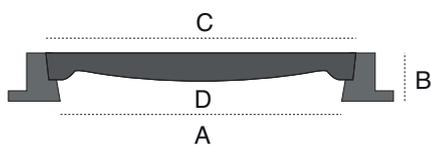

TAPAS REGISTRO DE FUNDICIÓN B-125

CÓDIGO	ENVASE EMBALAJE	DESCRIPCIÓN	€/ud
250123	1	Tapa con marco TMF-300 fundición	75,00
250114	1	Tapa con marco TMF-400 fundición	88,00
250116	1	Tapa con marco TMF-500 fundición	120,00

REFERENCIA	RESISTENCIA	LONG. EXT. A	ALTURA B	TAPA C	PASO LIBRE D
250123	B125	332 x 332	25	297 x 297	247 x 247
250114	B125	422 x 422	25,8	395 x 395	340 x 340
250116	B125	541 x 541	27	501 x 501	451 x 451



TAPAS REGISTRO DE POLIÉSTER

CÓDIGO	ENVASE EMBALAJE	DESCRIPCIÓN	€/ud
250112	1	Tapa con marco TM - 400 alumbrado (1)	110,00
250113	1	Tapa con marco TM - 400 neutra (2)	110,00
250115	1	Tapa con marco TM - 400 bicicleta (3)	110,00
250117	1	Tapa con marco TM - 400 enllumenat (4)	110,00

Datos técnicos página 139.



1



2



3

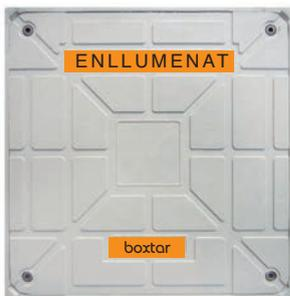
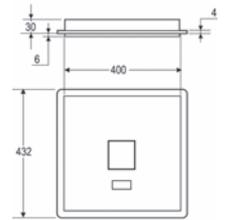

4



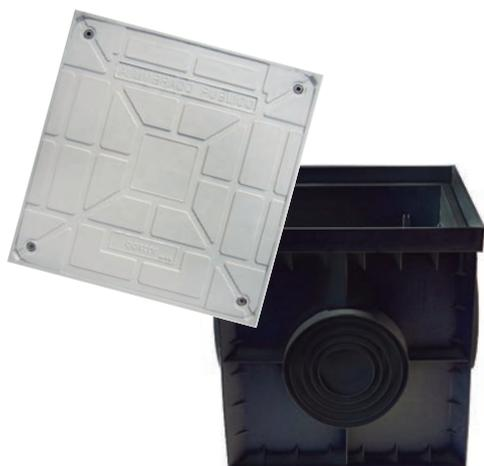

ARQUETAS CON TAPAS REGISTRO DE POLIÉSTER

CÓDIGO	ENVASE EMBALAJE	DESCRIPCIÓN	€/ud
250211	1	Arqueta completa ATM - 400 alumbrado (1)	199,00
250212	1	Arqueta completa ATM - 400 neutra (2)	199,00
250215	1	Arqueta completa ATM - 400 bicicleta (3)	199,00
250216	1	Arqueta completa ATM - 400 enlumenat (4)	199,00

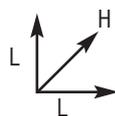

	H	L	L
Arqueta	400	375	375
Tapa	30	400	400

Se fabrican con los escudos de ayuntamientos según cantidades.
 Datos técnicos página 139



COMPOSITE ALTA RESISTENCIA

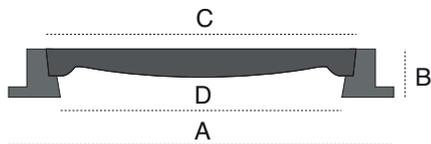

TAPAS DE REGISTRO DE COMPOSITE

CÓDIGO	ENVASE EMBALAJE	DESCRIPCIÓN	€/ud
250160	1	Tapa con marco TMC 300 B-125 (1)	135,20
250161	1	Tapa con marco TMC 420 B-125	176,40
250162	1	Tapa con marco TMC 446 B-125	228,80
250163	1	Tapa con marco TMC 511 B-125	306,80
250164	1	Tapa con marco TMC 611 B-125	421,20
250165	1	Tapa con marco TMC 660 circular D-400 (2)	738,40
250166	1	Tapa con marco TMC 720 circular C-250	447,20

- 1 Tapas con 4 cierres, consultar incrementos
- 2 Necesita llave, no incluida en el precio

Fabricado según Norma EN-124

REFERENCIA	RESISTENCIA	LONG. EXT. A	ALTURA B	TAPA C	PASO LIBRE D
250160	B125	300 x 300	38	240 x 240	205 x 205
250161	B125	420 x 420	38	340 x 340	305 x 305
250162	B125	445 x 445	38	370 x 370	330 x 330
250163	B125	510 x 510	55	455 x 455	405 x 405
250164	B125	610 x 610	55	555 x 555	505 x 505
250165	D400	800 ø	100	660 ø	600 ø
250166	C250	720 ø			



PERFILES OMEGA

CÓDIGO	ENVASE EMBALAJE	DESCRIPCIÓN	€/metro
270101	40	Perfil omega liso zincado	6,03
270102	40	Perfil omega troquelado zincado	6,25
270103	20	Perfil omega reforzado liso zincado	10,57
270104	20	Perfil omega reforzado troquelado zincado	10,85
270311	40	Perfil omega liso sendzimir	5,05
270312	40	Perfil omega troquelado sendzimir	5,25
270313	24	Perfil omega reforzado liso sendzimir	9,39
270314	24	Perfil omega reforzado troquelado sendzimir	9,67

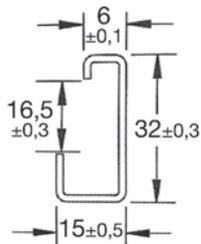
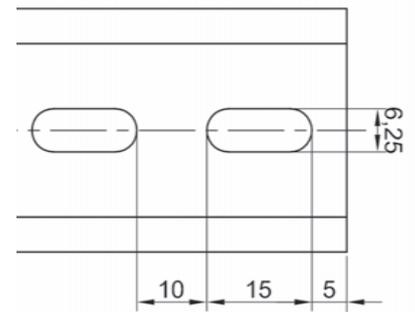
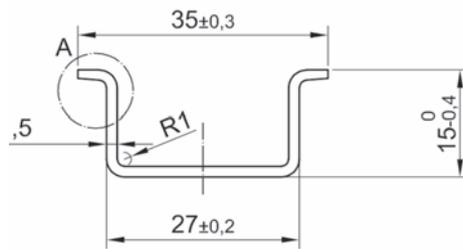
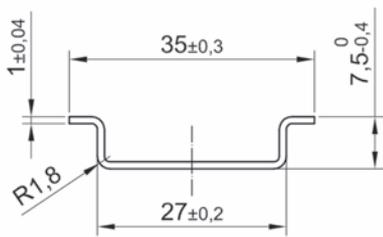

PERFIL "J"

CÓDIGO	ENVASE EMBALAJE	DESCRIPCIÓN	€/metro
270316	20	Perfil bornas "J" liso sendzimir	10,24

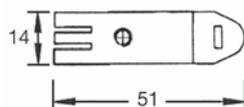

SOPORTE FIJACIÓN A PERFIL OMEGA

CÓDIGO	ENVASE EMBALAJE	DESCRIPCIÓN	€/ud
270705	100	SopORTE KLIP M5	1,50



BASE SCHUKO

CÓDIGO	ENVASE EMBALAJE	DESCRIPCIÓN	€/ud
271001	5	Base Schuko para carril	10,63



PERFILES "C"			
CÓDIGO	ENVASE EMBALAJE	DESCRIPCIÓN	€/metro
270204	40	Perfil C 10 x 20 troquelado zincado	7,04
270403	60	Perfil C 10 x 20 liso sendzimir	5,24
270405	60	Perfil C 10 x 20 troquelado sendzimir	5,44
270206	20	Perfil C 18 x 27 troquelado sendzimir	7,50
270208	20	Perfil C 20 x 40 troquelado zincado	17,05
270408	20	Perfil C 20 x 40 liso sendzimir	11,04
270409	24	Perfil C 20 x 40 troquelado sendzimir	14,43

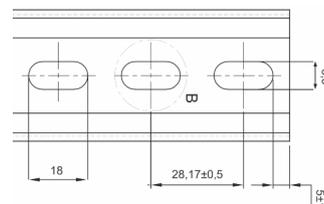
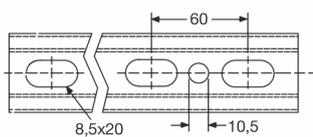
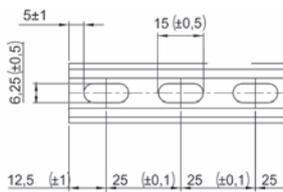
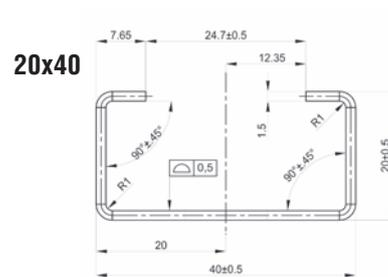
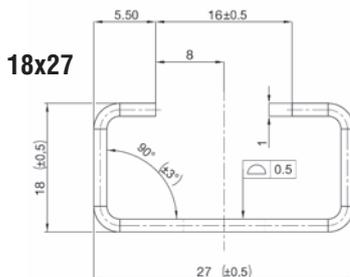
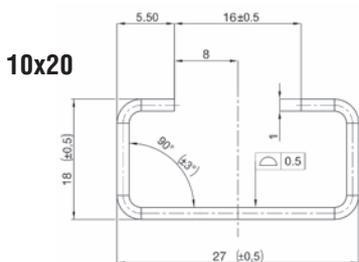

PERFILES "C" REFORZADOS			
CÓDIGO	ENVASE EMBALAJE	DESCRIPCIÓN	€/metro
270205	23,5	Perfil C 20 x 20 a 2,35 liso sendzimir	12,85
270410	12	Perfil C 21 x 41 ref. troquelado sendzimir	24,71
270411	8	Perfil C 41 x 41 ref. troquelado sendzimir	34,59
270501	8	Perfil C 21 x 41 ref. troquelado HR	47,04
270502	8	Perfil C 41 x 41 ref. troquelado HR	62,45
270711	100	Unión Perfiles 21 x 41/ 41 x 41	5,96

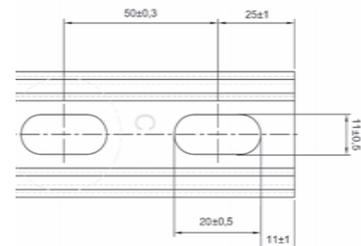
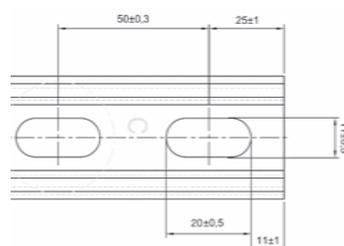
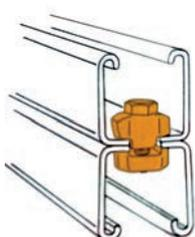
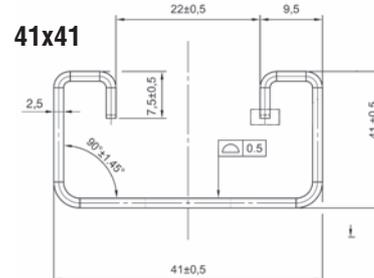
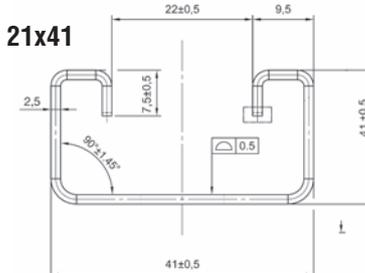
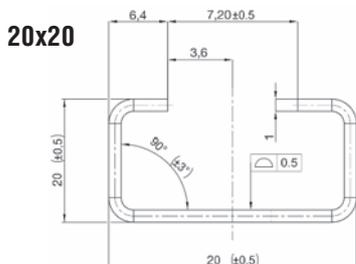



SOPORTES PERFILES

CÓDIGO	ENVASE EMBALAJE	DESCRIPCIÓN	A	€/ud
270701	10	Soporte inclinado SIP		2,50
270730	10	Soporte elevador TST-20	20 mm.	1,61
270731	10	Soporte elevador TST-25	25 mm.	1,75
270732	10	Soporte elevador TST-30	30 mm.	1,81
270733	10	Soporte elevador TST-40	40 mm.	2,14
270734	10	Soporte elevador TST-50	50 mm.	2,33
270735	10	Soporte elevador TST-70	70 mm.	3,05
270736	10	Soporte elevador TST-90	90 mm.	3,62

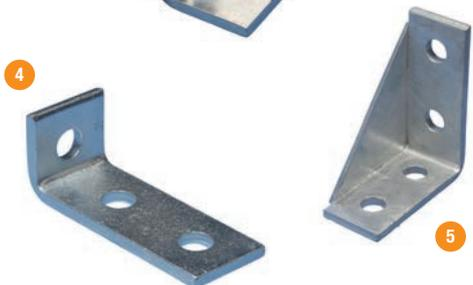
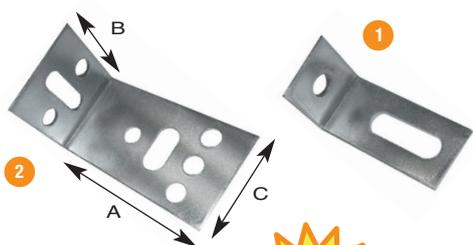
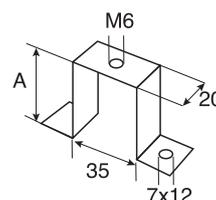
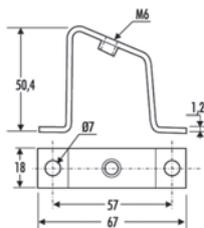

ESCUADRAS PERFILES

CÓDIGO	ENVASE EMBALAJE	DESCRIPCIÓN	€/ud
270702	50	Escuadra ES - 1020	(1) 3,79
270703	25	Escuadra ES - 2040	(2) 5,15
270721	10	Escuadra Reforzada 4258 Galv. Caliente	(3) 6,49
270722	10	Escuadra Reforzada 4899 Galv. Caliente	(4) 9,95
270724	1	Escuadra Reforzada 89106 Galv. Caliente	(5) 27,94

CÓDIGO	DIMENSIONES (mm)			COLISOS	REDONDOS
	A	B	C		
270702	45	23	20	25x60	6 mm.Ø
270703	74	40	40	20x9+25x9	7 mm.Ø
270721	58	42	40	-	14 mm.Ø
270722	99	48	40	-	14 mm.Ø
270724	106	89	40	-	14 mm.Ø

TAPA FINAL 2141-4141

CÓDIGO	ENVASE EMBALAJE	DESCRIPCIÓN	€/ud
270712	10	Tapa final 2141-4141	2,10





GRAPA ABARCÓN			
CÓDIGO	ENVASE EMBALAJE	DESCRIPCIÓN	€/ud
270713	10	Grapa Abarcón 2141-4141 Galv. Caliente	14,69

Métrica 10



TORNILLO FIJACIÓN A 21x41 / 41x41			
CÓDIGO	ENVASE EMBALAJE	DESCRIPCIÓN	€/ud
270931	100	Tuerca tornillo F41 8x30	3,99
270932	100	Tuerca tornillo F41 8x40	4,11
270933	100	Tuerca tornillo F41 8x50	4,25
270934	100	Tuerca tornillo F41 8x60	4,29
270935	100	Tuerca tornillo F41 8x100	4,77
270937	100	Tuerca tornillo F41 10x40	4,77
270938	100	Tuerca tornillo F41 10x50	4,97
270939	100	Tuerca tornillo F41 10x60	5,06
270940	100	Tuerca tornillo F41 12x40	7,62

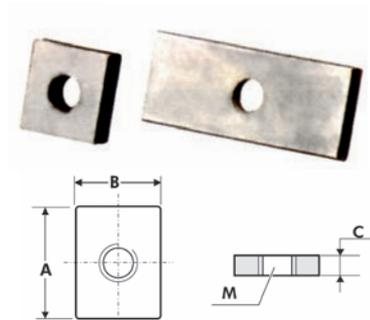

TUERCAS CUADRADAS Y RECTANGULARES						
CÓDIGO	ENVASE EMBALAJE	DESCRIPCIÓN	€/envase			
			A	B	C	
270802	100	Envase 100 tuercas cuadradas M5	19	16	3	31,95
270803	100	Envase 100 tuercas cuadradas M6	18	16	3	34,46
270804	100	Envase 100 tuercas rectangulares M6	36	16	3	39,98
270805	100	Envase 100 tuercas rectangulares M8	36	20	4	91,71

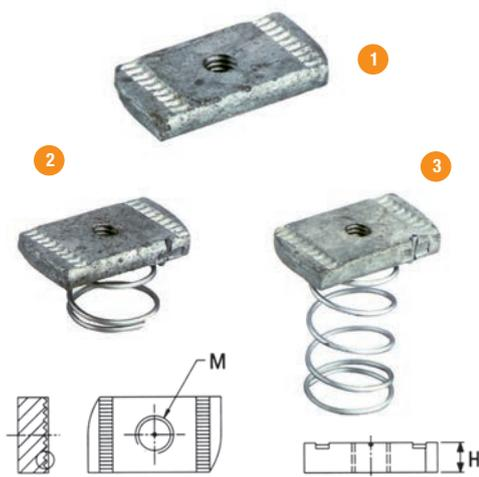

TUERCAS REFORZADAS			
CÓDIGO	ENVASE EMBALAJE	DESCRIPCIÓN	€/ud
270901	100	Tuerca reforzada M6	3,01
270902	100	Tuerca reforzada M8	(1) 3,09
270903	100	Tuerca reforzada M10	3,22
270904	100	Tuerca reforzada muelle corto M6 H5	3,16
270905	100	Tuerca reforzada muelle corto M8 H6	(2) 3,32
270906	100	Tuerca reforzada muelle corto M10 H8	3,62
270907	100	Tuerca reforzada muelle largo M6 H5	3,21
270908	100	Tuerca reforzada muelle largo M8 H6	(3) 3,32
270909	100	Tuerca reforzada muelle largo M10 H8	3,40

Consultar embalajes para el suministro de placas enteras

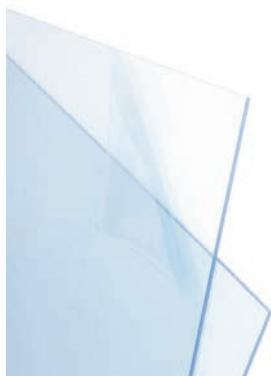

PLACAS DE POLICARBONATO TRANSPARENTE U.V.

CÓDIGO	ENVASE EMBALAJE	DESCRIPCIÓN	€/ud
180251	1	Placa Policarbonato 2050x1525x2 mm	552,98
180252	1	Placa Policarbonato 2050x1525x3 mm	761,44
180253	1	Placa Policarbonato 2050x1525x4 mm	866,77
180254	1	Placa Policarbonato 2050x1525x5 mm	1080,75



PLACAS DE POLIÉSTER

CÓDIGO	ENVASE EMBALAJE	DESCRIPCIÓN	€/ud
180102	1	Placa de poliester 1250x1020x3 mm	134,60
180103	1	Placa de poliester 1250x1020x4 mm	177,42
180104	1	Placa de poliester 1250x1020x5 mm	225,44
180105	1	Placa de poliester 1250x1020x6 mm	250,94



PLACAS DE BAQUELITA ANTI-TRACKING

CÓDIGO	ENVASE EMBALAJE	DESCRIPCIÓN	€/ud
180173	1	Placa baq. reforz. 1300x930x3 mm gris	178,10
180174	1	Placa baq. reforz. 1300x930x4 mm gris	233,54
180175	1	Placa baq. reforz. 1300x930x5 mm gris	292,80
180176	1	Placa baq. reforz. 1300x930x6 mm gris	355,72
180178	1	Placa baq. reforz. 1300x930x8 mm gris	468,66
180180	1	Placa baq. reforz. 1300x930x10 mm gris	592,60

Otros formatos, consultar.

Placa de baquelita con laminado exterior de fenol/melanina que ofrece altas prestaciones mecánicas y eléctricas además de una resistencia adecuada al arco.

Recomendado su uso como placas de montaje en cuadros, separadores de polos en interruptores de hasta 36KV de voltaje nominal y para instalaciones de telefonía, barcos, plantas industriales y centrales eléctricas.

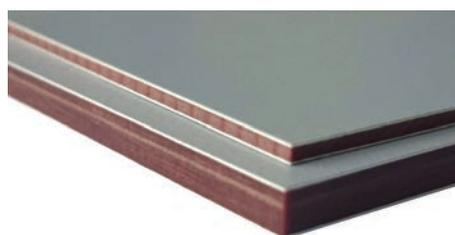

Se realiza cualquier mecanización bajo demanda y según cantidades.

Se puede mecanizar con el mismo tipo de herramientas y maquinaria que se usa en la industria de la madera.

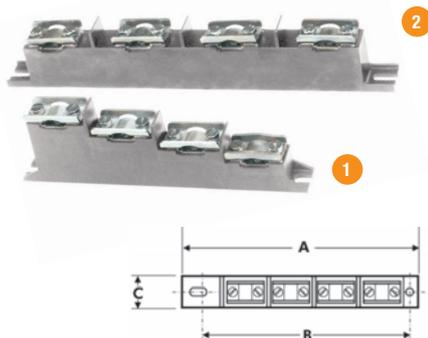

SOPORTES DE EMBARRADO

CÓDIGO	ENVASE EMBALAJE	DESCRIPCIÓN	DIMENSIONES (mm)			€/ud	
			A	B	C		
310301	20	Soporte de escalera	217	199	23	(1)	13,09
310302	20	Soporte plano	305	288	23	(2)	14,92



SOPORTES PLANOS DE EMBARRADO 160-630 A.

CÓDIGO	ENVASE EMBALAJE	DESCRIPCIÓN	€/ud
310310	4	Soporte embarrado 60T-3F	(1) 62,12
310311	2	Tapa final 60T	(3) 18,46
310312	4	Soporte embarrado 60TN-4F	(2) 81,51
310313	2	Tapa final 60TN	(3) 25,35

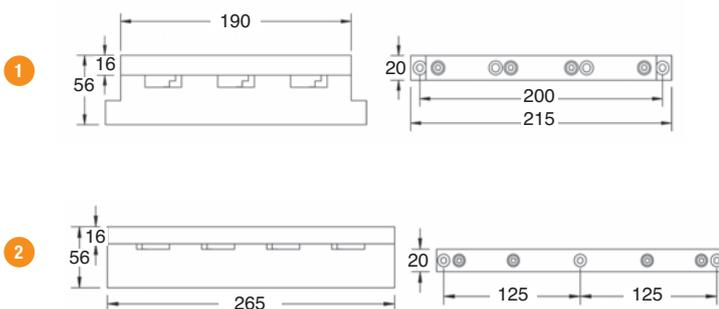

- Para barras espesor 5 y 10 mm.
- Anchos de barra de 15, 20, 25 y 30 mm.
- Tapa final para proteger el extremo de las barras



SOPORTE PLANO DE EMBARRADO 630-1200 A.

CÓDIGO	ENVASE EMBALAJE	DESCRIPCIÓN	€/ud
310314	4	Soporte embarrado 100T-3F	(1) 156,20
310315	10	Tapa final 100T	(2) 19,36
310316	24	Clip 40x10	(3) 2,53
310317	24	Clip 50x10	(3) 2,53

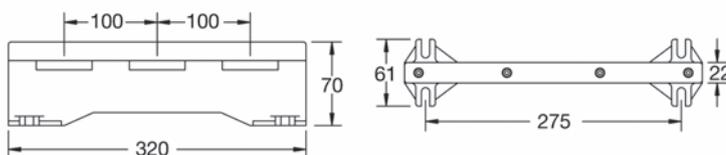

- Para barras espesor 10 mm.
- Soporte muy versátil, para barras 60 mm. de ancho y usando los clips para 40 y 50 mm.
- Tapa final para proteger el extremo de las barras



Fabricación a medida de las placas de protección según la longitud del embarrado

SOPORTES ESCALERA 125-400 A.

CÓDIGO	ENVASE EMBALAJE	DESCRIPCIÓN	€/ud
310321	10	Soporte escalera 125-160 A. 1000 V. (1)	19,74
310322	10	Soporte escalera 125-160 A. 630 V. (2)	23,95
310323	10	Soporte escalera 250 A. 630 V. (3)	20,72
310324	2	Soporte escalera 400 A. 1000 V. (4)	65,64

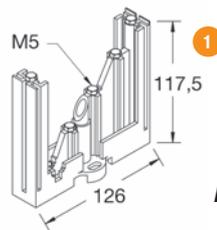

**Pletinas 12x4
15x5**

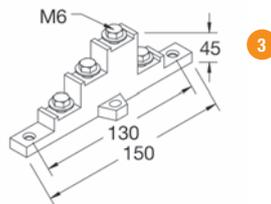
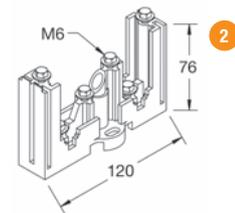

**Pletinas 15x5
20x5**

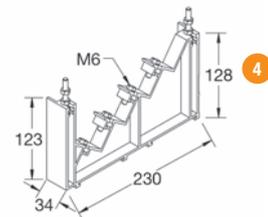

**Pletinas 15x5
20x5
30x5
20x10
30x10**

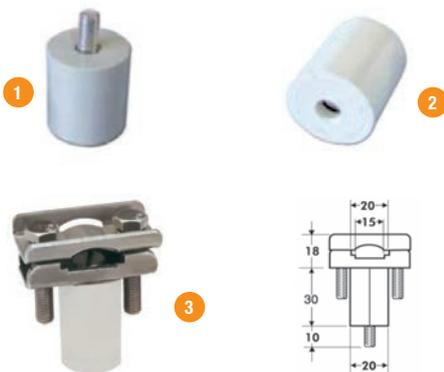

AISLADORES

CÓDIGO	ENVASE EMBALAJE	DESCRIPCIÓN	€/ud
310501	50	Aislador ATE-30 ECO tuerca-espárrago (1)	2,25
310505	50	Aislador ATE-30 ECO tuerca-espárrago INOX (1)	3,92
310502	50	Aislador ATT-30 ECO tuerca-tuerca	2,25
310503	50	Aislador AN-30 nylon pasante M6 (2)	1,60
310504	20	Aislador ABE-30 (3)	4,30

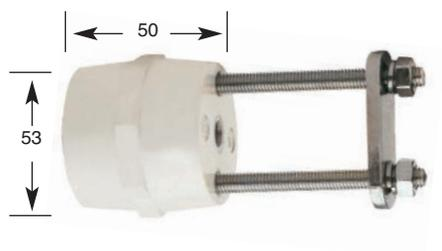
**AISLADOR Y PORTABARRAS**

CÓDIGO	ENVASE EMBALAJE	DESCRIPCIÓN	€/ud
310711	20	Aislador ALP-50/10+ 2x8	11,97
310902	10	Portabarras JP 40	7,56
310903	10	Portabarras JP 60	7,92
310904	10	Portabarras JP 80	8,47

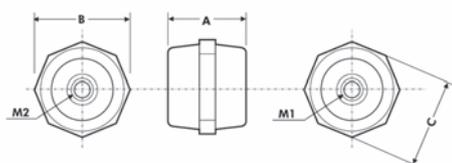
**AISLADORES POLIÉSTER LINEA P**

CÓDIGO	ENVASE EMBALAJE	DESCRIPCIÓN	DIMENSIONES (mm)					€/ud
			A	B	C	M1	M2	
310701	20	Aislador ALP-25/6	25	30	26	6	6	3,80
310702	20	Aislador ALP-30/8	30	34	32	8	8	4,39
310703	10	Aislador ALP-35/8	35	34	32	8	8	5,27
310704	10	Aislador ALP-40/8	40	42	40	8	8	6,60
310705	10	Aislador ALP-40/10	40	42	40	10	10	7,93
310706	10	Aislador ALP-45/8	45	38	36	8	8	8,66
310708	10	Aislador ALP-50/10	50	39	36	10	10	9,99
310713	10	Aislador ALP-60/10	60	50	47	10	10	15,44
310717	10	Aislador ALP-75/10	75	54	50	10	10	20,23

Datos técnicos página 140

AISLADORES LIBRES DE HALÓGENOS LINEA N

CÓDIGO	ENVASE EMBALAJE	DESCRIPCIÓN	DIMENSIONES (mm)					€/ud
			A	B	C	M1	M2	
310800	50	Aislador ALH-20/6	20	20	17	6	6	3,93
310801	50	Aislador ALH-25/6	25	20	19	6	6	4,24
310802	25	Aislador ALH-30/6	30	34	30	6	6	6,04
310803	10	Aislador ALH-35/6	35	46	41	6	6	6,70
310804	10	Aislador ALH-40/6	40	53	46	6	6	9,03
310805	10	Aislador ALH-45/6	45	47	41	6	6	10,62
310811	10	Aislador ALH-30/8	30	34	30	8	8	6,04
310812	10	Aislador ALH-35/8	35	46	41	8	8	7,87
310813	10	Aislador ALH-40/8	40	53	46	8	8	9,48
310814	10	Aislador ALH-45/8	45	47	41	8	8	10,06
310821	10	Aislador ALH-35/10	35	46	41	10	10	8,30
310822	10	Aislador ALH-40/10	40	53	46	10	10	9,64
310823	5	Aislador ALH-45/10	45	57	50	10	10	10,25
310824	5	Aislador ALH-50/10	50	57	50	10	10	12,76
310825	4	Aislador ALH-60/10	60	63	55	10	10	16,84
310831	4	Aislador ALH-60/12	60	63	55	12	12	17,16
310832	5	Aislador ALH-70/12	70	75	65	12	12	26,26

Datos técnicos página 140

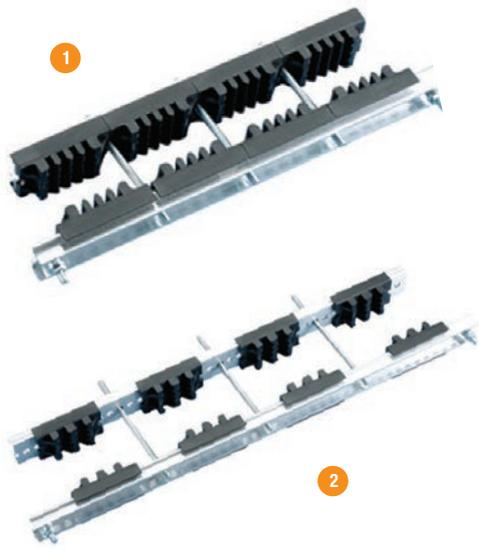

1

2

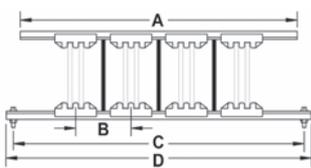

- Sistema universal de fijación
- Distancia entre fases ajustables (paso de 12,5 mm.)
- Premontado o a medida
- Libre de halógenos

JUEGO SOPORTE COMPACTO AJUSTABLE DE BARRAS

CÓDIGO	ENVASE EMBALAJE	DESCRIPCIÓN		€/ud
310405	1	Juego sop. compacto SCAB 4/5 TN 400	(1)	85,54
310406	1	Juego sop. compacto SCAB 2/10 TN 400	(2)	107,87
310407	1	Juego sop. compacto SCAB 4/5 TN 600	(1)	105,98
310408	1	Juego sop. compacto SCAB 2/10 TN 600	(2)	135,63

• Fondo armario de 300 a 800 mm. • de 400 a 4000 Amp.

Nº. BARRAS	Medidas BARRAS	A	B	C	D	
310405	1 - 4	30 a 125 x 5	300	75	325	350
310406	1 - 2	30 a 120 x 10	300	75	325	350
310407	1 - 4	30 a 125 x 5	500	75 a 125	525	550
310408	1 - 2	30 a 120 x 10	500	75 a 125	525	550

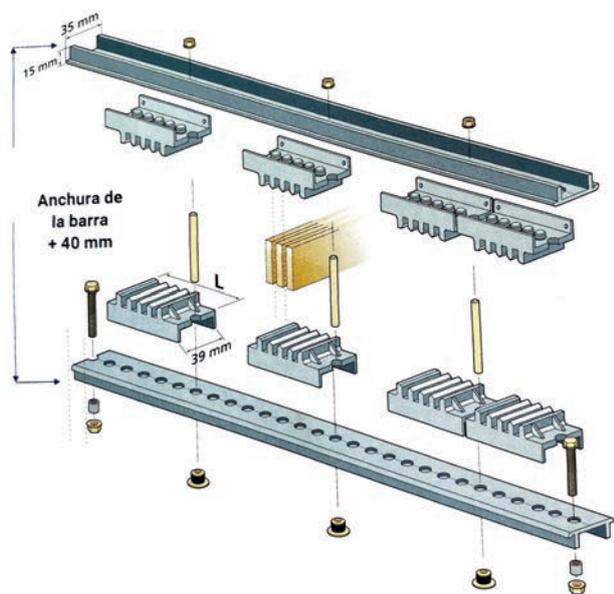

SOPORTE COMPACTO DE BARRAS AJUSTABLE

CÓDIGO	ENVASE EMBALAJE	DESCRIPCIÓN		€/ud
310411	1	Perfil aluminio SCAB 2000 mm.		71,53
310415	1	Conjunto aisladores SCAB 4/5 T	(1)	48,63
310416	1	Conjunto aisladores SCAB 2/10 T		48,63
310417	1	Conjunto aisladores SCAB 3/10 T		66,35
310421	1	Conjunto aisladores SCAB 4/5 TN	(2)	55,71
310422	1	Conjunto aisladores SCAB 2/10 TN		62,14
310423	1	Conjunto aisladores SCAB 3/10 TN		84,24

Nº. BARRAS	Medidas BARRAS
------------	----------------

- 1 T= 3 Fases.
- 2 TN= 3 Fases+Neutro.

310415-21	1 - 4	30 a 125 x 5
310416-22	1 - 2	30 a 120 x 10
310417-23	1 - 3	30 a 120 x 10



- *Distancia entre fases ajustables*
- *Alta resistencia a la fuerza de cortocircuito*
- *Libre de halógenos*

SOPORTE DE BARRAS HORIZONTALES AJUSTABLES

CÓDIGO	ENVASE EMBALAJE	DESCRIPCIÓN		€/ud
310430	2	Perfil aluminio ALP 2000 mm.	(1)	219,91
310431	12	Aislador ALP-B	(2)	27,87

Para barras de 30 a 125 mm.
Intensidad: 2300 A.

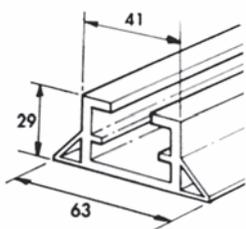

- *Deslizamiento y ajuste al espesor de la barra (5/10) simplemente girando el aislador*
- *Con 2 aisladores por barra se pueden ajustar la distancia entre fases*
- *UN aislador puede soportar 2 barras y la distancia entre ellas de 34 mm.*

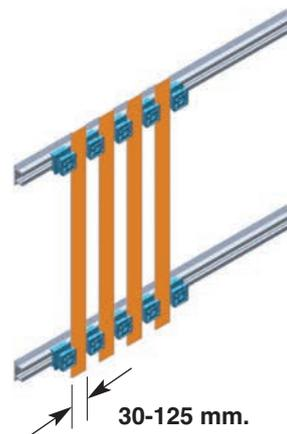
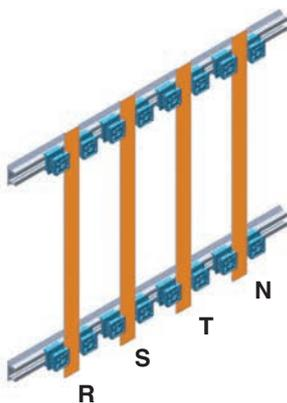
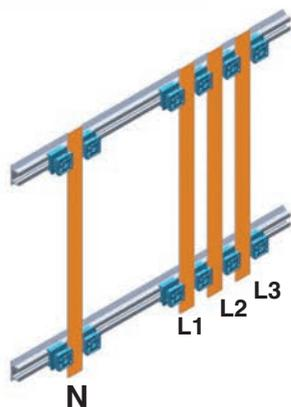
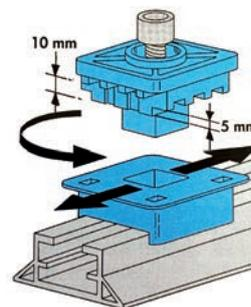

GEL AISLANTE Y SELLANTE

CÓDIGO	ENVASE EMBALAJE	DESCRIPCIÓN		€/ud
310201	1	Gel aislante 2x150 gr.		31,92
310202	1	Gel aislante 2x500 gr.		67,87

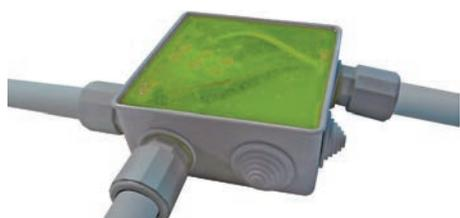

- *Baja viscosidad, atóxico, óptima transparencia.*
- *Rigidez dieléctrica 20 Kv/mm.*
- *Para instalaciones hasta 1 Kv.*
- *Genera grado de protección IP68.*
- *No caduca.*
- *No conservar por debajo de 4°C.*

Se suministra con jarra graduada y espátula



Libre de halógenos

Datos técnicos página 141



FUNDA POLIOLEFINA TERMO-ADAPTABLE EN ROLLO

CÓDIGO	ENVASE EMBALAJE	DESCRIPCIÓN	DIMENSIONES (mm)		€/m
			A	B	
100602	20	Mts. funda poliolefina FPT-1,2 negra	1,2	0,6	3,23
100612	20	Mts. funda poliolefina FPT-1,6 negra	1,6	0,8	3,44
100622	15	Mts. funda poliolefina FPT-2,4 negra	2,4	1,2	3,63
100631	15	Mts. funda poliolefina FPT-3,2 azul	3,2	1,6	3,74
100632	15	Mts. funda poliolefina FPT-3,2 negra	3,2	1,6	3,74
100633	15	Mts. funda poliolefina FPT-3,2 gris	3,2	1,6	3,74
100634	15	Mts. funda poliolefina FPT-3,2 marrón	3,2	1,6	3,74
100635	15	Mts. funda poliolefina FPT-3,2 a/v	3,2	1,6	6,52
100641	12	Mts. funda poliolefina FPT-4,8 azul	4,8	2,4	4,93
100642	12	Mts. funda poliolefina FPT-4,8 negra	4,8	2,4	4,93
100643	12	Mts. funda poliolefina FPT-4,8 gris	4,8	2,4	4,93
100644	12	Mts. funda poliolefina FPT-4,8 marrón	4,8	2,4	4,93
100645	12	Mts. funda poliolefina FPT-4,8 a/v	4,8	2,4	9,63
100651	12	Mts. funda poliolefina FPT-6,4 azul	6,4	3,2	5,10
100652	12	Mts. funda poliolefina FPT-6,4 negra	6,4	3,2	5,10
100653	12	Mts. funda poliolefina FPT-6,4 gris	6,4	3,2	5,10
100654	12	Mts. funda poliolefina FPT-6,4 marrón	6,4	3,2	5,10
100655	12	Mts. funda poliolefina FPT-6,4 a/v	6,4	3,2	9,81
100661	10	Mts. funda poliolefina FPT-9,5 azul	9,5	4,8	5,21
100662	10	Mts. funda poliolefina FPT-9,5 negra	9,5	4,8	5,21
100663	10	Mts. funda poliolefina FPT-9,5 gris	9,5	4,8	5,21
100664	10	Mts. funda poliolefina FPT-9,5 marrón	9,5	4,8	5,21
100665	10	Mts. funda poliolefina FPT-9,5 a/v	9,5	4,8	10,03
100671	10	Mts. funda poliolefina FPT-12,7 azul	12,7	6,4	6,41
100672	10	Mts. funda poliolefina FPT-12,7 negra	12,7	6,4	6,41
100673	10	Mts. funda poliolefina FPT-12,7 gris	12,7	6,4	6,41
100674	10	Mts. funda poliolefina FPT-12,7 marrón	12,7	6,4	6,41
100675	10	Mts. funda poliolefina FPT-12,7 a/v	12,7	6,4	12,24
100681	6	Mts. funda poliolefina FPT-19 azul	19	9,5	7,25
100682	6	Mts. funda poliolefina FPT-19 negra	19	9,5	7,25
100683	6	Mts. funda poliolefina FPT-19 gris	19	9,5	7,25
100684	6	Mts. funda poliolefina FPT-19 marrón	19	9,5	7,25
100685	6	Mts. funda poliolefina FPT-19 a/v	19	9,5	13,94
100691	6	Mts. funda poliolefina FPT-25,4 azul	25,4	12,7	12,69
100692	6	Mts. funda poliolefina FPT-25,4 negra	25,4	12,7	12,69
100693	6	Mts. funda poliolefina FPT-25,4 gris	25,4	12,7	12,69
100694	6	Mts. funda poliolefina FPT-25,4 marrón	25,4	12,7	12,69
100695	6	Mts. funda poliolefina FPT-25,4 a/v	25,4	12,7	24,47

FUNDA POLIOLEFINA TERMO-ADAPTABLE EN BOBINA

CÓDIGO	ENVASE EMBALAJE	DESCRIPCIÓN	DIMENSIONES (mm)		€/m
			A	B	
100662-B	100	Mts. funda poliol. FPT-9,5 negra bobina	9,5	4,5	4,35
100672-B	100	Mts. funda poliol. FPT-12,7 negra bobina	13	6,5	5,62
100682-B	100	Mts. funda poliol. FPT-19 negra bobina	20	10	6,81
100692-B	50	Mts. funda poliol. FPT-25,4 negra bobina	25,4	12,7	12,32
100687-B	25	Mts. funda poliol. FPT-35 negra bobina	35	17,5	18,72
100688-B	25	Mts. funda poliol. FPT-40 negra bobina	40	20	23,91
100690-B	25	Mts. funda poliol. FPT-50 negra bobina	50	26	31,75

Se puede suministrar en colores bajo demanda.



TUBO TERMO-RETRÁCTIL 1000V. CON ADHESIVO

CÓDIGO	ENVASE EMBALAJE	DESCRIPCIÓN	€/ud
100711	10	Tubo 1000 V TAT-12/3	17,48
100712	10	Tubo 1000 V TAT-22/6	26,71
100713	10	Tubo 1000 V TAT-33/8	33,56
100714	10	Tubo 1000 V TAT-40/12	43,27
100715	10	Tubo 1000 V TAT-55/16	56,41
100716	5	Tubo 1000 V TAT-75/22	79,66

Datos técnicos página 141

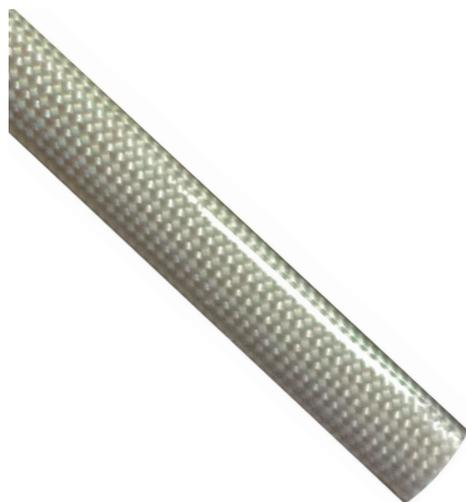

TUBO AISLANTE FIBRA DE VIDRIO - POLIURETANO

CÓDIGO	ENVASE EMBALAJE	DESCRIPCIÓN	€/m
311101	200	Mts. tubo aislante poliuretano FV-P 0,5mm.	0,70
311103	200	Mts. tubo aislante poliuretano FV-P 1mm.	0,78
311105	200	Mts. tubo aislante poliuretano FV-P 2mm.	0,94
311109	200	Mts. tubo aislante poliuretano FV-P 4mm.	1,56
311111	100	Mts. tubo aislante poliuretano FV-P 6mm.	2,08
311113	100	Mts. tubo aislante poliuretano FV-P 8mm.	2,90
311115	100	Mts. tubo aislante poliuretano FV-P 10mm.	6,88
311117	100	Mts. tubo aislante poliuretano FV-P 12mm.	8,54
311119	50	Mts. tubo aislante poliuretano FV-P 14mm.	10,75
311121	50	Mts. tubo aislante poliuretano FV-P 16mm.	12,03
311122	50	Mts. tubo aislante poliuretano FV-P 18mm.	15,34
311123	50	Mts. tubo aislante poliuretano FV-P 20mm.	16,64
311124	30	Mts. tubo aislante poliuretano FV-P 22mm.	21,35
311126	30	Mts. tubo aislante poliuretano FV-P 25mm.	28,16
311127	30	Mts. tubo aislante poliuretano FV-P 30mm.	36,93
311128	30	Mts. tubo aislante poliuretano FV-P 35mm.	54,67
311129	30	Mts. tubo aislante poliuretano FV-P 40mm.	67,42

Otras medidas consultar

Datos técnicos página 142



TUBO AISLANTE FIBRA DE VIDRIO - SILICONA

CÓDIGO	ENVASE EMBALAJE	DESCRIPCIÓN	€/m
311151	200	Mts. tubo aislante silicona FV-S 0,5mm.	0,60
311153	200	Mts. tubo aislante silicona FV-S 1mm.	0,76
311155	200	Mts. tubo aislante silicona FV-S 2mm.	0,93
311159	200	Mts. tubo aislante silicona FV-S 4mm.	1,60
311161	100	Mts. tubo aislante silicona FV-S 6mm.	2,18
311163	100	Mts. tubo aislante silicona FV-S 8mm.	3,10
311165	100	Mts. tubo aislante silicona FV-S 10mm.	7,03
311167	100	Mts. tubo aislante silicona FV-S 12mm.	9,06
311169	50	Mts. tubo aislante silicona FV-S 14mm.	11,86
311171	50	Mts. tubo aislante silicona FV-S 16mm.	14,00
311172	50	Mts. tubo aislante silicona FV-S 18mm.	17,36
311173	50	Mts. tubo aislante silicona FV-S 20mm.	18,85
311174	30	Mts. tubo aislante silicona FV-S 22mm.	23,65
311176	30	Mts. tubo aislante silicona FV-S 25mm.	32,07
311177	30	Mts. tubo aislante silicona FV-S 30mm.	43,10
311178	30	Mts. tubo aislante silicona FV-S 35mm.	64,32
311179	30	Mts. tubo aislante silicona FV-S 40mm.	80,28
311180	30	Mts. tubo aislante silicona FV-S 45mm.	99,72

Otras medidas consultar

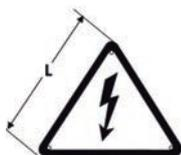

SEÑALES ELÉCTRICAS

CÓDIGO	ENVASE EMBALAJE	DESCRIPCIÓN		€/ud
290101-R	1000	Triáng. adh. rollo TAD- 52	L 52 mm	0,36
290103-R	1000	Triáng. adh. rollo TAD-52 T.T. neutro	L 52 mm	0,36
290104-R	1000	Triáng. adh. rollo TAD-52 T.T. herrajes	L 52 mm	0,36
290101	25	Triángulo adhesivo TAD- 52	L 52 mm	1,47
290108	25	Triángulo adhesivo tierra TADT-52	L 52 mm	1,47
290102	25	Triángulo adhesivo TAD-105	L 105 mm	2,04
290105	25	Triángulo rígido aluminio TR-105	L 105 mm	4,42
290106	25	Triángulo rígido aluminio TR-148	L 148 mm	8,85
290107	25	Triángulo rígido aluminio TR-210	L 210 mm	12,05

• Los triángulos TAD-52 en rollo se suministran en su envase de 1000 uds.

• Los triángulos adhesivos se suministran en bolsas de 25 uds.

SEÑALES ELÉCTRICAS ALTA TENSION

CÓDIGO	ENVASE EMBALAJE	DESCRIPCIÓN	DIMENSIONES (mm)			€/ud
			A	B	L	
290111	25	Triángulo rígido AL TRA-148	52	148	148	12,80
290112	25	Triángulo rígido AL TRA-210	71	210	210	16,98
290113	25	Triángulo policarb. TRP-148	52	148	148	13,02
290114	25	Triángulo policarb. TRP-210	71	210	210	24,48



1

SEÑALES INFORMATIVAS

CÓDIGO	ENVASE EMBALAJE	DESCRIPCIÓN		€/ud
290204	1	Placa primeros auxilios Flexible	(1)	15,50
290202	1	Placa requisitos previos	(2)	16,84
290203	1	Placa cinco reglas oro	(3)	17,25



3



2



CINTA ATENCIÓN CABLES ELÉCTRICOS

CÓDIGO	ENVASE EMBALAJE	DESCRIPCIÓN	€/envase
290301	500/1000	Envase 500 Mts. C.A.C.N. neutra	133,10
290302	500/1000	Envase 500 Mts. C.A.C.I. Iberdrola	145,20
290303	500/1000	Envase 500 Mts. C.A.C.U. Unión Fenosa	145,20

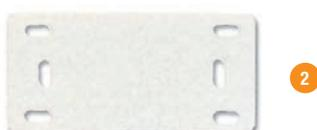
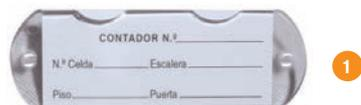

ETIQUETA CENTRALIZACIÓN Y HAZ DE CABLE

CÓDIGO	ENVASE EMBALAJE	DESCRIPCIÓN	€/envase
290401	200	Envase 200 etiquetas policarbonato	(1) 119,36
290411	100	Envase 100 etiquetas neutras haz de cables	(2) 16,84

SEÑALIZADORES Y ROTULADOR

CÓDIGO	ENVASE EMBALAJE	DESCRIPCIÓN	€/envase
290419	1000	Envases 1000 señal. de 2,5 a 5,0 mm. neutro	22,52
290420	1000	Envases 1000 señal. de 2,5 a 5,0 mm. "0"	22,52
290421	1000	Envases 1000 señal. de 2,5 a 5,0 mm. "1"	22,52
290422	1000	Envases 1000 señal. de 2,5 a 5,0 mm. "2"	22,52
290423	1000	Envases 1000 señal. de 2,5 a 5,0 mm. "3"	22,52
290424	1000	Envases 1000 señal. de 2,5 a 5,0 mm. "4"	22,52
290425	1000	Envases 1000 señal. de 2,5 a 5,0 mm. "5"	22,52
290426	1000	Envases 1000 señal. de 2,5 a 5,0 mm. "6"	22,52
290427	1000	Envases 1000 señal. de 2,5 a 5,0 mm. "7"	22,52
290428	1000	Envases 1000 señal. de 2,5 a 5,0 mm. "8"	22,52
290429	1000	Envases 1000 señal. de 2,5 a 5,0 mm. "9"	22,52
290439	500	Envases 500 señal. de 4,0 a 10,0 mm. neutro	22,52
290440	500	Envases 500 señal. de 4,0 a 10,0 mm. "0"	22,52
290441	500	Envases 500 señal. de 4,0 a 10,0 mm. "1"	22,52
290442	500	Envases 500 señal. de 4,0 a 10,0 mm. "2"	22,52
290443	500	Envases 500 señal. de 4,0 a 10,0 mm. "3"	22,52
290444	500	Envases 500 señal. de 4,0 a 10,0 mm. "4"	22,52
290445	500	Envases 500 señal. de 4,0 a 10,0 mm. "5"	22,52
290446	500	Envases 500 señal. de 4,0 a 10,0 mm. "6"	22,52
290447	500	Envases 500 señal. de 4,0 a 10,0 mm. "7"	22,52
290448	500	Envases 500 señal. de 4,0 a 10,0 mm. "8"	22,52
290449	500	Envases 500 señal. de 4,0 a 10,0 mm. "9"	22,52
290415	1	Rotulador permanente	9,99





Tornillo Insertado

Bajo demanda se suministran montajes tripolares

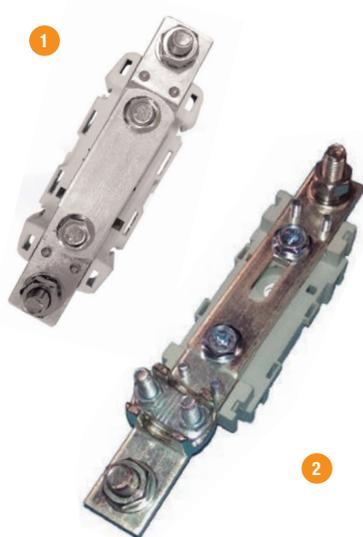

PORTAFUSIBLES NH

CÓDIGO	ENVASE EMBALAJE	DESCRIPCIÓN	€/ud
--------	-----------------	-------------	------

"NH" unipolar contacto escuadra

320101	3	Portafusible PNH-00 100/160	7,53
320102	3	Portafusible PNH-0 160	11,27
320103	3	Portafusible PNH-1 250	18,50
320104	3	Portafusible PNH-2 400	24,60

"NH" unipolar contacto lira

320106	3	Portafusible PNHL-1 250	21,48
320107	3	Portafusible PNHL-2 400	27,61
320108	3	Portafusible PNHL-3 630	47,63
320109	1	Portafusible PNHL-4 1250	198,53

"NH" unipolar tornillos insertados INOX

320111	3	Portafusible PNHINOX-00 100/160	10,30
320112	3	Portafusible PNHINOX-0 160	13,31
320114	3	Portafusible PNHINOX-1 lira 250	24,85
320115	3	Portafusible PNHINOX-2 lira 400	30,62
320116	3	Portafusible PNHINOX-3 lira 630	50,78

NEUTROS RÍGIDOS

CÓDIGO	ENVASE EMBALAJE	DESCRIPCIÓN	€/ud
--------	-----------------	-------------	------

320141	3	NR-00 100-T	(1) 8,51
320144	3	NR-0 160-T	(1) 12,41
320145	3	NR-250/400-T	(1) 18,11
320146	3	NR-630-T	(1) 22,52

Neutros con tornillos insertados INOX

320161	3	NRI-00 100-TI	(1) 12,70
320162	3	NRI-0 160-TI	(1) 16,94
320163	3	NRI-250/400-TI	(1) 26,79
320164	3	NRI-630-TI	(1) 35,36

Neutros con tornillos insertados INOX y Borne Bimetálico

320166	15	NRI-00 100-TI con borne 50mm	(2) 14,62
320167	10	NRI-0 160-TI con borne 50mm	19,43
320168	15	NRI-1/2 250/400-TI con borne 50mm.	27,17

BARRAS DE NEUTRO

CÓDIGO	ENVASE EMBALAJE	DESCRIPCIÓN	€/ud
--------	-----------------	-------------	------

320181	10	Cuchilla CS-00	8,04
320182	10	Cuchilla CS-0	9,12
320183	10	Cuchilla CS-1	10,08
320184	10	Cuchilla CS-2	13,21
320185	10	Cuchilla CS-3	16,88
320186	1	Cuchilla CS-4	80,56

MANETA EXTRACTORA

CÓDIGO	ENVASE EMBALAJE	DESCRIPCIÓN	€/ud
--------	-----------------	-------------	------

320191	1/10	Maneta extractora ME	30,14
--------	------	----------------------	-------

SEPARADORES NH AISLANTES

CÓDIGO	ENVASE EMBALAJE	DESCRIPCIÓN	€/ud
320171	10	Separadora S-00	3,24
320172	10	Separadora S-0	4,55
320174	10	Separadora S-1/2	6,77
320176	10	Separadora S-3	9,04
320178	10	Separadora S-4	13,59

BASES • TAPONES • TAPAS • FUSIBLES NEOZED

CÓDIGO	ENVASE EMBALAJE	DESCRIPCIÓN	€/ud
320506	10	Base BDO-2-T para panel	6,77
320501	20	Base BDO-2-P para pletina	5,57
320502	10	Base BDO-2-PR para carril	6,71
320503	5	Base BDO-3-P para pletina	17,79
320504	10	Base BDO-3-PR para carril	18,81

TAPONES

320512	20	Tapón TDO-2-CR	2,95
320514	10	Tapón TDO-3-CR	17,91

TAPAS

320521	10	Tapa TE-63	0,94
320522	5	Tapa TE-100	4,72

FUSIBLES

320608	10	Fusible FN-2-35 A.	1,94
320609	10	Fusible FN-2-50 A.	2,27
320610	10	Fusible FN-2-63 A.	2,41
320611	20	Fusible FN-3-80 A.	13,98
320612	20	Fusible FN-3-100 A.	13,98

BASES BUC

CÓDIGO	ENVASE EMBALAJE	DESCRIPCIÓN	€/ud
322202	1/30	Base BUC NCH-00 TO M8 A2 ILF	26,27
322203	8	Base BUC NCH-1 Estandar 250 M10 INOX ILF	68,68
322204	1	Base BUC NCH-2 Estandar 400 M10 INOX ILF	69,13
322206	1	Base BUC NCH-1 LL M10 A2 ILF	74,52
322207	1	Base BUC NCH-2 LL M10 A2 ILF	75,17
322205	1	Base BUC NCH-3 LL M10 A2 ILF	266,00

PROTECTORES BUC

CÓDIGO	ENVASE EMBALAJE	DESCRIPCIÓN	€/ud
201181	1/52	Tapa bipolar BUC	13,79
201182	1/26	Tapa tetrapolar BUC	18,84





BASES UTE

CÓDIGO	ENVASE EMBALAJE	DESCRIPCIÓN		€/ud
320323	12	Base BSP-1x32 A. para carril DIN	(1)	7,25
320301	5	Base BSU-50 14x51	(2)	9,10
320302	5	Base BSU-100 22x58	(2)	11,72
320303	1	Base BSU 3x100 + N	(3)	54,50
320402	10	Cilindro CN-100	(4)	2,36



BASE Y FUSIBLE FOTOVOLTÁICAS

CÓDIGO	ENVASE EMBALAJE	DESCRIPCIÓN		€/ud
320426	12	Base UTE 1x32 A. 1000 V.	(1)	9,50
320416	10	Fusible UTE 10x38 1000 VDC 16 A.	(5)	6,01



OBTURADOR HUECOS

CÓDIGO	ENVASE EMBALAJE	DESCRIPCIÓN		€/ud
320703	4	Obturador huecos magnetotérmico (1m)		9,23





CAJAS ALUMBRADO IP-13 INTERIOR

CÓDIGO	ENVASE EMBALAJE	DESCRIPCIÓN	€/ud
322101	1	Caja alumb. CAL-IP13 4E16mm/2S 150x60x65	(1) 19,83
322102	1	Caja alumb. CAL-IP13 2E16mm/1S 150x60x65	- 20,80
322104	1	Caja alumb. CAL-IP13 4E25mm/2S 148x83x65	(1) 23,99
322105	1	Caja alumb. CAL-IP13 4E35mm/2S 165x120x70	(1) 33,32
322106	1	Caja alumb. CAL-IP13 6E35mm/2S 165x120x70	(3) 43,71
322107	1	Caja alumb. CAL-IP13 4E35mm/4S 165x120x70	(4) 38,97
322108	1	Caja alumb. CAL-IP13 5E16mm/2S 150x60x65	(2) 23,23
322109	1	Caja alumb. CAL-IP13 5E25mm/2S 148x83x65	(2) 27,63
322110	1	Caja alumb. CAL-IP13 5E35mm/2S 165x120x70	(2) 36,35
322111	1	Caja alumb. CAL-IP13 5E35mm/4S 165x120x70	(5) 43,96
322112	1	Caja alumb. CAL-IP13 6E35mm/4S 165x120x70	(6-7) 46,91



CAJAS ALUMBRADO IP-44 EXTERIOR

CÓDIGO	ENVASE EMBALAJE	DESCRIPCIÓN	€/ud
322121	1	Caja alumb. CAL-IP44 4E16mm/2S 150x60x65	(1) 19,83
322122	1	Caja alumb. CAL-IP44 5E16mm/2S 150x60x65	(2) 24,53
322123	1	Caja alumb. CAL-IP44 4E25mm/2S 148x83x65	(1) 25,78
322124	1	Caja alumb. CAL-IP44 5E25mm/2S 148x83x65	(2) 28,57
322125	1	Caja alumb. CAL-IP44 4E35mm/2S 165x120x70	(1) 39,66
322126	1	Caja alumb. CAL-IP44 6E35mm/2S 165x120x70	(3) 43,72
322127	1	Caja alumb. CAL-IP44 4E35mm/4S 165x120x70	(4) 46,71
322128	1	Caja alumb. CAL-IP44 5E35mm/2S 165x120x70	(2) 41,41
322129	1	Caja alumb. CAL-IP44 5E35mm/4S 165x120x70	(5) 48,21
322130	1	Caja alumb. CAL-IP44 6E35mm/4S 165x120x70	(6-7) 52,29

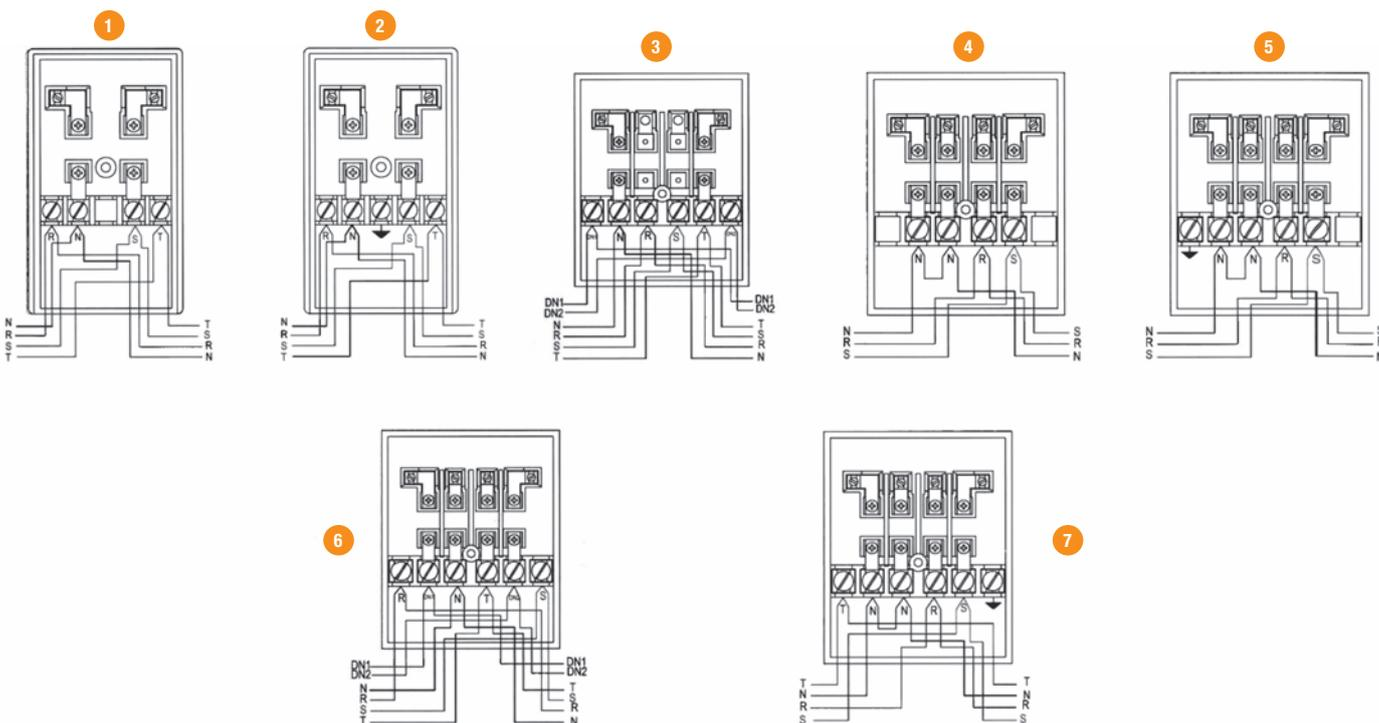



Cotas H y D
"Consultar"

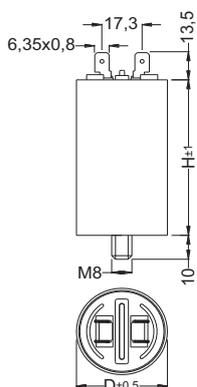

CONDENSADORES FASTON

CÓDIGO	EMBALAJE	DESCRIPCIÓN	€/ud
015036	1	Cond. AM RPN2-2µF 400Vac faston	4,45
015039	1	Cond. AM RPN2-3,15µF 400Vac faston	4,53
015041	1	Cond. AM RPN2-4µF 400Vac faston	4,55
015043	1	Cond. AM RPN2-6µF 400Vac faston	4,92
015045	1	Cond. AM RPN2-8µF 400Vac faston	5,16
015047	1	Cond. AM RPN2-10µF 400Vac faston	5,54
015049	1	Cond. AM RPN2-12µF 400Vac faston	5,78
015051	1	Cond. AM RPN2-14µF 400Vac faston	6,10
015052	1	Cond. AM RPN2-15µF 400Vac faston	6,23
015053	1	Cond. AM RPN2-16µF 400Vac faston	6,39
015054	1	Cond. AM RPN2-18µF 400Vac faston	6,93
015055	1	Cond. AM RPN2-20µF 400Vac faston	7,32
015056	1	Cond. AM RPN2-25µF 400Vac faston	8,69
015057	1	Cond. AM RPN2-30µF 400Vac faston	9,70
015059	1	Cond. AM RPN2-35µF 400Vac faston	11,38
015060	1	Cond. AM RPN2-40µF 400Vac faston	12,24
015061	1	Cond. AM RPN2-45µF 400Vac faston	13,84
015062	1	Cond. AM RPN2-50µF 400Vac faston	14,82
015063	1	Cond. AM RPN2-55µF 400Vac faston	15,31
015064	1	Cond. AM RPN2-60µF 400Vac faston	16,77
015066	1	Cond. AM RPN2-70µF 400Vac faston	18,39
015067	1	Cond. AM RPN2-75µF 400Vac faston	18,93
015068	1	Cond. AM RPN2-80µF 400Vac faston	21,39
015069	1	Cond. AM RPN2-90µF 400Vac faston	22,23
015070	1	Cond. AM RPN2-100µF 400Vac faston	25,48



Cotas H y D
"Consultar"

CONDENSADORES CON KIT MANGUERA

CÓDIGO	EMBALAJE	DESCRIPCIÓN	€/ud
015001	1	Cond. AM RPC2-2µF 400Vac manguera	4,45
015004	1	Cond. AM RPC2-3,15µF 400Vac manguera	4,53
015006	1	Cond. AM RPC2-4µF 400Vac manguera	4,55
015008	1	Cond. AM RPC2-6µF 400Vac manguera	4,92
015010	1	Cond. AM RPC2-8µF 400Vac manguera	5,16
015012	1	Cond. AM RPC2-10µF 400Vac manguera	5,54
015014	1	Cond. AM RPC2-12µF 400Vac manguera	5,78
015016	1	Cond. AM RPC2-14µF 400Vac manguera	6,10
015017	1	Cond. AM RPC2-15µF 400Vac manguera	6,23
015018	1	Cond. AM RPC2-16µF 400Vac manguera	6,39
015019	1	Cond. AM RPC2-18µF 400Vac manguera	6,93
015020	1	Cond. AM RPC2-20µF 400Vac manguera	7,32
015021	1	Cond. AM RPC2-25µF 400Vac manguera	8,69
015022	1	Cond. AM RPC2-30µF 400Vac manguera	9,70
015024	1	Cond. AM RPC2-35µF 400Vac manguera	11,38
015025	1	Cond. AM RPC2-40µF 400Vac manguera	12,24
015026	1	Cond. AM RPC2-45µF 400Vac manguera	13,84
015027	1	Cond. AM RPC2-50µF 400Vac manguera	14,82
015028	1	Cond. AM RPC2-55µF 400Vac manguera	15,31
015029	1	Cond. AM RPC2-60µF 400Vac manguera	16,77
015031	1	Cond. AM RPC2-70µF 400Vac manguera	18,39
015032	1	Cond. AM RPC2-75µF 400Vac manguera	18,93
015033	1	Cond. AM RPC2-80µF 400Vac manguera	21,39
015034	1	Cond. AM RPC2-90µF 400Vac manguera	22,23
015035	1	Cond. AM RPC2-100µF 400Vac manguera	25,48



CAJAS METÁLICAS IP55

CÓDIGO	ENVASE EMBALAJE	DESCRIPCIÓN	€/ud
141031	1	Caja metálica conex. 85x85x49	19,87
141032	1	Caja metálica conex. 105x105x49	25,74
141033	1	Caja metálica conex. 155x105x61	37,66
141034	1	Caja metálica conex. 206x156x83	57,01
141035	1	Caja metálica conex. 256x206x93	94,99

Fabricadas en chapa de acero protegido exterior e interiormente con pintura poliéster Epoxi color Ral 7032 texturizado.

Fijación a pared mediante orificios obturados con tapones plásticos que aseguran la estanqueidad.



CAJAS ALUMINIO IP66

CÓDIGO	ENVASE EMBALAJE	DESCRIPCIÓN	DIMENSIONES EXT.	€/ud
141020	1	Caja alum. S1		18,61
141021	1	Caja alum. S2		26,80
141022	1	Caja alum. S3		31,61
141023	1	Caja alum. S3-HC		74,54
141024	1	Caja alum. S4		46,33
141025	1	Caja alum. S5		74,98
141026	1	Caja alum. S6		130,31
141027	1	Caja alum. S7		226,00

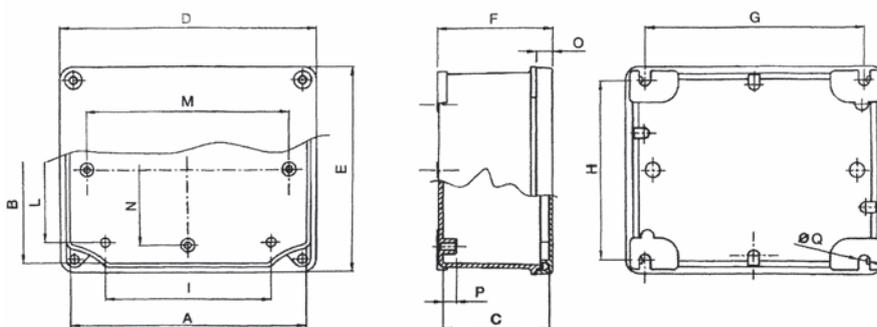

TIPO	dimensiones internas			dimensiones externas											
	A	B	C	D	E	F	G	H	I	L	M	N	O	P	Q
S1	91	91	53	101	101	58	88	80	52,5	42,5	-	-	8,3	7,5	6,1
S2	128	103	55	138,5	113,5	61,5	120	100	60	50	109	-	8,5	7,3	6,1
S3	154	129	58	165,5	140,5	63,5	144	125	104,5	102	135	110	8,6	7,2	6,1
S3-HC	154	129	130,8	165,5	140,5	136,8	144	125	104,5	102	135	110	81,9	7,2	6,1
S4	178	155	74	189	167	80	168	149	117	129,5	140	120	8,7	7,1	6,1
S5	239	202	85	252	215	91	226	196	178	164	208	168	9	8,7	8,7
S6	294	244	114	307	257	120,5	275	236	208	193,5	258	210	9,2	8,5	8,7
S7	392	298	149	406,5	312,5	156	367	283	290	237	320	230	14,8	8,5	8,7



BLOQUES DE CONTACTOS 10 Amp. 250V / 4Kv / 3

CÓDIGO	ENVASE EMBALAJE	DESCRIPCIÓN	€/ud
152001	1	Base 3 polos +TT-10A	(1) 4,32
152002	1	Base 4 polos +TT-10A	(1) 4,76
152003	1	Clavija 3 polos +TT-10A	(2) 4,03
152004	1	Clavija 4 polos +TT-10A	(2) 4,69

- Soporte aislante de policarbonato autoextinguible, homologado UL y CSA.
- Contactos de aleación de cobre plateados.
- Conexión con tornillo para cables de 0,5 - 2,5 mm² (AWG 20-14).
- Tornillos imperdibles par de torsión 0,5 Nm según norma EN 60999.



1

2

3



ZÓCALOS EMPOTRABLES 21x21

CÓDIGO	ENVASE EMBALAJE	DESCRIPCIÓN	€/ud
152005	1	Zócalo aisl. recto 10A	35x30x24,5 (1) 2,35
152006	1	Zócalo aisl. ángulo 10A	42x41,5x53,5 (2) 2,57
152007	1	Zócalo aisl. ángulo M20-10A	42x41,5x53,5 (3) 3,08
152008	1	Zócalo metal. recto 10A	35x30x24,5 (1) 5,12
152009	1	Zócalo metal. ángulo 10A	42x41,5x53,5 (2) 5,50
152010	1	Zócalo metal. ángulo M20-10A	42x41,5x53,5 (3) 8,50

(3) Disponible en PG11



1

2

3



CUBIERTAS 21x21

CÓDIGO	ENVASE EMBALAJE	DESCRIPCIÓN	€/ud
152011	1	Cubierta aisl. recta M20-10A	35x26,5x54 (1) 1,46
152012	1	Cubierta aisl. ángulo M20-10A	35x26,5x50 (2) 1,76
152013	1	Cubierta aisl. recta con cierre M20-10A	35x24x51 (2) 2,12
152014	1	Cubierta met. recta M20-10A	35x26,5x54 (1) 6,59
152015	1	Cubierta met. ángulo M20-10A	35x26,5x50 (2) 7,18
152016	1	Cubierta met. recta con cierre M20-10A	35x24x51 (3) 6,52

Disponibles en PG11



1

2

ACCESORIOS 21x21

CÓDIGO	ENVASE EMBALAJE	DESCRIPCIÓN	€/ud
152017	1	Tapa aislante zócalo o cubierta	35x26,5x17,5 (1) 1,46
152018	1	Tapa metálica zócalo o cubierta	35x26,5x17,5 (2) 6,96

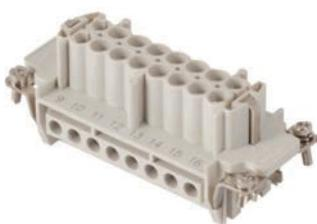

BASES 16 Amp. 500V/ 6kV CON TORNILLO

CÓDIGO	ENVASE EMBALAJE	DESCRIPCIÓN	€/ud
152021	1	Base 6 Polos+TT-16A	8,50
152022	1	Base 10 Polos+TT-16A	10,91
152023	1	Base 16 Polos+TT-16A	15,01
152024	1	Base 24 Polos+TT-16A	20,14

Disponibilidad de 32 y 48 polos, consultar.



CLAVIJAS 16 Amp. 500V/ 6kV CON TORNILLO

CÓDIGO	ENVASE EMBALAJE	DESCRIPCIÓN	€/ud
152027	1	Clavija 6 Polos+TT-16A	8,12
152028	1	Clavija 10 Polos+TT-16A	10,55
152029	1	Clavija 16 Polos+TT-16A	14,06
152030	1	Clavija 24 Polos+TT-16A	18,59

Disponibilidad de 32 y 48 polos, consultar.



ZÓCALOS EMPOTRAR CON MECANISMO CIERRE

CÓDIGO	ENVASE EMBALAJE	DESCRIPCIÓN	€/ud
152033	1	Zócalo emp. mec. cierre 6B 82x44x21,5 (1)	18,46
152034	1	Zócalo emp. mec. cierre 10B 95,5x53,5x29,5 (2)	24,60
152035	1	Zócalo emp. mec. cierre 16B 115,5x53,5x29,5 (2)	25,78
152036	1	Zócalo emp. mec. cierre 24B 142,5x53,5x29,5 (2)	27,38
152037	1	Zócalo emp. mec. cierre 32B 124,5x105x35,5 (2)	43,34

Ver tamaño en página 81



ZÓCALOS MURAL CON MECANISMO DE CIERRE

CÓDIGO	ENVASE EMBALAJE	DESCRIPCIÓN	€/ud
152038	1	Zócalo mural cierre 6B-1E 83,5x57x53 (1)	25,55
152039	1	Zócalo mural cierre 10B-1E 97x57x57 (2)	31,92
152040	1	Zócalo mural cierre 10B-2E 97x57x57 (2)	35,95
152041	1	Zócalo mural cierre 16B-1E 117x57x63 (2)	38,29
152042	1	Zócalo mural cierre 16B-2E 117x57x63 (2)	42,10
152043	1	Zócalo mural cierre 24B-1E 143,5x57x63 (2)	40,86
152044	1	Zócalo mural cierre 24B-2E 143,5x57x63 (2)	45,10
152045	1	Zócalo mural cierre 32B-1E 125x84,5x87,5 (2)	80,52
152046	1	Zócalo mural cierre 32B-2E 125x84,5x87,5 (2)	120,49

Ver tamaño en página 81

1 ENTRADA PARA MÉTRICA

152038	1xM20
152039	1xM20
152041	1xM25
152043	1xM25
152045	1xM40

2 ENTRADAS PARA MÉTRICA

152040	2xM20
152042	2xM25
152044	2xM25
152046	2xM40



CUBIERTAS SALIDA LATERAL

CÓDIGO	ENVASE EMBALAJE	DESCRIPCIÓN		€/ud
152047	1	Cubierta lateral 6B M20 - 2 Pivotes	(1)	10,76
152048	1	Cubierta lateral 10B M20 - 4 Pivotes	(2)	11,71
152049	1	Cubierta lateral 16B M25 - 4 Pivotes	(2)	14,06
152050	1	Cubierta lateral 24B M25 - 4 Pivotes	(2)	16,55

CÓDIGO	DIMENSIONES (mm)			
	A	B	C	Métrica
152047	60	43,5	47	20
152048	73,5	43,5	52	20
152049	94	43,5	63	25
152050	120,5	43,5	63	25



CUBIERTAS SALIDA RECTA

CÓDIGO	ENVASE EMBALAJE	DESCRIPCIÓN		€/ud
152051	1	Cubierta recta 6B M20 - 2 Pivote	(1)	10,98
152052	1	Cubierta recta 10B M20 - 4 Pivote	(2)	16,55
152053	1	Cubierta recta 16B M25 - 4 Pivote	(2)	14,72
152054	1	Cubierta recta 24B M25 - 4 Pivote	(2)	17,72
152055	1	Cubierta recta 32B M32 - 4 Pivote	(3)	57,66

CÓDIGO	DIMENSIONES (mm)			
	A	B	C	Métrica
152051	60	43,5	53	20
152052	73,5	43,5	58	20
152053	94	43,5	58	25
152054	120,5	43,5	68	25
152055	94	83	90	32



CUBIERTAS SALIDA RECTA CON MECANISMO DE CIERRE

CÓDIGO	ENVASE EMBALAJE	DESCRIPCIÓN		€/ud
152056	1	Cubierta recta 6B M20 - 1 Cierre	(1)	26,58
152057	1	Cubierta recta 10B M25 - 2 Cierres	(2)	37,49
152058	1	Cubierta recta 16B M25 - 2 Cierres	(2)	33,83
152059	1	Cubierta recta 24B M32 - 2 Cierres	(2)	42,97
152060	1	Cubierta recta 32B M32 - 2 Cierres	(3)	90,78

CÓDIGO	DIMENSIONES (mm)			
	A	B	C	Métrica
152056	60	43,5	53	20
152057	73,5	43,5	58	20
152058	94	43,5	58	25
152059	120,5	43,5	68	25
152060	94	83	90	32



PRENSAESTOPAS POLIAMIDA IP68 MÉTRICA Y PG

CÓDIGO	ENVASE EMBALAJE	DESCRIPCIÓN	Cierre/mm.	€/ud
150701	100	Pren. poli. M 12	2,5/6,5	0,80
150702	100	Pren. poli. M 16	2,8/8	0,98
150703	100	Pren. poli. M 16	3,5/10	0,86
150704	100	Pren. poli. M 20	5/12	0,98
150705	50	Pren. poli. M 20	7/14	0,98
150706	50	Pren. poli. M 25	9/18	1,68
150710	25	Pren. poli. M 32	14/25	3,36
150711	20	Pren. poli. M 40	18/32	7,08
150707	10	Pren. poli. M 50	24/38,5	11,16
150708	5	Pren. poli. M 63	35/48	12,01
150720	100	Pren. poli. PG 7	2,5/6,5	0,78
150721	100	Pren. poli. PG 9	2,5/8	0,83
150722	100	Pren. poli. PG 11	3,5/10	0,88
150723	100	Pren. poli. PG 13,5	5/12	1,00
150724	50	Pren. poli. PG 16	7/14	1,13
150725	50	Pren. poli. PG 21	9/18	1,70
150726	25	Pren. poli. PG 29	14/25	3,34
150727	10	Pren. poli. PG 36	18/32	7,22
150728	10	Pren. poli. PG 42	24/38,5	10,44
150729	10	Pren. poli. PG 48	35/48	12,22



TUERCAS POLIAMIDA MÉTRICA Y PG

CÓDIGO	ENVASE EMBALAJE	DESCRIPCIÓN	Llave	€/ud
150801	100	Tuerca poli. M 12	17	0,22
150802	100	Tuerca poli. M 16	22	0,23
150803	100	Tuerca poli. M 20	26	0,32
150804	100	Tuerca poli. M 25	32	0,51
150805	100	Tuerca poli. M 32	42	0,76
150806	50	Tuerca poli. M 40	52	1,41
150807	50	Tuerca poli. M 50	62	2,30
150808	50	Tuerca poli. M 63	78	3,53
150809	100	Tuerca poli. PG 7	15	0,21
150810	100	Tuerca poli. PG 9	19	0,21
150811	100	Tuerca poli. PG 11	22	0,22
150812	100	Tuerca poli. PG 13,5	24	0,25
150813	100	Tuerca poli. PG 16	27	0,31
150814	100	Tuerca poli. PG 21	32	0,50
150815	50	Tuerca poli. PG 29	41	0,74
150816	20	Tuerca poli. PG 36	54	1,25
150817	10	Tuerca poli. PG 42	62	2,22
150818	10	Tuerca poli. PG 48	67	2,82



RACOR JUDODIX MÉTRICA

CÓDIGO	ENVASE EMBALAJE	DESCRIPCIÓN	ø Interno	€/ud
150770	50	Racor Judodix M 12	7,5	3,89
150771	50	Racor Judodix M 16	9,2	3,96
150772	50	Racor Judodix M 20	11,9	4,50
150773	50	Racor Judodix M 20	13,6	5,08
150774	50	Racor Judodix M 25	15,3	4,75
150775	50	Racor Judodix M 25	20,2	7,62
150776	50	Racor Judodix M 32	20,2	8,38
150777	20	Racor Judodix M 32	26,7	12,88
150778	20	Racor Judodix M 40	26,7	14,64
150779	10	Racor Judodix M 40	34,6	24,46
150780	10	Racor Judodix M 50	34,6	29,38
150781	5	Racor Judodix M 63	45,3	60,45



RACOR JUDODIX PG

CÓDIGO	ENVASE EMBALAJE	DESCRIPCIÓN	€/ud
150782	50	Racor Judodix PG 7	3,72
150783	50	Racor Judodix PG 9	3,72
150784	50	Racor Judodix PG 11	4,55
150785	50	Racor Judodix PG 13,5	5,14
150786	50	Racor Judodix PG 16	5,39
150787	50	Racor Judodix PG 21	9,35
150788	20	Racor Judodix PG 29	14,26
150789	10	Racor Judodix PG 36	29,52
150790	5	Racor Judodix PG 48	54,65



PRENSAESTOPAS MÉTRICO Y PG

CÓDIGO	ENVASE EMBALAJE	DESCRIPCIÓN	Cierre/mm.	€/ud
150750	100	Pren. metal. M 12	3/6,5	3,38
150751	100	Pren. metal. M 16	4/8	3,77
150752	100	Pren. metal. M 20	6/12	5,06
150753	50	Pren. metal. M 25	10/14	6,82
150754	25	Pren. metal. M 32	13/18	11,65
150755	10	Pren. metal. M 40	18/25	17,26
150756	5	Pren. metal. M 50	22/32	33,85
150757	5	Pren. metal. M 63	34/44	55,35
150760	100	Pren. metal. PG 7	3/6,5	3,36
150761	100	Pren. metal. PG 9	4/8	3,98
150762	50	Pren. metal. PG 11	5/10	4,66
150763	50	Pren. metal. PG 13,5	6/12	5,68
150764	50	Pren. metal. PG 16	10/14	6,64
150765	50	Pren. metal. PG 21	13/18	11,13
150766	25	Pren. metal. PG 29	18/25	17,90
150767	10	Pren. metal. PG 36	24/32	33,92
150768	5	Pren. metal. PG 42	30/38	47,30
150769	5	Pren. metal. PG 48	34/44	55,51



TUERCAS METÁLICAS MÉTRICA Y PG

CÓDIGO	ENVASE EMBALAJE	DESCRIPCIÓN	Llave	€/ud
150819	100	Tuerca metálica M 12	15	0,37
150820	100	Tuerca metálica M 16	20	0,49
150821	100	Tuerca metálica M 20	24	0,67
150822	100	Tuerca metálica M 25	30	1,05
150823	50	Tuerca metálica M 32	35	1,51
150824	20	Tuerca metálica M 40	45	2,51
150825	10	Tuerca metálica M 50	55	4,67
150826	10	Tuerca metálica M 63	70	7,80
150827	100	Tuerca metálica PG 7	15	0,35
150828	100	Tuerca metálica PG 9	18	0,42
150829	100	Tuerca metálica PG 11	21	0,48
150830	100	Tuerca metálica PG 13,5	23	0,54
150831	100	Tuerca metálica PG 16	26	0,67
150832	100	Tuerca metálica PG 21	32	1,11
150833	50	Tuerca metálica PG 29	41	1,51
150834	20	Tuerca metálica PG 36	51	3,30
150835	10	Tuerca metálica PG 42	64	5,12
150836	10	Tuerca metálica PG 48	64	5,80



AMPLIACIONES METÁLICAS DE ROSCA MÉTRICA

CÓDIGO	ENVASE EMBALAJE	DESCRIPCIÓN	Long. rosca mm.	€/ud
150901	100	Ampliación metal. M12-M16	5	2,92
150902	100	Ampliación metal. M16-M20	6	3,70
150903	50	Ampliación metal. M20-M25	6,5	5,61
150904	50	Ampliación metal. M25-M32	6,5	9,48
150905	50	Ampliación metal. M32-M40	7	14,37
150906	10	Ampliación metal. M40-M50	9	24,09
150907	10	Ampliación metal. M50-M63	9	52,88

AMPLIACIONES METÁLICAS DE ROSCA PG

CÓDIGO	ENVASE EMBALAJE	DESCRIPCIÓN	Long. rosca mm.	€/ud
150910	100	Ampliación metal. PG 7-PG 9	5	1,78
150911	100	Ampliación metal. PG 9-PG 11	6	2,25
150912	100	Ampliación metal. PG 11-PG 13,5	6	2,48
150913	100	Ampliación metal. PG 11-PG 16	6,5	2,84
150914	100	Ampliación metal. PG 13,5-PG 16	6,5	2,84
150915	100	Ampliación metal. PG 16-PG 21	6,5	5,33
150916	50	Ampliación metal. PG 21-PG 29	7	9,41
150917	25	Ampliación metal. PG 29-PG 36	8	17,42
150918	10	Ampliación metal. PG 36-PG 42	9	25,16
150919	10	Ampliación metal. PG 42-PG 48	10	31,67

REDUCCIONES METÁLICAS DE ROSCA MÉTRICA

CÓDIGO	ENVASE EMBALAJE	DESCRIPCIÓN	Long. rosca mm.	€/ud
150920	100	Reducción metal. M16-M12	7 (1)	1,68
150921	100	Reducción metal. M20-M12	7 (1)	2,69
150922	100	Reducción metal. M20-M16	7 (1)	1,97
150923	100	Reducción metal. M25-M16	7 (1)	4,93
150924	100	Reducción metal. M25-M20	8 (1)	3,68
150925	50	Reducción metal. M32-M20	8 (2)	7,99
150926	50	Reducción metal. M32-M25	8,5 (1)	5,33
150927	25	Reducción metal. M40-M25	8 (2)	12,64
150928	25	Reducción metal. M40-M32	8 (2)	9,60
150929	10	Reducción metal. M50-M32	9 (2)	16,86
150930	10	Reducción metal. M50-M40	9 (2)	14,30
150931	10	Reducción metal. M63-M40	10 (2)	38,03
150932	10	Reducción metal. M63-M50	10 (2)	30,97

REDUCCIONES METÁLICAS DE ROSCA PG

CÓDIGO	ENVASE EMBALAJE	DESCRIPCIÓN	Long. rosca mm.	€/ud
150933	100	Reducción metal. PG 9-PG 7	6	1,39
150934	100	Reducción metal. PG 11-PG 7	6	1,98
150935	100	Reducción metal. PG 11-PG 9	6	1,45
150936	100	Reducción metal. PG 13,5-PG 9	6,5	1,78
150937	100	Reducción metal. PG 13,5-PG 11	6,5	1,47
150938	100	Reducción metal. PG 16-PG 9	6,5	2,22
150939	100	Reducción metal. PG 16-PG 11	6,5	1,84
150940	100	Reducción metal. PG 16-PG 13,5	6,5	1,57
150941	100	Reducción metal. PG 21-PG 11	7	5,30
150942	100	Reducción metal. PG 21-PG 13,5	7	4,50
150943	100	Reducción metal. PG 21-PG 16	7	3,28
150944	50	Reducción metal. PG 29-PG 16	8	9,94
150945	50	Reducción metal. PG 29-PG 21	8	5,34
150946	25	Reducción metal. PG 36-PG 21	9	15,18
150947	25	Reducción metal. PG 36-PG 29	9	12,58
150948	10	Reducción metal. PG 42-PG 36	10	18,92
150950	10	Reducción metal. PG 48-PG 36	10	23,92
150951	10	Reducción metal. PG 48-PG 42	10	24,80



ADAPTADORES METÁL. MACHO MÉTRICA - HEMBRA PG

CÓDIGO	ENVASE EMBALAJE	DESCRIPCIÓN	Long. rosca mm.	€/ud
150952	100	Adaptador metal. M12-PG7	5 (1)	1,91
150953	100	Adaptador metal. M12-PG9	5 (1)	2,80
150954	100	Adaptador metal. M16-PG9	5 (1)	2,35
150955	100	Adaptador metal. M16-PG11	6 (1)	3,09
150956	100	Adaptador metal. M20-PG11	6 (1)	2,26
150957	100	Adaptador metal. M20-PG13,5	6 (1)	2,28
150958	100	Adaptador metal. M20-PG16	6 (1)	2,44
150959	50	Adaptador metal. M25-PG13,5	7 (2)	3,18
150960	50	Adaptador metal. M25-PG16	7 (2)	3,69
150961	100	Adaptador metal. M25-PG21	7 (1)	4,14
150962	25	Adaptador metal. M32-PG16	8 (2)	5,81
150963	25	Adaptador metal. M32-PG21	8 (2)	6,42
150964	50	Adaptador metal. M32-PG29	8 (1)	6,45
150965	25	Adaptador metal. M40-PG21	8 (2)	12,00
150966	25	Adaptador metal. M40-PG29	8 (2)	13,96
150967	50	Adaptador metal. M40-PG36	8 (1)	18,29
150968	10	Adaptador metal. M50-PG36	9 (1)	32,47
150969	5	Adaptador metal. M50-PG42	9 (1)	32,78
150970	10	Adaptador metal. M63-PG36	10 (2)	27,78
150971	10	Adaptador metal. M63-PG42	10 (2)	27,90
150972	5	Adaptador metal. M63-PG48	10 (1)	47,16

1



2



**ADAPTADORES METÁL. MACHO PG - HEMBRA MÉTRICA**

CÓDIGO	ENVASE EMBALAJE	DESCRIPCIÓN	Long. rosca mm.	€/ud
150973	100	Adaptador metal. PG7-M12	6,5 (3)	4,32
150974	100	Adaptador metal. PG9-M16	6,5 (3)	4,37
150975	100	Adaptador metal. PG11-M16	7 (3)	4,40
150976	100	Adaptador metal. PG13,5-M20	7 (3)	6,12
150977	100	Adaptador metal. PG16-M20	6,5 (2)	6,42
150978	100	Adaptador metal. PG16-M25	8 (3)	7,05
150979	100	Adaptador metal. PG21-M25	7 (2)	7,70
150980	100	Adaptador metal. PG21-M32	8 (3)	26,78
150981	50	Adaptador metal. PG29-M40	8,5 (3)	34,06
150982	25	Adaptador metal. PG36-M50	8,5 (3)	76,65
150983	10	Adaptador metal. PG42-M63	10 (3)	86,86

TAPONES METÁLICOS ROSCA MÉTRICA - ROSCA PG

CÓDIGO	ENVASE EMBALAJE	DESCRIPCIÓN	Long. rosca mm.	€/ud
150851	50	Tapón metal. M 12	5	1,24
150852	50	Tapón metal. M 16	6	1,34
150853	50	Tapón metal. M 20	6,5	1,50
150854	20	Tapón metal. M 25	7	3,08
150855	20	Tapón metal. M 32	8	5,39
150856	20	Tapón metal. M 40	9	9,80
150857	10	Tapón metal. M 50	10	13,96
150858	5	Tapón metal. M 63	10	27,04
150859	50	Tapón metal. PG 7	6,5	0,92
150860	50	Tapón metal. PG 9	6,5	1,11
150861	50	Tapón metal. PG 11	7	1,49
150862	50	Tapón metal. PG 13,5	7	1,63
150863	50	Tapón metal. PG 16	6,5	1,97
150864	50	Tapón metal. PG 21	8	3,66
150865	50	Tapón metal. PG 29	7	6,59
150866	10	Tapón metal. PG 36	8	14,24
150867	5	Tapón metal. PG 42	8,5	20,37
150868	5	Tapón metal. PG 48	8,5	33,25

TAPONES POLIAMIDA ROSCA MÉTRICA - ROSCA PG

CÓDIGO	ENVASE EMBALAJE	DESCRIPCIÓN	Long. rosca mm.	€/ud
150870	100	Tapón poli. M 12	6	0,43
150871	100	Tapón poli. M 16	6	0,46
150872	100	Tapón poli. M 20	8	0,58
150873	100	Tapón poli. M 25	8	0,64
150874	50	Tapón poli. M 32	10	1,02
150875	20	Tapón poli. M 40	10	2,24
150876	20	Tapón poli. M 50	12	3,68
150877	20	Tapón poli. M 63	12	4,93
150878	100	Tapón poli. PG 7	6	0,45
150879	100	Tapón poli. PG 9	6	0,46
150880	100	Tapón poli. PG 11	6	0,50
150881	100	Tapón poli. PG 13,5	6	0,51
150882	100	Tapón poli. PG 16	6	0,54
150883	100	Tapón poli. PG 21	8	0,66
150884	100	Tapón poli. PG 29	8	1,28
150885	50	Tapón poli. PG 36	10	2,78
150886	50	Tapón poli. PG 42	10	3,71
150887	50	Tapón poli. PG 48	12	4,59



CADENAS PORTABLES

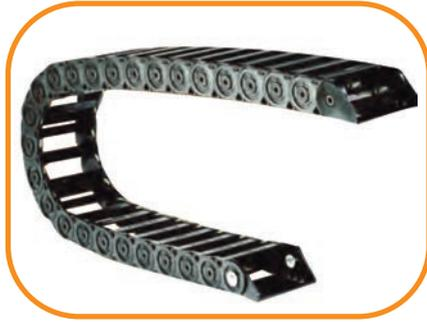

MINICANALES



CANALES DISTRIBUCIÓN



CUBRETUBOS ÓPTIMA



CAJAS VOZ Y DATOS



BANDEJA REJILLA



BANDEJAS METÁLICAS

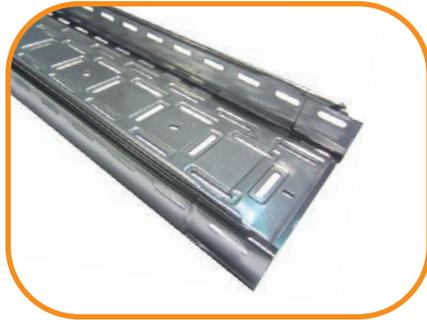

ACCESORIOS



SOPORTERÍAS



FIJACIONES



Las cadenas portables de la serie ligera permiten para un mismo eslabón de sección determinada, obtener diversos radios de curvatura mediante clips de color que define e identifican dicho radio.

En las cadenas portables todos los modelos tiene la posibilidad de apertura de los travesaños para facilitar la colocación y cambios de los cables.

Por su ligereza permiten grandes velocidades de desplazamiento. Debido al reducido peso intrínseco toleran, sin esfuerzo, aceleraciones y deceleraciones importantes.

Serie ligera en poliamida PA6.6 FV20 para aplicaciones con longitudes hasta 6 metros.



CADENA PORTACABLES LIGERA 3010

CÓDIGO	ENVASE EMBALAJE	DESCRIPCIÓN	€/m
151501	0,5	Mts. cadena A 30x30	121,20
151502	0,5	Mts. cadena B 30x40	124,24
151503	0,5	Mts. cadena D 30x60	134,60

- Tramos de 0,5 metros.
- Longitud autoportante 1 metro
- Máximo 6 metros

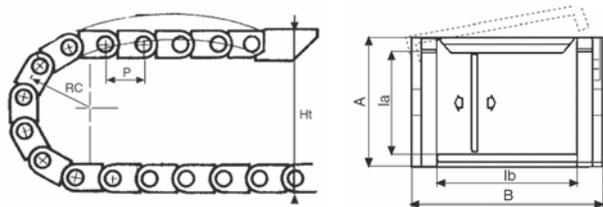

CÓDIGO	A	B	la	lb	P	Rc	Kg/m
151501	30	30	24	15	30	35-55-75-95	0,31
151502	30	40	24	25	30	35-55-75-95	0,33
151503	30	60	24	50	30	35-55-75-95	0,37

A: altura exterior del eslabón
 B: ancho exterior del eslabón
 la: altura interior útil
 lb: ancho interior útil
 Rc: radio de curvatura (10%)
 P: paso
 Ht: altura total (10%)
 T. mín.: -25°
 T. máx.: +130°

CLIPS PARA LA FORMACIÓN DEL RC

CÓDIGO	DESCRIPCIÓN	Ht	€/ud
	Sin clip para RC= 35 mm	103	Sin cargo
151505	Clip azul para RC= 55 mm	147	Sin cargo
151506	Clip verde para RC= 75 mm	191	Sin cargo
151507	Clip amarillo para RC= 95 mm	235	Sin cargo

- Se precisan 70 clips por metro de cadena.

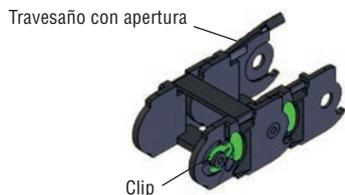

TERMINALES

CÓDIGO	ENVASE EMBALAJE	DESCRIPCIÓN	€/ud
151511	1	Terminal C-30 Inox. (juego 4 piezas)	(1) 54,45
151512	1	Terminal C-30x30 Poliamida (juego 2 piezas)	(2) 21,82
151513	1	Terminal C-30x40 Poliamida (juego 2 piezas)	24,24
151514	1	Terminal C-30x60 Poliamida (juego 2 piezas)	26,67

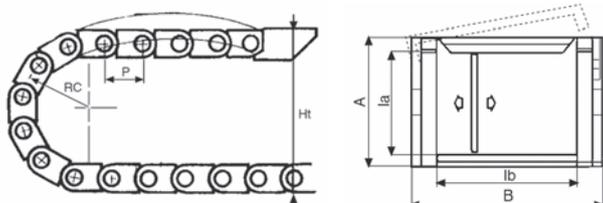

A: altura exterior del eslabón
 B: ancho exterior del eslabón
 la: altura interior útil
 lb: ancho interior útil
 Rc: radio de curvatura (10%)
 P: paso
 Ht: altura total (10%)
 T. mín.: -25°
 T. máx.: +130°

CADENA PORTACABLES LIGERA 4230

CÓDIGO	ENVASE EMBALAJE	DESCRIPCIÓN	€/m
151521	0,5	Mts. cadena A 40x54	196,32
151522	0,5	Mts. cadena B 40x74	201,58
151523	0,5	Mts. cadena C 40x94	207,06
151524	0,5	Mts. cadena D 40x114	212,56

- Tramos de 0,5 metros.
- Longitud autoportante 2 metros.
- Máximo 6 metros

CÓDIGO	A	B	la	lb	P	Rc	Kg/m
151521	40	54	34	40	42	55-105-155	0,60
151522	40	74	34	60	42	55-105-155	0,65
151523	40	94	34	80	42	55-105-155	0,67
151524	40	114	34	100	42	55-105-155	0,68

CLIPS PARA LA FORMACIÓN DEL RC

CÓDIGO	DESCRIPCIÓN	Ht	€/ud
151527	Clip azul para RC= 55 mm	176	Sin cargo
151528	Clip verde para RC= 105 mm	276	Sin cargo
151529	Clip amarillo para RC= 155 mm	376	Sin cargo

• Se precisan 50 clips por metro de cadena.

TERMINALES

CÓDIGO	ENVASE EMBALAJE	DESCRIPCIÓN	€/ud
151531	1	Terminal C-42 Inox. (juego 4 piezas)	(1) 42,02
151532	1	Terminal C-40x54 Poliamida (juego 2 piezas)	(2) 26,67
151533	1	Terminal C-40x74 Poliamida (juego 2 piezas)	29,32
151534	1	Terminal C-40x94 Poliamida (juego 2 piezas)	29,96
151535	1	Terminal C-40x114 Poliamida (juego 2 piezas)	31,55

PLETINAS FIJACIÓN CABLES

CÓDIGO	ENVASE EMBALAJE	DESCRIPCIÓN	€/ud
151536	1	Pletina fijación C-40x54 (juego 2 piezas)	(1) 16,93
151537	1	Pletina fijación C-40x74 (juego 2 piezas)	(2) 17,78
151538	1	Pletina fijación C-40x94 (juego 2 piezas)	18,64
151539	1	Pletina fijación C-40x114 (juego 2 piezas)	20,22

SEPARADOR VERTICAL

CÓDIGO	ENVASE EMBALAJE	DESCRIPCIÓN	€/ud
151540	1	Separador vertical C-4230 (ancho 3mm)	0,98



Modelo utilización

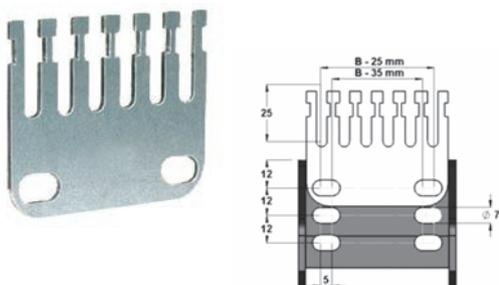

Consulte disponibilidad de cadenas portacables de mayor resistencia y capacidad



CANAL SALVACABLES

CÓDIGO	ENVASE EMBALAJE	DESCRIPCIÓN	€/m
400101	54	Mts. canaleta Salvacables CSC-1250	6,64
400102	36	Mts. canaleta Salvacables CSC-1875	11,44



MINICANAL

Blanco Ral 9016

CÓDIGO	ENVASE EMBALAJE	DESCRIPCIÓN	€/m
110201	120	Mts. minicanal MC-7x12	1,72
110202	70	Mts. minicanal MC-10x16	1,94
110203	48	Mts. minicanal MC-10x20	2,40
110204	32	Mts. minicanal MC-10x35/2	3,06
110206	40	Mts. minicanal MC-16x16	2,63
110207	24	Mts. minicanal MC-16x25	3,82
110208	64	Mts. minicanal MC-16x40/2	5,88
110209	40	Mts. minicanal MC-20x50/2	7,88
110210	40	Mts. minicanal MC-20x60/3	9,28



MINICANAL CON ADHESIVO

Blanco Ral 9016

CÓDIGO	ENVASE EMBALAJE	DESCRIPCIÓN	€/m
110221	120	Mts. minicanal MC-7x12 c/adh.	2,02
110222	70	Mts. minicanal MC-10x16 c/adh.	2,90
110223	48	Mts. minicanal MC-10x20 c/adh.	3,19



CAJAS

CÓDIGO	ENVASE EMBALAJE	DESCRIPCIÓN	€/ud
110271	12	Caja de conexiones minicanal	4,83
110272	12	Caja universal para 1 mecanismo	4,83

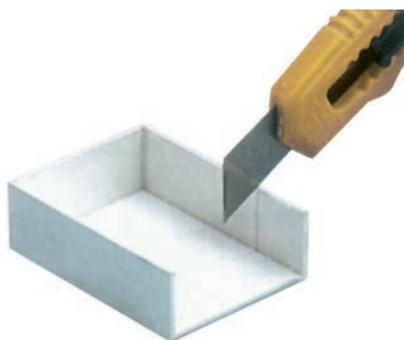

MULTIACCESORIO

CÓDIGO	ENVASE EMBALAJE	DESCRIPCIÓN	€/ud
110251	50	Multiaccesorio 7x12	3,62
110252	50	Multiaccesorio 10x16	4,24
110253	50	Multiaccesorio 10x20	6,19
110254	50	Multiaccesorio 10x35	7,52
110255	50	Multiaccesorio 16x16	6,20
110256	50	Multiaccesorio 16x25	6,90
110257	10	Multiaccesorio 16x40	7,70
110258	10	Multiaccesorio 20x50	9,66
110259	10	Multiaccesorio 20x60	13,58

MODO DE UTILIZACIÓN

Una sola pieza soluciona todos los problemas de instalación.

ÁNGULO INTERIOR



ÁNGULO EXTERIOR

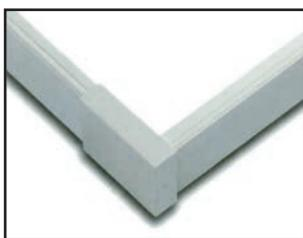

ÁNGULO PLANO

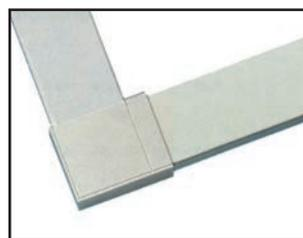

DERIVACIÓN EN T



UNIÓN

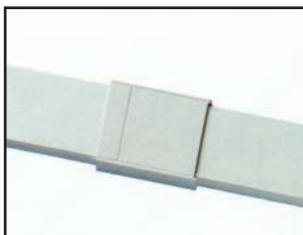

TAPA FINAL

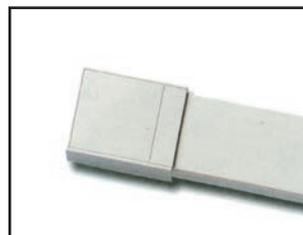

ALICATE DE CORTE

CÓDIGO	ENVASE EMBALAJE	DESCRIPCIÓN	€/ud
110308	1	Alicate universal	179,08

TACOS DE FIJACIÓN

CÓDIGO	ENVASE EMBALAJE	DESCRIPCIÓN	€/ud
110301	100	Taco fijación rápida 5x25	0,20
110302	100	Taco fijación rápida 5x35	0,22
110303	100	Taco fijación rápida 6x40	0,25

CINTA ADHESIVA DOBLE CARA

CÓDIGO	ENVASE EMBALAJE	DESCRIPCIÓN	€/m
100851	50	Mts. cinta adhesiva doble cara 8 mm.	1,31
100852	50	Mts. cinta adhesiva doble cara 13 mm.	1,99



CANAL PARA DISTRIBUCIÓN Y MECANISMOS

CÓDIGO	ENVASE EMBALAJE	DESCRIPCIÓN	€/m
120111	28	Mts.canal CDM-40x60	9,74
120112	24	Mts.canal CDM-40x60t (con tabique separador)	10,68
120113	12	Mts.canal CDM-40x90	14,51
120114	12	Mts.canal CDM-40x110	17,86
120116	16	Mts.canal CDM-60x90	17,50
120117	8	Mts.canal CDM-60x110	20,67
120119	8	Mts.canal CDM-60x150	30,28
120120	8	Mts.canal CDM-60x200	36,69

TABIQUE SEPARADOR

CÓDIGO	ENVASE EMBALAJE	DESCRIPCIÓN	€/m
120391	100	Mts. tabique separador 40	2,65
120392	100	Mts. tabique separador 60	6,84

ACCESORIOS CANAL CDM

CÓDIGO	ENVASE EMBALAJE	DESCRIPCIÓN	€/ud
120202	2	Ángulo interior 40x60	7,55
120203	2	Ángulo interior 40x90	8,37
120204	2	Ángulo interior 40x110	10,34
120206	2	Ángulo interior 60x90	10,63
120207	2	Ángulo interior 60x110	12,01
120209	2	Ángulo interior 60x150	18,87
120210	2	Ángulo interior 60x200	21,93
120222	2	Ángulo exterior 40x60	7,55
120223	2	Ángulo exterior 40x90	8,37
120224	2	Ángulo exterior 40x110	10,34
120226	2	Ángulo exterior 60x90	10,63
120227	2	Ángulo exterior 60x110	12,01
120229	2	Ángulo exterior 60x150	18,87
120230	2	Ángulo exterior 60x200	21,93
120242	2	Ángulo plano 40x60	10,68
120243	2	Ángulo plano 40x90	11,98
120244	2	Ángulo plano 40x110	13,04
120246	2	Ángulo plano 60x90	14,40
120247	2	Ángulo plano 60x110	15,82
120249	2	Ángulo plano 60x150	21,16
120250	2	Ángulo plano 60x200	24,45
120262	10	Tapa final 40x60	3,77
120263	10	Tapa final 40x90	4,03
120264	10	Tapa final 40x110	4,53
120266	10	Tapa final 60x90	4,68
120267	10	Tapa final 60x110	5,86
120269	10	Tapa final 60x150	7,35
120270	10	Tapa final 60x200	9,79

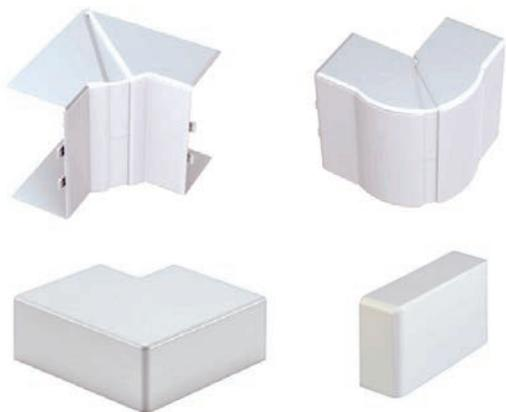

PORTAMECANISMOS Y CAJAS CANAL CDM

CÓDIGO	ENVASE EMBALAJE	DESCRIPCIÓN	€/ud
120313	10	Portamecanismos 90	6,63
120314	10	Portamecanismos 110	6,98
120319	10	Portamecanismos 150-2M 2 mecanismos	11,02
120332	12	Caja mecanismos GED-50	6,29
120333	12	Caja mecanismos GED-50-2M 2 mecanismos	12,37

CANAL PARA MECANISMOS 45X45 FIJ. DIRECTA

CÓDIGO	ENVASE EMBALAJE	DESCRIPCIÓN	€/m
120134	8	Mts. canal CM-65x100/45	23,21
120135	8	Mts. canal CM-65x130/2x45	28,20

ACCESORIOS CANAL CM

CÓDIGO	ENVASE EMBALAJE	DESCRIPCIÓN	€/ud
120271	1	Ángulo interior 65x100 ajustable	22,32
120272	1	Ángulo interior 65x130 ajustable	25,46
120273	1	Ángulo exterior 65x100 ajustable	22,33
120274	1	Ángulo exterior 65x130 ajustable	25,45
120275	1	Ángulo plano 65x100	29,65
120276	1	Ángulo plano 65x130	31,34
120277	10	Tapa final 65x100	7,06
120278	10	Tapa final 65x130	9,31

MECANISMOS PARA CANALES

CÓDIGO	ENVASE EMBALAJE	DESCRIPCIÓN	€/ud
120801	10	Base Schuko 2P+TT blanca	11,17
120802	10	Base Schuko 2P+TT roja	12,18
120808	10	Placa ciega estrecha	5,32
120809	10	Placa ciega ancha	5,53

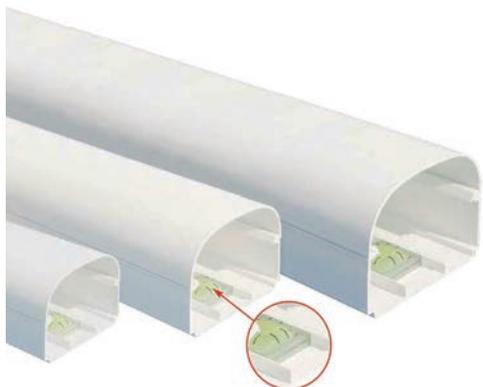

Nivel incorporado

CANAL CUBRETUBOS "ÓPTIMA" CON NIVEL

CÓDIGO	ENVASE EMBALAJE	DESCRIPCIÓN	€/m
110601	28	Mts. canal Cubretubos Óptima CTO-N 46x62	8,20
110602	20	Mts. canal Cubretubos Óptima CTO-N 55x75	10,23
110603	14	Mts. canal Cubretubos Óptima CTO-N 66x102	13,55



Antes



Ahora



1



2



3



4



5



6



7



8

ACCESORIOS CANAL ÓPTIMA

CÓDIGO	ENVASE EMBALAJE	DESCRIPCIÓN	€/ud
110611	5	Ángulo interior Óptima AI-62 OP (1)	4,68
110612	5	Ángulo interior Óptima AI-75 OP	5,72
110613	3	Ángulo interior Óptima AI-102 OP	5,89
110614	5	Ángulo exterior Óptima AE-62 OP (2)	4,68
110615	5	Ángulo exterior Óptima AE-75 OP	5,72
110616	3	Ángulo exterior Óptima AE-102 OP	5,89
110617	5	Ángulo plano Óptima AP-62 OP (3)	5,02
110618	5	Ángulo plano Óptima AP-75 OP	5,73
110619	3	Ángulo plano Óptima AP-102 OP	6,87
110620	1	Ángulo plano artic. Óptima APA-62 OP (4)	12,31
110621	1	Ángulo plano artic. Óptima APA-75 OP	14,89

CÓDIGO	ENVASE EMBALAJE	DESCRIPCIÓN	€/ud
110622	5	Derivacion "T" Óptima DT-62 OP (5)	12,61
110623	5	Derivacion "T" Óptima DT-75 OP	6,86
110624	3	Derivacion "T" Óptima DT-102 OP	9,04
110625	5	Unión Óptima U-62 OP (6)	2,95
110626	5	Unión Óptima U-75 OP	3,12
110627	3	Unión Óptima U-102 OP	3,41
110628	5	Tapa final Óptima TF-62 OP (7)	3,58
110629	5	Tapa final Óptima TF-75 OP	3,93
110630	3	Tapa final Óptima TF-105 OP	4,92
110631	5	Reducción Óptima R-75/62 OP (8)	4,92
110632	3	Reducción Óptima R-102/75 OP	9,04



ACCESORIOS CANAL ÓPTIMA

CÓDIGO	ENVASE EMBALAJE	DESCRIPCIÓN	€/ud
110633	5	Terminal salida curva Opt. TSC-62 OP (1)	4,09
110634	5	Terminal salida curva Opt. TSC-75 OP	4,67
110635	3	Terminal salida curva Opt. TSC-102 OP	6,14
110636	5	Terminal salida recta Opt. TSR-62 OP (2)	3,07
110637	5	Terminal salida recta Opt. TSR-75 OP	3,83
110638	3	Terminal salida recta Opt. TSR-102 OP	4,42
110639	5	Terminal salida tubo Opt. TST-62 OP (3)	2,86
110640	5	Terminal salida tubo Opt. TST-75 OP	3,12
110641	3	Terminal salida tubo Opt. TST-102 OP	3,83
110642	20	Acoplamiento flexible Opt. AF-62 OP (4)	13,69
110643	20	Acoplamiento flexible Opt. AF-75 OP	16,15
110644	20	Acoplamiento flexible Opt. AF-102 OP	18,11
110645	20	Retenedor tubos FT-62 OP (5)	0,83
110646	20	Retenedor Fijación tubos FT-75 OP	0,97
110647	20	Retenedor Fijación tubos FT-102 OP	1,05



CÓDIGO	ENVASE EMBALAJE	DESCRIPCIÓN	€/ud
110648	5	Placa acabado externo PAE-OP (1)	4,59
110649	5	Placa anti-roces PAR-OP (2)	4,29
110650	1	Kit anti-roces KAR-OP (3)	6,26
110651	1	Kit anti-roces-placa acabado ext. KAR-OP (4)	11,93



CÓDIGO	ENVASE EMBALAJE	DESCRIPCIÓN	€/ud
110652	1	Alicate corte Óptima	444,22
110653	1	Repuesto hoja de corte Óptima	136,22





CANAL ÓPTIMA PARA TUBO DESCARGA

CÓDIGO	ENVASE EMBALAJE	DESCRIPCIÓN	€/m
110701	80	Mts. canal tubo descarga CTD-28x35	4,84



ACCESORIOS CANAL DESCARGA

CÓDIGO	ENVASE EMBALAJE	DESCRIPCIÓN	€/ud
110711	20	Ángulo interior AID-35	2,77
110712	20	Ángulo exterior AED-35	2,77
110713	20	Ángulo plano APD-35	3,23
110714	20	Unión UD-35	1,62
110715	20	Tapa Final TFD-35	2,43
110716	20	Terminal Salida Pared TSPD-35	2,43



MINIBOMBA CONDENSACIÓN MONTAJE EN CANAL

CÓDIGO	ENVASE EMBALAJE	DESCRIPCIÓN	€/ud
110751	1	Mini bomba cond. BCC-7 Litros	133,69
110752	1	Mini bomba cond. BCC-11 Litros	150,14
110753	1	Mini bomba cond. BCC-15 Litros	157,37
110754	1	Mini bomba cond. BCC-20 Litros	183,60

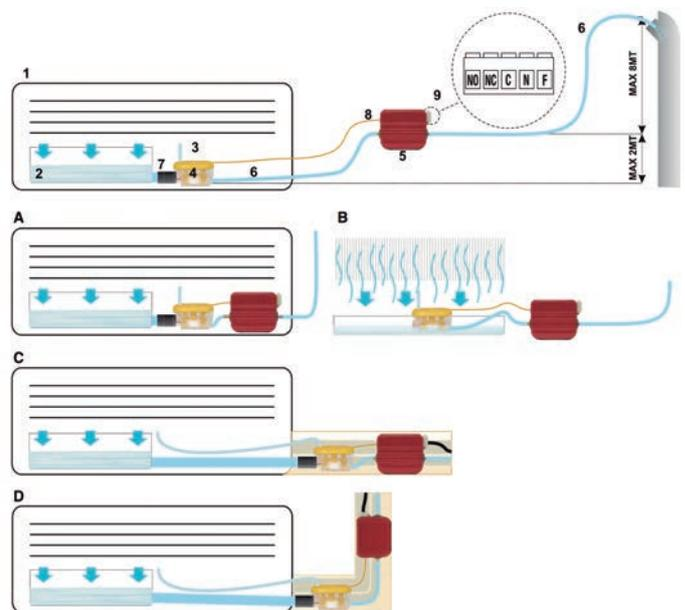

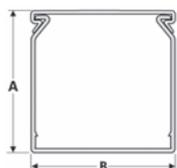

CANAL CUBRETUBOS

CÓDIGO	ENVASE EMBALAJE	DESCRIPCIÓN	A x B	€/m
110503	50	Mts. canal cubre CT-30x30		4,89
110504	40	Mts. canal cubre CT-40x40		8,75
110505	36	Mts. canal cubre CT-40x60		9,34
110507	32	Mts. canal cubre CT-60x60		10,62
110508	24	Mts. canal cubre CT-60x80		13,01
110509	16	Mts. canal cubre CT-60x100		17,61
110510	16	Mts. canal cubre CT-60x120		18,45

*Esta canal no dispone de accesorios.
Color Ral 9010.*



SOPORTES ANTIVIBRATORIOS

CÓDIGO	ENVASE EMBALAJE	DESCRIPCIÓN	€/ud
110581	1	Juego antivibr. sop. pared 38x38	8,24
110582	1	Juego antivibr. sop. pared 40x26	8,75
110583	1	Juego antivibr. sop. pared 50x35	10,81
110584	1	Juego antivibr. sop. suelo 48x19	8,72
110585	1	Juego antivibr. sop. suelo 56x21	9,92
110586	1	Juego antivibr. sop. suelo 74x26	18,66



SOPORTES AMORTIGUADORES "GENIUS"

CÓDIGO	ENVASE EMBALAJE	DESCRIPCIÓN	€/ud
110801	1	Soporte A. Genius-1000 negro (1)	6,80
110802	1	Soporte A. Genius-1000 marfil	7,24
110803	1	Sop. A. reg. Genius-1000R fij. rápida negro	10,27
110804	1	Sop. A. reg. Genius-1000R fij. rápida marfil (2)	10,88
110805	1	Sop. A. reg. Genius-1000R fij. tor. M10 Negro	11,98
110806	1	Sop. A. reg. Genius-1000R fij. tor. M10 marfil	12,60
110807	1	Sop. A. reg. Genius-1500R fij. rápida negro (3)	87,21
110808	1	Sop. A. reg. Genius-1500R fij. tor. M10 negro	88,03
110810	1	Herramienta Regulación (4)	28,48

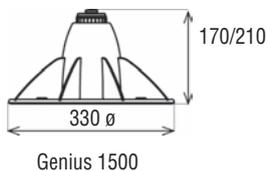
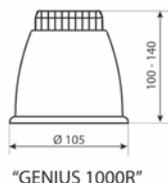
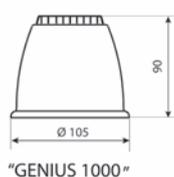

Nivel incorporado





CONJUNTO SOPORTE MODULAR "GENIUS"

CÓDIGO	ENVASE EMBALAJE	DESCRIPCIÓN	€/ud
110821	1	Conj. sop. reg. Genius-1500 modular 1	654,79
110822	1	Conj. sop. reg. Genius-1500 modular 2	1.063,97
110823	1	Conj. sop. reg. Genius-1500 modular 3	1.438,71

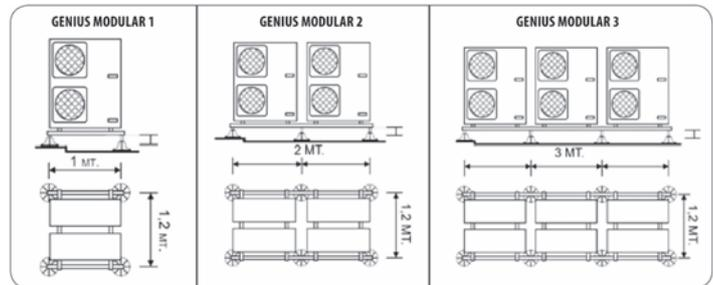

Nivel incorporado

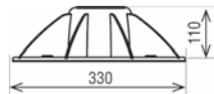

Perfil 41x41



Tubo 40x40



Tubo Redondo 50 ø

SOPORTES AMORTIGUADORES "HÉRCULES"

CÓDIGO	ENVASE EMBALAJE	DESCRIPCIÓN	€/ud
110811	1	Soporte amort. Hércules-2000/100	56,80
110812	1	Soporte amort. reg Hércules-2000/150-300	168,10
110813	1	Soporte amort. reg Hércules-2000/150-400	175,92

CONJUNTO SOPORTE MODULAR "HÉRCULES"

CÓDIGO	ENVASE EMBALAJE	DESCRIPCIÓN	€/ud
110831	1	C. sop. reg. Hércules-2000/1 mod. 150/300	1.400,41
110832	1	C. sop. reg. Hércules-2000/1 mod. 150/400	1.431,75
110834	1	C. sop. reg. Hércules-2000/2 mod. 150/300	2.232,74
110835	1	C. sop. reg. Hércules-2000/2 mod. 150/400	2.279,79
110837	1	C. sop. reg. Hércules-2000/3 mod. 150/300	3.144,55
110838	1	C. sop. reg. Hércules-2000/3 mod. 150/400	3.207,26

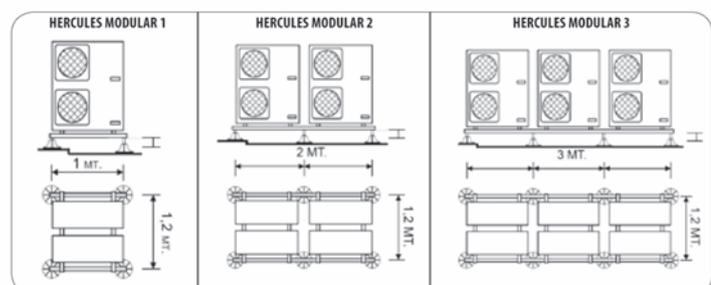



CAJAS VOZ Y DATOS

CÓDIGO	ENVASE EMBALAJE	DESCRIPCIÓN	€/ud
160101	1	Caja superficie SVD-1 (2 mecanismos)	12,97
160102	1	Caja superficie SVD-2 (4 mecanismos)	18,88
160103	1	Caja superficie SVD-3 (6 mecanismos)	25,28
160104	1	Caja superficie SVD-4 (8 mecanismos)	35,74
160152	1	Caja empotrar EVD-2 (4 mecanismos)	29,36
160153	1	Caja empotrar EVD-3 (6 mecanismos)	33,82



KIT CAJA Y MECANISMOS

CÓDIGO	ENVASE EMBALAJE	DESCRIPCIÓN	€/ud
160106	1	Kit superficie 1BD+1RD+2(1 RJ)	75,61
160107	1	Kit superficie 2BD+2(1 RJ)	75,61
160111	1	Kit superficie 2BD+1RD+2(1 RJ)	94,13
160112	1	Kit superficie 2BD+1RD+2(2 RJ)	95,60
160113	1	Kit superficie 3BD+2(2 RJ)	95,60
160156	1	Kit empotrar 1BD+1RD+2(1 RJ)	84,15
160157	1	Kit empotrar 2BD+2(1 RJ)	84,14

Nota: los mecanismos no están cableados



CAJA PARA FALSO SUELO

CÓDIGO	ENVASE EMBALAJE	DESCRIPCIÓN	€/ud
160161	1	Caja empotrar falso suelo CFS-6 (6 mec.)	(1) 89,68
160162	1	Accesorio para pavimento	(2) 64,81
160163	1	Tapa embellecedora de enrasamiento	10,60

PLACAS MONTAJE MEC. Y BASES DOBLES PARA CAJAS

CÓDIGO	ENVASE EMBALAJE	DESCRIPCIÓN	€/ud
160181	1/25	Placa doble 2 MEC 45x45	3,31
160182	1/10	Placa ciega doble 45x90	5,29
160183	1/10	Placa ciega 45 x 22.5	0,71
160184	1/10	Placa ciega 45 x 45	0,78
160211	1/10	Base Schuko doble blanca	(1) 18,62
160212	1/10	Base Schuko doble roja	18,62
160213	1/10	Base Schuko 45x45 blanca	(2) 9,23
160214	1/10	Base Schuko 45x45 roja	9,23





TORRETAS ALUMINIO PARA MECANISMO 45x45

CÓDIGO	ENVASE EMBALAJE	DESCRIPCIÓN	€/ud
160431	1	Torreta aluminio simple TAS-5M	101,43
160432	1	Torreta aluminio simple TAS-6M	104,79
160433	1	Torreta aluminio simple TAS-8M	112,93
160435	1	Torreta aluminio doble TAD-10M	143,47
160436	1	Torreta aluminio doble TAD-12M	156,34
160437	1	Torreta aluminio doble TAD-16M	164,32

Las torretas se suministran sin mecanismos.

Resto de mecanismos 45x45 son válidos para perfil y torretas.



Los perfiles se suministran sin mecanismos.

PERFIL RECTO ALUMINIO PARA MECANISMOS

CÓDIGO	ENVASE EMBALAJE	DESCRIPCIÓN	€/ud
160401	1	Perfil PM-5 mecanismos	46,28
160402	1	Perfil PM-6 mecanismos (1)	58,12
160403	1	Perfil PM-8 mecanismos	68,86
160404	1	Perfil PM-12 mecanismos	72,32
160411	1	Tapa lateral con prensaestopa PG16 (2)	4,77
160413	1	Tapa lateral para 2 conex. rápida (3)	4,95
160417	1	Tapa lateral con cono pasacable (4)	4,41
160418	1	Acoplamiento magnetotérmico o diferencial (5)	7,29



PERFIL ÁNGULO ALUM. PARA MECANISMOS

CÓDIGO	ENVASE EMBALAJE	DESCRIPCIÓN	€/ud
160406	1	Perfil ángulo PMA-5M (1)	44,67
160407	1	Perfil ángulo PMA-6M	47,94
160408	1	Perfil ángulo PMA-8M	54,97
160415	1	Tapa lateral con 2 conexiones Wago (2)	25,48
160416	1	Soporte sobremesa perfil ángulo (3)	38,97



PERFIL CIRCULAR EMPOTRAR CON CARGADOR

CÓDIGO	ENVASE EMBALAJE	DESCRIPCIÓN	€/ud
160455	1	Perfil empotrar circular Negro	113,18
160456	1	Perfil empotrar circular Blanco	140,55
160457	1	Adaptador perfil circular HDMI	13,66
160458	1	Adaptador perfil circular RJ hembra-hembra	9,29
160459	1	Adaptador perfil circular USB hembra-hembra	5,86

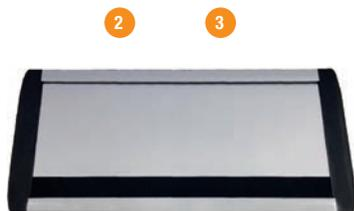

PERFIL EMPOTRAR MOBILIARIO

CÓDIGO	ENVASE EMBALAJE	DESCRIPCIÓN	€/ud
160440	1	Perfil empotrar PME-4M	(1) 85,83
160441	1	Perfil empotrar PME-5M	92,61
160442	1	Perfil empotrar PME-6M	97,23
160446	1	Perfil basculante empotrar PBE-2N4H	(2) 111,28
160447	1	Perfil basculante empotrar PBE-2N6H	119,29
160448	1	Perfil basculante empotrar PBE-3N6H	127,30
160449	1	Latiguillo 3Mts. con shucko y Wago	49,18
160451	1	Perfil basculante empotrar PBN-4M	(3) 67,35
160452	1	Perfil basculante empotrar PBN-5M	74,74
160453	1	Perfil basculante empotrar PBN-6M	83,52

BASES SCHUKO PARA PERFIL Y TORRETAS

CÓDIGO	ENVASE EMBALAJE	DESCRIPCIÓN	€/ud
160213	1/10	Base Schuko 45x45 blanca	(1) 9,23
160214	1/10	Base Schuko 45x45 roja	9,23
160421	1	Base Schuko doble p/perfil blanca	21,86
160422	1	Base Schuko doble p/perfil roja	21,86
160423	1	Base Schuko triple p/perfil blanca	26,06
160424	1	Base Schuko triple p/perfil roja	26,06
160425	1	Base Schuko cuádruple p/perfil blanca	31,27
160426	1	Base Schuko cuádruple p/perfil roja	31,27
160215	1/10	Módulo multimedia VGA hembra 15 vias	(2) 26,42
160216	1/10	Módulo multimedia MINI-JACK 3.5 mm	18,93
160217	1/10	Módulo multimedia 3 RCA (Video + Audio)	27,44
160218	1/10	Módulo multimedia USB hembra Tipo A	19,94
160219	1/10	Módulo multimedia HDMI hembra	31,25
160220	1/10	Módulo multimedia TV-macho	25,79
160221	1/10	Módulo multimedia Tipo BNC (sin conector)	6,76
160231	1/10	Caratula estrecha 1RJ45 (SYST.-KEYS)	(3) 4,98
160232	1/10	Caratula ancha 1RJ45 (SYST.-KEYS)	5,25
160233	1/10	Caratula ancha 2RJ45 (SYST.-KEYS)	5,72
160234	1/10	Caratula 45° ancha 2RJ45 (SYST.-KEYS)	7,03
160251	1/20	Conector H RJ45 - 5 UTP	(4) 5,17
160253	1/20	Conector H RJ45 - 6 UTP	6,38
160254	1/20	Conector H RJ45 - 6 FTP	13,11
160255	1/20	Conector M RJ45 - 5 UTP	2,13
160256	1/20	Conector M RJ45 - 6 UTP	3,18

LATIGUILLOS

CÓDIGO	ENVASE EMBALAJE	DESCRIPCIÓN	€/ud
160621	1	Latiguillo CAT 6 E -UTP 0.5 m	2,86
160622	1	Latiguillo CAT 6 E -UTP 1 m	3,73
160623	1	Latiguillo CAT 6 E -UTP 2 m	5,56
160624	1	Latiguillo CAT 6 E -UTP 3 m	7,39
160626	1	Latiguillo CAT 6 E -UTP 5 m	12,65
160631	1	Latiguillo CAT 6 E -FTP 0,5 m	3,30
160632	1	Latiguillo CAT 6 E -FTP 1 m	4,07
160633	1	Latiguillo CAT 6 E -FTP 2 m	6,49
160634	1	Latiguillo CAT 6 E -FTP 3 m	7,48
160636	1	Latiguillo CAT 6 E -FTP 5 m	10,99
160637	1	Latiguillo CAT 6 E -FTP 10 m	18,42
160638	1	Latiguillo CAT 6 E -FTP 15 m	46,29
160639	1	Latiguillo CAT 6 E -FTP 20 m	65,01



BANDEJA REJILLA ZINCADA

CÓDIGO	ENVASE EMBALAJE	DESCRIPCIÓN	€/m
070101	24	Mts. bandeja rejilla 30x100 zinc.	16,81
070102	18	Mts. bandeja rejilla 30x200 zinc.	24,31
070103	18	Mts. bandeja rejilla 30x300 zinc.	32,03
070216	24	Mts. bandeja rejilla 60x60 zinc.	16,59
070217	24	Mts. bandeja rejilla 60x70 zinc.	16,61
070201	24	Mts. bandeja rejilla 60x100 zinc.	19,11
070215	24	Mts. bandeja rejilla 60x150 zinc.	21,73
070202	12	Mts. bandeja rejilla 60x200 zinc.	26,15
070203	12	Mts. bandeja rejilla 60x300 zinc.	38,04
070204	6	Mts. bandeja rejilla 60x400 zinc.	49,91
070205	6	Mts. bandeja rejilla 60x500 zinc.	65,84
070206	6	Mts. bandeja rejilla 60x600 zinc.	73,34
070302	6	Mts. bandeja rejilla 110x200 zinc.	39,71
070303	6	Mts. bandeja rejilla 110x300 zinc.	50,69
070304	6	Mts. bandeja rejilla 110x400 zinc.	67,67
070305	6	Mts. bandeja rejilla 110x500 zinc.	76,79
070306	6	Mts. bandeja rejilla 110x600 zinc.	84,30

ACABADO "HR"

El acabado "HR" ofrece una alta resistencia a la corrosión superior al galvanizado en caliente, superando las 1000 horas en el ensayo de niebla salina sin aparición de corrosión roja.

GRADO 8 según norma IEC 61537

El acabo "HR" tiene un efecto auto-reparador en cortes y rozaduras.

Asimismo, está libre de puntas e irregularidades agresivas para cables e instaladores.

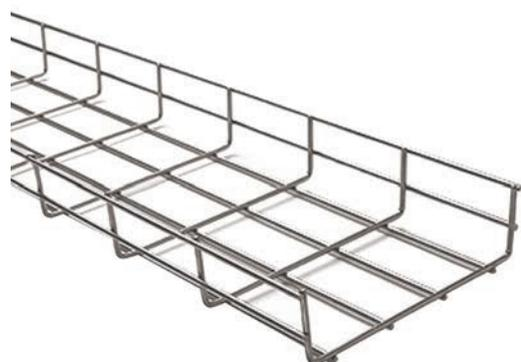

BANDEJA REJILLA GALVANIZADA "HR"

CÓDIGO	ENVASE EMBALAJE	DESCRIPCIÓN	€/m
071216-HR	24	Mts. bandeja rejilla 60x60 HR	19,95
071217-HR	24	Mts. bandeja rejilla 60x70 HR	19,97
071201-HR	24	Mts. bandeja rejilla 60x100 HR	23,47
071215-HR	24	Mts. bandeja rejilla 60x150 HR	26,88
071202-HR	12	Mts. bandeja rejilla 60x200 HR	32,18
071203-HR	12	Mts. bandeja rejilla 60x300 HR	46,18
071204-HR	6	Mts. bandeja rejilla 60x400 HR	56,01
071205-HR	6	Mts. bandeja rejilla 60x500 HR	76,39
071206-HR	6	Mts. bandeja rejilla 60x600 HR	84,84
071302-HR	6	Mts. bandeja rejilla 110x200 HR	52,82
071303-HR	6	Mts. bandeja rejilla 110x300 HR	64,82
071304-HR	6	Mts. bandeja rejilla 110x400 HR	91,82
071305-HR	6	Mts. bandeja rejilla 110x500 HR	103,93
071306-HR	6	Mts. bandeja rejilla 110x600 HR	117,60

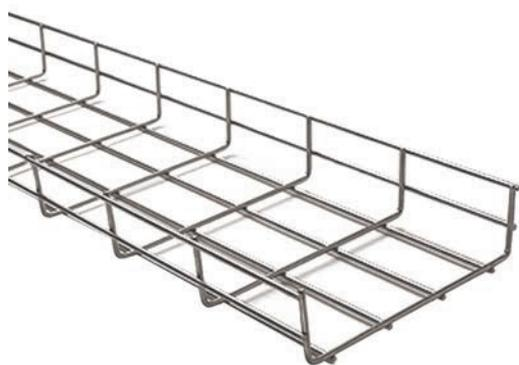

BANDEJA REJILLA INOXIDABLE

CÓDIGO	ENVASE EMBALAJE	DESCRIPCIÓN	€/m
072219	24	Mts Bandeja rejilla 60x60 inox.	55,23
072217	24	Mts. Bandeja rejilla 60x70 inox.	56,54
072201	24	Mts. bandeja rejilla 60x100 inox.	74,92
072215	24	Mts. bandeja rejilla 60x150 inox.	84,56
072202	12	Mts. bandeja rejilla 60x200 inox.	103,22
072203	12	Mts. bandeja rejilla 60x300 inox.	146,68
072204	6	Mts. bandeja rejilla 60x400 inox.	180,67
072205	6	Mts. bandeja rejilla 60x500 inox.	210,57
072206	6	Mts. bandeja rejilla 60x600 inox.	249,03
072212	6	Mts. bandeja rejilla 110x200 inox.	151,08
072213	6	Mts. bandeja rejilla 110x300 inox.	188,05
072214	6	Mts. bandeja rejilla 110x400 inox.	222,01
072218	6	Mts. bandeja rejilla 110x500 inox.	252,13
072216	6	Mts. bandeja rejilla 110x600 inox.	290,70



TAPA BANDEJA SENDZIMIR

CÓDIGO	ENVASE EMBALAJE	DESCRIPCIÓN	€/m
080901	24	Mts. tapa 60 sendzimir	19,92
080900	24	Mts. tapa 70 sendzimir	21,38
080902	24	Mts. tapa 100 sendzimir	15,77
080903	12	Mts. tapa 150 sendzimir	21,20
080904	12	Mts. tapa 200 sendzimir	25,92
080905	6	Mts. tapa 300 sendzimir	43,97
080906	6	Mts. tapa 400 sendzimir	59,90
080907	6	Mts. tapa 500 sendzimir	84,74
080908	6	Mts. tapa 600 sendzimir	100,36

TAPA BANDEJA "HR"

CÓDIGO	ENVASE EMBALAJE	DESCRIPCIÓN	€/m
081901	24	Mts. tapa 60 HR	28,28
081900	24	Mts. tapa 70 HR	30,59
081902	24	Mts. tapa 100 HR	30,32
081903	12	Mts. tapa 150 HR	42,89
081904	12	Mts. tapa 200 HR	52,81
081905	6	Mts. tapa 300 HR	80,37
081906	6	Mts. tapa 400 HR	111,08
081907	6	Mts. tapa 500 HR	150,66
081908	6	Mts. tapa 600 HR	176,29



TAPA REJILLA INOXIDABLE

CÓDIGO	ENVASE EMBALAJE	DESCRIPCIÓN	€/m
072259	24	Mts. tapa 60 inox.	53,50
072257	24	Mts. tapa 70 inox.	61,64
072251	24	Mts. tapa 100 inox.	67,25
072258	24	Mts. tapa 150 inox.	97,60
072252	12	Mts. tapa 200 inox.	122,80
072253	6	Mts. tapa 300 inox.	172,46
072254	6	Mts. tapa 400 inox.	222,34
072255	6	Mts. tapa 500 inox.	272,12
072256	6	Mts. tapa 600 inox.	324,09



TABIQUE SEPARADOR SENDZIMIR

CÓDIGO	ENVASE EMBALAJE	DESCRIPCIÓN	€/m
080921	30	Mts. tabique separador 30 sendizimir	26,05
080922	30	Mts. tabique separador 60 sendizimir	26,15
080924	30	Mts. tabique separador 110 sendizimir	31,25

TABIQUE SEPARADOR "HR"

CÓDIGO	ENVASE EMBALAJE	DESCRIPCIÓN	€/m
081922	30	Mts. tabique separador 60 HR	28,50
081924	30	Mts. tabique separador 110 HR	36,12

TABIQUE SEPARADOR INOX.

CÓDIGO	ENVASE EMBALAJE	DESCRIPCIÓN	€/m
081926	30	Mts. tabique separador 60 inox.	Consultar
081928	30	Mts. tabique separador 110 inox	Consultar



UNIÓN

UNIONES Y FIJACIONES ZINCADAS

CÓDIGO	ENVASE EMBALAJE	DESCRIPCIÓN	€/ud
075111-Z	50	Brida unión zincada	2,44
075112-Z	50	Brida unión lateral zincada	5,73
075113-Z	50	Brida fijación zincada	1,64



UNIÓN LATERAL

UNIONES Y FIJACIONES GALVANIZADAS CALIENTE

CÓDIGO	ENVASE EMBALAJE	DESCRIPCIÓN	€/ud
075111-G	50	Brida unión galvanizada cal.	3,30
075112-G	50	Brida unión lateral galvanizada cal.	10,66
075113-G	50	Brida fijación galvanizada cal.	2,32



FIJACIÓN

UNIONES Y FIJACIONES INOXIDABLES

CÓDIGO	ENVASE EMBALAJE	DESCRIPCIÓN	€/ud
075111-I	50	Brida unión inoxidable	10,98
075112-I	50	Brida unión lateral inoxidable	17,64
075113-I	50	Brida fijación inoxidable	9,77



SUSPENSIÓN CENTRAL

CÓDIGO	ENVASE EMBALAJE	DESCRIPCIÓN	€/ud
075115-Z	50	Suspensión central zincada	2,15
075115-G	50	Suspensión central galvanizada cal.	2,97
075115-I	50	Suspensión central inoxidable	9,94

Se precisan 2 piezas para realizar una suspensión.



BORNE PUESTA A TIERRA REJILLA

CÓDIGO	ENVASE EMBALAJE	DESCRIPCIÓN	€/ud
075130	25	Borne puesta tierra 10/16	7,20
075131	25	Borne puesta tierra 16/25	10,32
075134	25	Borne puesta tierra 25/35	16,67
075132	25	Borne puesta tierra 35/50	27,50
075133	25	Borne puesta tierra 50/95	39,37

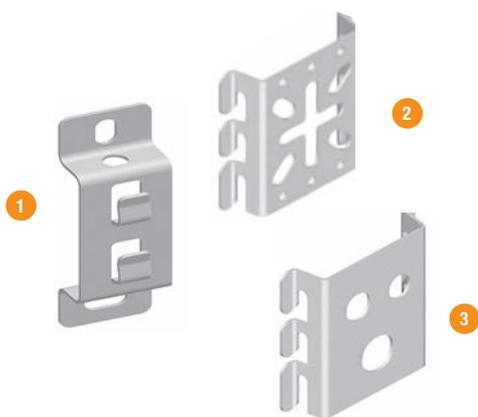

SOPORTES Y ACCESORIOS VARIOS

CÓDIGO	ENVASE EMBALAJE	DESCRIPCIÓN	€/ud
090911	10	Soporte múlt. 60 rápido galv. caliente (1)	4,95
090912	10	Soporte multiuso sendzimir	8,58
090915	10	Soporte multiuso galv. caliente (2)	10,84
090916	10	Soporte multiuso inoxidable	46,20
090918	10	Soporte salidas tubos sendzimir (3)	23,06



FIJACIÓN RÁPIDA REJILLA A PERFIL 21x41 - 41x41

CÓDIGO	ENVASE EMBALAJE	DESCRIPCIÓN	€/ud
075117	100	Fijación rápida rejilla a perfil	4,87



BANDEJA METÁLICA PERFORADA SENDZIMIR

CÓDIGO	ENVASE EMBALAJE	DESCRIPCIÓN	€/m
080101	24	Mts. bandeja metal. perforada 35x100 sendzimir	25,94
080102	12	Mts. bandeja metal. perforada 35x150 sendzimir	31,13
080103	12	Mts. bandeja metal. perforada 35x200 sendzimir	36,44
080104	12	Mts. bandeja metal. perforada 35x300 sendzimir	58,38
080201	24	Mts. bandeja metal. perforada 55x60 sendzimir	26,24
080202	12	Mts. bandeja metal. perforada 60x100 sendzimir	27,30
080203	12	Mts. bandeja metal. perforada 60x150 sendzimir	32,66
080204	12	Mts. bandeja metal. perforada 60x200 sendzimir	38,43
080205	6	Mts. bandeja metal. perforada 60x300 sendzimir	57,53
080206	6	Mts. bandeja metal. perforada 60x400 sendzimir	85,05
080207	6	Mts. bandeja metal. perforada 60x500 sendzimir	107,94
080208	6	Mts. bandeja metal. perforada 60x600 sendzimir	157,13
080401	12	Mts. bandeja metal. perforada 110x100 sendzimir	51,45
080403	6	Mts. bandeja metal. perforada 110x200 sendzimir	63,68
080404	6	Mts. bandeja metal. perforada 110x300 sendzimir	90,30
080405	6	Mts. bandeja metal. perforada 110x400 sendzimir	112,35
080406	6	Mts. bandeja metal. perforada 110x500 sendzimir	163,28
080407	6	Mts. bandeja metal. perforada 110x600 sendzimir	173,78

Altura 85 consultar



BANDEJA METÁLICA CIEGA SENDZIMIR

CÓDIGO	ENVASE EMBALAJE	DESCRIPCIÓN	€/m
080601	24	Mts. bandeja metal. ciega 55x60 sendzimir	26,82
080602	12	Mts. bandeja metal. ciega 60x100 sendzimir	27,30
080603	12	Mts. bandeja metal. ciega 60x150 sendzimir	32,66
080604	12	Mts. bandeja metal. ciega 60x200 sendzimir	38,43
080605	6	Mts. bandeja metal. ciega 60x300 sendzimir	57,53
080606	6	Mts. bandeja metal. ciega 60x400 sendzimir	85,05
080607	6	Mts. bandeja metal. ciega 60x500 sendzimir	107,94
080608	6	Mts. bandeja metal. ciega 60x600 sendzimir	157,13
080801	12	Mts. bandeja metal. ciega 110x100 sendzimir	51,45
080803	6	Mts. bandeja metal. ciega 110x200 sendzimir	63,68
080804	6	Mts. bandeja metal. ciega 110x300 sendzimir	90,30
080805	6	Mts. bandeja metal. ciega 110x400 sendzimir	112,35
080806	6	Mts. bandeja metal. ciega 110x500 sendzimir	163,28
080807	6	Mts. bandeja metal. ciega 110x600 sendzimir	173,78

Altura 85 consultar



BANDEJA METÁLICA PERFORADA "HR"

CÓDIGO	ENVASE EMBALAJE	DESCRIPCIÓN	€/m
081202	12	Mts. bandeja metal. perforada 60x100 HR	47,15
081203	12	Mts. bandeja metal. perforada 60x150 HR	58,67
081204	12	Mts. bandeja metal. perforada 60x200 HR	71,71
081205	6	Mts. bandeja metal. perforada 60x300 HR	93,61
081206	6	Mts. bandeja metal. perforada 60x400 HR	133,3
081207	6	Mts. bandeja metal. perforada 60x500 HR	169,45
081208	6	Mts. bandeja metal. perforada 60x600 HR	250,43
081402	12	Mts. bandeja metal. perforada 110x100 HR	77,70
081403	6	Mts. bandeja metal. perforada 110x200 HR	97,55
081404	6	Mts. bandeja metal. perforada 110x300 HR	145,69
081405	6	Mts. bandeja metal. perforada 110x400 HR	178,90
081406	6	Mts. bandeja metal. perforada 110x500 HR	262,08
081407	6	Mts. bandeja metal. perforada 110x600 HR	290,54

Altura 85 consultar



BANDEJA METÁLICA CIEGA "HR"

CÓDIGO	ENVASE EMBALAJE	DESCRIPCIÓN	€/m
081602	12	Mts. bandeja metal. ciega 60x100 HR	47,15
081603	12	Mts. bandeja metal. ciega 60x150 HR	58,67
081604	12	Mts. bandeja metal. ciega 60x200 HR	71,71
081605	6	Mts. bandeja metal. ciega 60x300 HR	93,61
081606	6	Mts. bandeja metal. ciega 60x400 HR	133,30
081607	6	Mts. bandeja metal. ciega 60x500 HR	169,45
081608	6	Mts. bandeja metal. ciega 60x600 HR	250,43
081801	12	Mts. bandeja metal. ciega 110X100 HR	77,70
081803	6	Mts. bandeja metal. ciega 110x200 HR	97,55
081804	6	Mts. bandeja metal. ciega 110x300 HR	145,69
081805	6	Mts. bandeja metal. ciega 110x400 HR	178,90
081806	6	Mts. bandeja metal. ciega 110x500 HR	262,08
081807	6	Mts. bandeja metal. ciega 110x600 HR	290,54

Altura 85 consultar



TAPA BANDEJA SENDZIMIR

CÓDIGO	ENVASE EMBALAJE	DESCRIPCIÓN	€/m
080901	24	Mts. tapa 60 sendzimir	19,92
080900	24	Mts. tapa 70 sendzimir	21,38
080902	24	Mts. tapa 100 sendzimir	15,77
080903	12	Mts. tapa 150 sendzimir	21,20
080904	12	Mts. tapa 200 sendzimir	25,92
080905	6	Mts. tapa 300 sendzimir	43,97
080906	6	Mts. tapa 400 sendzimir	59,90
080907	6	Mts. tapa 500 sendzimir	84,74
080908	6	Mts. tapa 600 sendzimir	100,36

TAPA BANDEJA "HR"

CÓDIGO	ENVASE EMBALAJE	DESCRIPCIÓN	€/m
081901	24	Mts. tapa 60 HR	28,28
081900	24	Mts. tapa 70 HR	30,59
081902	24	Mts. tapa 100 HR	30,32
081903	12	Mts. tapa 150 HR	42,89
081904	12	Mts. tapa 200 HR	52,81
081905	6	Mts. tapa 300 HR	80,37
081906	6	Mts. tapa 400 HR	111,08
081907	6	Mts. tapa 500 HR	150,66
081908	6	Mts. tapa 600 HR	176,29



TABIQUE SEPARADOR SENDZIMIR

CÓDIGO	ENVASE EMBALAJE	DESCRIPCIÓN	€/m
080921	30	Mts. tabique separador 30 sendzimir	26,05
080922	30	Mts. tabique separador 60 sendzimir	26,15
080924	30	Mts. tabique separador 110 sendzimir	31,25

TABIQUE SEPARADOR "HR"

CÓDIGO	ENVASE EMBALAJE	DESCRIPCIÓN	€/m
081922	30	Mts. tabique separad. 60 HR	28,50
081924	30	Mts. tabique separad. 110 HR	36,12

TORNILLO DE UNIÓN

CÓDIGO	ENVASE EMBALAJE	DESCRIPCIÓN	€/envase
090901	100	Envase 100 tornillo 6x12 c/tuerca Zincado	61,60
090902	100	Envase 100 tornillo 6x12 c/tuerca Galv. caliente	103,24
090909	100	Envase 100 tornillo 6x20 c/tuerca Galv. caliente	129,75
090910	100	Envase 100 tornillo 6x20 c/tuerca Inoxidable	304,32





REFUERZO UNIÓN SENDZIMIR

CÓDIGO	ENVASE EMBALAJE	DESCRIPCIÓN	€/ud
080931	10	Refuerzo unión 35 sendzimir	5,12
080932	10	Refuerzo unión 60 sendzimir	9,90
080934	10	Refuerzo unión 110 sendzimir	20,79

REFUERZO UNIÓN "HR"

CÓDIGO	ENVASE EMBALAJE	DESCRIPCIÓN	€/ud
081932	10	Refuerzo unión 60 HR	19,14
081934	10	Refuerzo unión 110 HR	31,52

ESQUINA Y TAPA 90° SENDZIMIR

CÓDIGO	ENVASE EMBALAJE	DESCRIPCIÓN	€/ud
082101	1	Esquina 90° 35x100 sendzimir	63,97
082102	1	Esquina 90° 35x150 sendzimir	73,21
082103	1	Esquina 90° 35x200 sendzimir	88,63
082104	1	Esquina 90° 35x300 sendzimir	127,69
082112	1	Esquina 90° 60x100 sendzimir	70,02
082113	1	Esquina 90° 60x150 sendzimir	81,68
082114	1	Esquina 90° 60x200 sendzimir	98,67
082115	1	Esquina 90° 60x300 sendzimir	141,37
082116	1	Esquina 90° 60x400 sendzimir	195,94
082117	1	Esquina 90° 60x500 sendzimir	263,53
082118	1	Esquina 90° 60x600 sendzimir	337,40
082131	1	Esquina 90° 110x100 sendzimir	127,33
082133	1	Esquina 90° 110x200 sendzimir	158,68
082134	1	Esquina 90° 110x300 sendzimir	207,52
082135	1	Esquina 90° 110x400 sendzimir	258,80
082136	1	Esquina 90° 110x500 sendzimir	328,63
082137	1	Esquina 90° 110x600 sendzimir	394,09
082142	1	Tapa esquina 90° 100 sendzimir	37,95
082143	1	Tapa esquina 90° 150 sendzimir	50,88
082144	1	Tapa esquina 90° 200 sendzimir	65,18
082145	1	Tapa esquina 90° 300 sendzimir	82,46
082146	1	Tapa esquina 90° 400 sendzimir	127,88
082147	1	Tapa esquina 90° 500 sendzimir	204,75
082148	1	Tapa esquina 90° 600 sendzimir	267,10



DERIVACIÓN Y TAPA SEMI "T" SENDZIMIR

CÓDIGO	ENVASE EMBALAJE	DESCRIPCIÓN	€/ud
082201	1	Derivación semi "T" 35x100 sendzimir	49,12
082202	1	Derivación semi "T" 35x150 sendzimir	52,42
082203	1	Derivación semi "T" 35x200 sendzimir	62,15
082204	1	Derivación semi "T" 35x300 sendzimir	75,79
082212	1	Derivación semi "T" 60x100 sendzimir	61,88
082213	1	Derivación semi "T" 60x150 sendzimir	63,14
082214	1	Derivación semi "T" 60x200 sendzimir	69,03
082215	1	Derivación semi "T" 60x300 sendzimir	71,12
082216	1	Derivación semi "T" 60x400 sendzimir	88,55
082217	1	Derivación semi "T" 60x500 sendzimir	95,70
082218	1	Derivación semi "T" 60x600 sendzimir	106,43
082231	1	Derivación semi "T" 110x100 sendzimir	62,43
082233	1	Derivación semi "T" 110x200 sendzimir	76,07
082234	1	Derivación semi "T" 110x300 sendzimir	88,44
082235	1	Derivación semi "T" 110x400 sendzimir	100,93
082236	1	Derivación semi "T" 110x500 sendzimir	121,28
082237	1	Derivación semi "T" 110x600 sendzimir	125,40
082242	1	Tapa derivación semi "T" 100 sendzimir	33,50
082243	1	Tapa derivación semi "T" 150 sendzimir	37,95
082244	1	Tapa derivación semi "T" 200 sendzimir	42,63
082245	1	Tapa derivación semi "T" 300 sendzimir	51,42
082246	1	Tapa derivación semi "T" 400 sendzimir	60,50
082247	1	Tapa derivación semi "T" 500 sendzimir	69,46
082248	1	Tapa derivación semi "T" 600 sendzimir	78,54

CAMBIO NIVEL Y TAPA CÓNCAVO SENDZIMIR

CÓDIGO	ENVASE EMBALAJE	DESCRIPCIÓN	€/ud
082401	1	Cambio cóncavo 35x100 sendzimir	86,08
082402	1	Cambio cóncavo 35x150 sendzimir	95,87
082403	1	Cambio cóncavo 35x200 sendzimir	105,77
082404	1	Cambio cóncavo 35x300 sendzimir	128,27
082412	1	Cambio cóncavo 60x100 sendzimir	105,31
082413	1	Cambio cóncavo 60x150 sendzimir	119,13
082414	1	Cambio cóncavo 60x200 sendzimir	126,38
082415	1	Cambio cóncavo 60x300 sendzimir	151,53
082416	1	Cambio cóncavo 60x400 sendzimir	174,35
082417	1	Cambio cóncavo 60x500 sendzimir	203,44
082418	1	Cambio cóncavo 60x600 sendzimir	232,16
082431	1	Cambio cóncavo 110x100 sendzimir	163,68
082433	1	Cambio cóncavo 110x200 sendzimir	185,92
082434	1	Cambio cóncavo 110x300 sendzimir	218,47
082435	1	Cambio cóncavo 110x400 sendzimir	236,15
082436	1	Cambio cóncavo 110x500 sendzimir	261,80
082437	1	Cambio cóncavo 110x600 sendzimir	284,66
082442	1	Tapa cambio cóncavo 100 sendzimir	32,34
082443	1	Tapa cambio cóncavo 150 sendzimir	45,65
082444	1	Tapa cambio cóncavo 200 sendzimir	58,97
082445	1	Tapa cambio cóncavo 300 sendzimir	84,15
082446	1	Tapa cambio cóncavo 400 sendzimir	115,19
082447	1	Tapa cambio cóncavo 500 sendzimir	138,81
082448	1	Tapa cambio cóncavo 600 sendzimir	167,34



CAMBIO NIVEL Y TAPA CONVEXO SENDZIMIR

CÓDIGO	ENVASE EMBALAJE	DESCRIPCIÓN	€/ud
082501	1	Cambio convexo 35x100 sendzimir	70,84
082502	1	Cambio convexo 35x150 sendzimir	83,05
082503	1	Cambio convexo 35x200 sendzimir	95,43
082504	1	Cambio convexo 35x300 sendzimir	106,98
082512	1	Cambio convexo 60x100 sendzimir	77,28
082513	1	Cambio convexo 60x150 sendzimir	89,65
082514	1	Cambio convexo 60x200 sendzimir	101,75
082515	1	Cambio convexo 60x300 sendzimir	110,28
082516	1	Cambio convexo 60x400 sendzimir	131,62
082517	1	Cambio convexo 60x500 sendzimir	153,07
082518	1	Cambio convexo 60x600 sendzimir	174,35
082531	1	Cambio convexo 110x100 sendzimir	91,19
082533	1	Cambio convexo 110x200 sendzimir	114,84
082534	1	Cambio convexo 110x300 sendzimir	129,14
082535	1	Cambio convexo 110x400 sendzimir	161,98
082536	1	Cambio convexo 110x500 sendzimir	173,98
082537	1	Cambio convexo 110x600 sendzimir	182,49
082542	1	Tapa cambio convexo 100 sendzimir	38,50
082543	1	Tapa cambio convexo 150 sendzimir	48,68
082544	1	Tapa cambio convexo 200 sendzimir	65,89
082545	1	Tapa cambio convexo 300 sendzimir	88,72
082546	1	Tapa cambio convexo 400 sendzimir	111,54
082547	1	Tapa cambio convexo 500 sendzimir	135,19
082548	1	Tapa cambio convexo 600 sendzimir	164,61

TAPA FINAL - REDUCCIÓN SENDZIMIR

CÓDIGO	ENVASE EMBALAJE	DESCRIPCIÓN	€/ud
082611	1	Tapa final-reducción 60x50 sendzimir	28,88
082612	1	Tapa final-reducción 60x100 sendzimir	34,27
082613	1	Tapa final-reducción 60x150 sendzimir	44,44
082614	1	Tapa final-reducción 60x200 sendzimir	50,05
082615	1	Tapa final-reducción 60x300 sendzimir	65,18
082616	1	Tapa final-reducción 60x400 sendzimir	74,97
082617	1	Tapa final-reducción 60x500 sendzimir	100,93
082618	1	Tapa final-reducción 60x600 sendzimir	114,29
082631	1	Tapa final-reducción 110x50 sendzimir	40,32
082632	1	Tapa final-reducción 110x100 sendzimir	51,32
082634	1	Tapa final-reducción 110x200 sendzimir	73,15
082635	1	Tapa final-reducción 110x300 sendzimir	95,15
082636	1	Tapa final-reducción 110x400 sendzimir	116,88
082637	1	Tapa final-reducción 110x500 sendzimir	160,77
082638	1	Tapa final-reducción 110x600 sendzimir	182,60





ESQUINA Y TAPA DE 90° "HR"

CÓDIGO	ENVASE EMBALAJE	DESCRIPCIÓN	€/ud
083112	1	Esquina 90° 60x100 HR	101,41
083113	1	Esquina 90° 60x150 HR	115,65
083114	1	Esquina 90° 60x200 HR	141,01
083115	1	Esquina 90° 60x300 HR	204,23
083116	1	Esquina 90° 60x400 HR	290,56
083117	1	Esquina 90° 60x500 HR	395,86
083118	1	Esquina 90° 60x600 HR	502,11
083131	1	Esquina 90° 110x100 HR	152,74
083133	1	Esquina 90° 110x200 HR	187,66
083134	1	Esquina 90° 110x300 HR	266,37
083135	1	Esquina 90° 110x400 HR	359,33
083136	1	Esquina 90° 110x500 HR	471,71
083137	1	Esquina 90° 110x600 HR	598,06
083142	1	Tapa Esquina 90° 100 HR	59,86
083143	1	Tapa Esquina 90° 150 HR	71,79
083144	1	Tapa Esquina 90° 200 HR	93,79
083145	1	Tapa Esquina 90° 300 HR	121,07
083146	1	Tapa Esquina 90° 400 HR	195,94
083147	1	Tapa Esquina 90° 500 HR	279,33
083148	1	Tapa Esquina 90° 600 HR	376,17



DERIVACIÓN Y TAPA SEMI T "HR"

CÓDIGO	ENVASE EMBALAJE	DESCRIPCIÓN	€/ud
083212	1	Derivación semi "T" 60x100 HR	78,33
083213	1	Derivación semi "T" 60x150 HR	84,86
083214	1	Derivación semi "T" 60x200 HR	92,26
083215	1	Derivación semi "T" 60x300 HR	108,42
083216	1	Derivación semi "T" 60x400 HR	123,81
083217	1	Derivación semi "T" 60x500 HR	144,30
083218	1	Derivación semi "T" 60x600 HR	155,69
083231	1	Derivación semi "T" 110x100 HR	76,00
083233	1	Derivación semi "T" 110x200 HR	102,59
083234	1	Derivación semi "T" 110x300 HR	116,78
083235	1	Derivación semi "T" 110x400 HR	125,88
083236	1	Derivación semi "T" 110x500 HR	139,69
083237	1	Derivación semi "T" 110x600 HR	153,12
083242	1	Tapa derivación semi "T" 100 HR	34,33
083243	1	Tapa derivación semi "T" 150 HR	39,07
083244	1	Tapa derivación semi "T" 200 HR	43,10
083245	1	Tapa derivación semi "T" 300 HR	56,65
083246	1	Tapa derivación semi "T" 400 HR	71,53
083247	1	Tapa derivación semi "T" 500 HR	85,08
083248	1	Tapa derivación semi "T" 600 HR	98,64

CAMBIO NIVEL Y TAPA CÓNCAVO "HR"

CÓDIGO	ENVASE EMBALAJE	DESCRIPCIÓN	€/ud
083412	1	Cambio cóncavo 60x100 HR	145,62
083413	1	Cambio cóncavo 60x150 HR	163,05
083414	1	Cambio cóncavo 60x200 HR	178,56
083415	1	Cambio cóncavo 60x300 HR	214,20
083416	1	Cambio cóncavo 60x400 HR	251,37
083417	1	Cambio cóncavo 60x500 HR	287,55
083418	1	Cambio cóncavo 60x600 HR	319,72
083431	1	Cambio cóncavo 110x100 HR	204,43
083433	1	Cambio cóncavo 110x200 HR	244,76
083434	1	Cambio cóncavo 110x300 HR	285,43
083435	1	Cambio cóncavo 110x400 HR	323,14
083436	1	Cambio cóncavo 110x500 HR	365,57
083437	1	Cambio cóncavo 110x600 HR	407,27
083442	1	Tapa cambio cóncavo 100 HR	46,75
083443	1	Tapa cambio cóncavo 150 HR	57,30
083444	1	Tapa cambio cóncavo 200 HR	77,77
083445	1	Tapa cambio cóncavo 300 HR	107,03
083446	1	Tapa cambio cóncavo 400 HR	147,32
083447	1	Tapa cambio cóncavo 500 HR	178,15
083448	1	Tapa cambio cóncavo 600 HR	210,54

**CAMBIO NIVEL Y TAPA CONVEXO "HR"**

CÓDIGO	ENVASE EMBALAJE	DESCRIPCIÓN	€/ud
083512	1	Cambio convexo 60x100 HR	100,07
083513	1	Cambio convexo 60x150 HR	114,84
083514	1	Cambio convexo 60x200 HR	130,43
083515	1	Cambio convexo 60x300 HR	150,51
083516	1	Cambio convexo 60x400 HR	178,61
083517	1	Cambio convexo 60x500 HR	207,04
083518	1	Cambio convexo 60x600 HR	235,14
083531	1	Cambio convexo 110x100 HR	119,35
083533	1	Cambio convexo 110x200 HR	139,52
083534	1	Cambio convexo 110x300 HR	163,81
083535	1	Cambio convexo 110x400 HR	187,23
083536	1	Cambio convexo 110x500 HR	212,34
083537	1	Cambio convexo 110x600 HR	236,08
083542	1	Tapa cambio convexo 100 HR	70,73
083543	1	Tapa cambio convexo 150 HR	61,52
083544	1	Tapa cambio convexo 200 HR	87,45
083545	1	Tapa cambio convexo 300 HR	119,65
083546	1	Tapa cambio convexo 400 HR	153,04
083547	1	Tapa cambio convexo 500 HR	185,56
083548	1	Tapa cambio convexo 600 HR	219,07





TAPA FINAL - REDUCCIÓN "HR"

CÓDIGO	ENVASE EMBALAJE	DESCRIPCIÓN	€/ud
083611	1	Tapa final-reducción 60x50 HR	31,90
083612	1	Tapa final-reducción 60x100 HR	40,98
083613	1	Tapa final-reducción 60x150 HR	50,77
083614	1	Tapa final-reducción 60x200 HR	59,40
083615	1	Tapa final-reducción 60x300 HR	81,68
083616	1	Tapa final-reducción 60x400 HR	108,90
083617	1	Tapa final-reducción 60x500 HR	140,69
083618	1	Tapa final-reducción 60x600 HR	167,09
083631	1	Tapa final-reducción 110x50 HR	46,64
083632	1	Tapa final-reducción 110x100 HR	53,52
083633	1	Tapa final-reducción 110x150 HR	68,64
083634	1	Tapa final-reducción 110x200 HR	89,82
083635	1	Tapa final-reducción 110x300 HR	125,13
083636	1	Tapa final-reducción 110x400 HR	146,74
083637	1	Tapa final-reducción 110x500 HR	169,40
083638	1	Tapa final-reducción 110x600 HR	207,35

SOPORTES



PERFIL OMEGA REFORZADO COLGANTE SENDZIMIR

CÓDIGO	ENVASE EMBALAJE	DESCRIPCIÓN	€/ud
090320	10	Perfil omega ref. colgante 460 sendzimir	26,15
090321	10	Perfil omega ref. colgante 560 sendzimir	27,62
090322	10	Perfil omega ref. colgante 660 sendzimir	31,32

PERFIL OMEGA REF. COLGANTE "HR"

CÓDIGO	ENVASE EMBALAJE	DESCRIPCIÓN	€/ud
090330	10	Perfil omega ref. 460 HR	35,54
090331	10	Perfil omega ref. 560 HR	41,67
090332	10	Perfil omega ref. 660 HR	47,82



SOPORTE OMEGA REFORZADO SENDZIMIR

CÓDIGO	ENVASE EMBALAJE	DESCRIPCIÓN	€/ud
090120	10	Soporte omega 100 reforzado sendzimir	11,76
090121	10	Soporte omega 150 reforzado sendzimir	13,76
090122	10	Soporte omega 200 reforzado sendzimir	15,65
090123	10	Soporte omega 300 reforzado sendzimir	18,74
090124	10	Soporte omega 400 reforzado sendzimir	22,21
090125	10	Soporte omega 500 reforzado sendzimir	23,38
090126	10	Soporte omega 600 reforzado sendzimir	26,44



SOPORTE OMEGA REFORZADO "HR"

CÓDIGO	ENVASE EMBALAJE	DESCRIPCIÓN	€/ud
090140	10	Soporte omega 100 reforz. HR	16,28
090141	10	Soporte omega 150 reforz. HR	22,63
090142	10	Soporte omega 200 reforz. HR	25,36
090143	10	Soporte omega 300 reforz. HR	30,40
090144	10	Soporte omega 400 reforz. HR	37,91
090145	10	Soporte omega 500 reforz. HR	40,37
090146	10	Soporte omega 600 reforz. HR	44,94



SOPORTE TECHO OMEGA SENDZIMIR

CÓDIGO	ENVASE EMBALAJE	DESCRIPCIÓN	€/ud
090410	20	Soporte techo omega 100 sendzimir	19,11
090411	15	Soporte techo omega 150 sendzimir	21,63
090412	12	Soporte techo omega 200 sendzimir	23,44
090413	12	Soporte techo omega 300 sendzimir	26,68
090414	12	Soporte techo omega 400 sendzimir	30,98



SOPORTE TECHO OMEGA "HR"

CÓDIGO	ENVASE EMBALAJE	DESCRIPCIÓN	€/ud
090430	20	Soporte techo omega 100 HR	28,82
090431	15	Soporte techo omega 150 HR	32,78
090432	12	Soporte techo omega 200 HR	34,76
090433	12	Soporte techo omega 300 HR	40,92
090434	12	Soporte techo omega 400 HR	47,08



SOPORTE HORIZONTAL SENDZIMIR

CÓDIGO	ENVASE EMBALAJE	DESCRIPCIÓN	€/ud
090210	10	Soporte horizontal 100 sendzimir	9,82
090211	10	Soporte horizontal 150 sendzimir	15,05
090212	10	Soporte horizontal 200 sendzimir	20,13
090213	10	Soporte horizontal 300 sendzimir	35,60
090214	5	Soporte horizontal 400 sendzimir	42,80
090215	5	Soporte horizontal 500 sendzimir	60,78
090216	5	Soporte horizontal 600 sendzimir	67,97



SOPORTE HORIZONTAL GALV. CALIENTE

CÓDIGO	ENVASE EMBALAJE	DESCRIPCIÓN	€/ud
090230	10	Soporte horizontal 100 Galv. caliente	20,87
090231	10	Soporte horizontal 150 Galv. caliente	24,93
090232	10	Soporte horizontal 200 Galv. caliente	29,16
090233	10	Soporte horizontal 300 Galv. caliente	45,56
090234	5	Soporte horizontal 400 Galv. caliente	72,66
090235	5	Soporte horizontal 500 Galv. caliente	90,39
090236	5	Soporte horizontal 600 Galv. caliente	103,39



SOPORTE HORIZONTAL INOXIDABLE

CÓDIGO	ENVASE EMBALAJE	DESCRIPCIÓN	€/ud
090240	10	Soporte horizontal 100 inox.	45,89
090241	10	Soporte horizontal 150 inox.	50,51
090242	10	Soporte horizontal 200 inox.	56,65
090243	10	Soporte horizontal 300 inox.	75,97
090244	5	Soporte horizontal 400 inox.	113,74
090245	5	Soporte horizontal 500 inox.	146,85
090246	5	Soporte horizontal 600 inox.	172,70

SOPORTE GRANDES CARGAS SENDZIMIR

CÓDIGO	ENVASE EMBALAJE	DESCRIPCIÓN	€/ud
091111	1	Soporte horiz. reforz. 2/200 sendzimir	33,00
091112	1	Soporte horiz. reforz. 2/300 sendzimir	42,79
091113	1	Soporte horiz. reforz. 2/400 sendzimir	52,69
091114	1	Soporte horiz. reforz. 2/600 sendzimir	73,92
091115	1	Soporte horiz. reforz. 2/1000 sendzimir	122,14
091122	1	Soporte horiz. reforz. 2,5/200 sendzimir	42,16
091123	1	Soporte horiz. reforz. 2,5/300 sendzimir	64,23
091124	1	Soporte horiz. reforz. 2,5/400 sendzimir	72,05
091126	1	Soporte horiz. reforz. 2,5/600 sendzimir	101,01
091128	1	Soporte horiz. reforz. 2,5/1000 sendzimir	183,36





RAIL SUSPENSIÓN SENDZIMIR

CÓDIGO	ENVASE EMBALAJE	DESCRIPCIÓN	€/ud
090801	10	Raíl suspensión 100 sendzimir	7,88
090802	10	Raíl suspensión 200 sendzimir	11,03
090803	10	Raíl suspensión 300 sendzimir	14,23
090804	10	Raíl suspensión 400 sendzimir	17,75
090805	10	Raíl suspensión 500 sendzimir	20,79
090806	10	Raíl suspensión 600 sendzimir	24,41

RAIL SUSPENSIÓN "HR"

CÓDIGO	ENVASE EMBALAJE	DESCRIPCIÓN	€/ud
090822	10	Raíl suspensión 200 HR	18,77
090823	10	Raíl suspensión 300 HR	23,73
090824	10	Raíl suspensión 400 HR	30,67
090825	10	Raíl suspensión 500 HR	38,81
090826	10	Raíl suspensión 600 HR	44,24



SOPORTE DISTANCIADOR SENDZIMIR

CÓDIGO	ENVASE EMBALAJE	DESCRIPCIÓN	€/ud
091010	10	Soporte distanciador de 100 sendzimir	10,84
091011	10	Soporte distanciador de 150 sendzimir	12,86
091012	10	Soporte distanciador de 200 sendzimir	14,91
091013	10	Soporte distanciador de 300 sendzimir	19,36
091014	10	Soporte distanciador de 400 sendzimir	31,90
091015	10	Soporte distanciador de 500 sendzimir	35,81
091016	10	Soporte distanciador de 600 sendzimir	47,58

SOPORTE DISTANCIADOR "HR"

CÓDIGO	ENVASE EMBALAJE	DESCRIPCIÓN	€/ud
091020	10	Soporte distanciador de 100 HR	15,62
091021	10	Soporte distanciador de 150 HR	18,10
091022	10	Soporte distanciador de 200 HR	21,07
091023	10	Soporte distanciador de 300 HR	26,51
091024	10	Soporte distanciador de 400 HR	41,03
091025	10	Soporte distanciador de 500 HR	49,50
091026	10	Soporte distanciador de 600 HR	70,24



SOPORTE DISTANCIADOR INOXIDABLE

CÓDIGO	ENVASE EMBALAJE	DESCRIPCIÓN	€/ud
091040	10	Soporte distanciador de 100 inox.	59,02
091041	10	Soporte distanciador de 150 inox.	70,95
091042	10	Soporte distanciador de 200 inox.	78,38
091043	10	Soporte distanciador de 300 inox.	86,96
091044	10	Soporte distanciador de 400 inox.	106,70
091045	10	Soporte distanciador de 500 inox.	117,43
091046	10	Soporte distanciador de 600 inox.	132,22



SOPORTE BASCULANTE PERFIL REFORZADO

CÓDIGO	ENVASE EMBALAJE	DESCRIPCIÓN	€/ud
090340	10	Soporte basculante SPER sendimir	44,46
090341	10	Soporte basculante SPER galv. cal.	56,39

Perfiles para soporte basculante

- 270411 Perfil C 41 x 41 ref. troquelado sendimir
- 270502 Perfil C 41 x 41 ref. troquelado HR

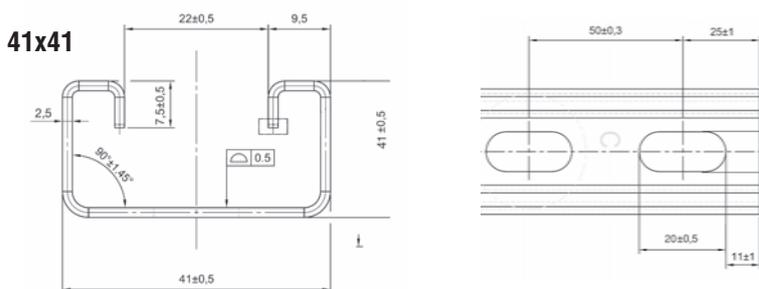

SOPORTE "C" Y CONJUNTO VARILLA ROSCADA

CÓDIGO	ENVASE EMBALAJE	DESCRIPCIÓN	€/ud
090913	10	Soporte "C"	7,15
090904	10	Varilla roscada M6 c/ tuercas y arandelas	10,29
090905	10	Varilla roscada M8 c/ tuercas y arandelas	14,91
090906	10	Varilla roscada M10 c/ tuercas y arandela	19,65

Conjunto varilla contiene el juego de tuercas y arandelas.

CONECTORES PARA VARILLAS

CÓDIGO	ENVASE EMBALAJE	DESCRIPCIÓN	€/envase
200752	100	Envase 100 conectores varilla M6x30	49,22
200753	100	Envase 100 conectores varilla M8x30	56,84
200754	100	Envase 100 conectores varilla M10x30	80,04

TACOS PARA VARILLAS

CÓDIGO	ENVASE EMBALAJE	DESCRIPCIÓN	€/envase
130802	100	Envase 100 tacos hembra M6	25,41
130803	100	Envase 100 tacos hembra M8	35,57
130804	100	Envase 100 tacos hembra M10	59,71
130812	1	Retacador M6	10,16
130813	1	Retacador M8	11,80
130814	1	Retacador M10	13,28





SOPORTES FIJACIÓN RÁPIDA A VARILLA

CÓDIGO	ENVASE EMBALAJE	DESCRIPCIÓN	€/ud
090921	100	Soporte universal a varilla M4/8	6,55
090922	100	Soporte universal a varilla M8/12	6,65
090923	50	Soporte bandeja a varilla M4/8	30,04
090924	50	Soporte bandeja a varilla M8/12	35,04

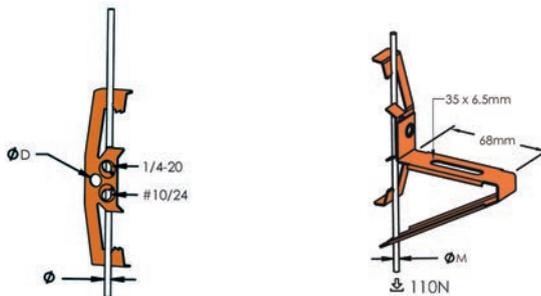

1

SISTEMAS CONTRA EL FUEGO

CÓDIGO	ENVASE EMBALAJE	DESCRIPCIÓN	€/ud
091180	1	Saquito intumescente 120x200x30 (1)	157,50
091181	1	Saquito intumescente 120x250x35 (1)	247,50
091182	1	Saquito intumescente 120x300x35 (1)	319,50
091183	1	Rejilla intumescente 150x150 (2)	945,70
091184	1	Rejilla intumescente 150x300 (2)	1.519,00
091185	1	Rejilla intumescente 200x200 (2)	1.205,40
091186	1	Rejilla intumescente 200x400 (2)	1.984,50
091187	1	Rejilla intumescente 300x300 (2)	2.018,80
091188	1	Rejilla intumescente 300x400 (2)	2.621,50
091189	1	Rejilla intumescente 400x400 (2)	3.248,70



2

(1) Rellenos de material intumescente termo expansivo para sellar huecos de paso en bandejas de cables y tuberías impidiendo la propagación de humos y fuego.

(2) Según norma UNE EN 1364-5: 2017

Rejillas de material intumescente que en caso de incendio, a partir de 120° C necesita menos de 5 minutos para realizar el cierre completo de los espacios entre láminas, impidiendo el paso de humos y fuego.

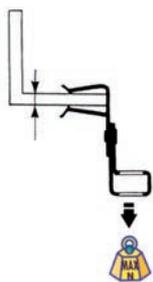

GRAPA HORIZONTAL

CÓDIGO	ENVASE EMBALAJE	DESCRIPCIÓN	MAX. N	€/ud
130302	25	Grapa horizontal viga 3/8 - varilla M6	900	5,40
130303	25	Grapa horizontal viga 8/14 - varilla M6	900	5,70
130306	25	Grapa horizontal viga 3/8 - varilla M8	900	5,40
130307	25	Grapa horizontal viga 8/14 - varilla M8	900	5,70
130310	25	Grapa horizontal viga 3/8 - varilla M10	900	5,40
130311	25	Grapa horizontal viga 8/14 - varilla M10	900	5,70

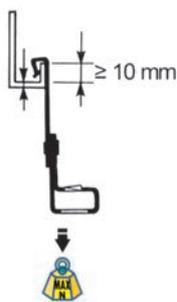

GRAPA VERTICAL

CÓDIGO	ENVASE EMBALAJE	DESCRIPCIÓN	MAX. N	€/ud
130321	25	Grapa vertical viga 1,5/4 - varilla M6	700	6,04
130322	25	Grapa vertical viga 1,5/4 - varilla M8	700	6,04
130323	25	Grapa vertical viga 1,5/4 - varilla M10	700	6,04
130324	25	Grapa vertical viga 4/6,5 - varilla M6	700	6,04
130325	25	Grapa vertical viga 4/6,5 - varilla M8	700	6,04
130326	25	Grapa vertical viga 4/6,5 - varilla M10	700	6,04

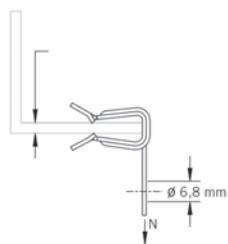

GRAPA HORIZONTAL PARA COLGAR

CÓDIGO	ENVASE EMBALAJE	DESCRIPCIÓN	MAX. N	€/ud
130331	25	Grapa horizontal colgar viga 2/3	700	2,67
130332	25	Grapa horizontal colgar viga 3/8	900	2,97
130333	25	Grapa horizontal colgar viga 8/14	900	3,27
130334	25	Grapa horizontal colgar viga 14/20	900	3,47

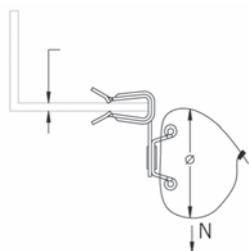

GRAPA HORIZONTAL PARA BRIDAS

CÓDIGO	ENVASE EMBALAJE	DESCRIPCIÓN	MAX. N	€/ud
130335	25	Grapa horizontal bridas viga 2/3	150	5,91
130336	25	Grapa horizontal bridas viga 3/8	150	6,26
130337	25	Grapa horizontal bridas viga 8/14	150	6,48
130338	25	Grapa horizontal bridas viga 14/20	150	6,73

Válidas para bridas hasta 9 mm. ancho.

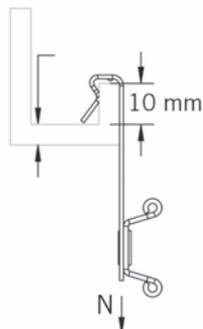

GRAPA VERTICAL PARA BRIDAS

CÓDIGO	ENVASE EMBALAJE	DESCRIPCIÓN	MAX. N	€/ud
130339	25	Grapa vertical bridas viga 1,5/4	150	6,25
130340	25	Grapa vertical bridas viga 4/6,5	150	6,35

Válidas para bridas hasta 9 mm. ancho.

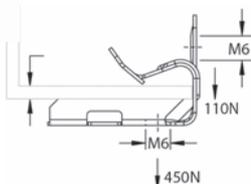

GRAPA HORIZONTAL MÚLTIPLE

CÓDIGO	ENVASE EMBALAJE	DESCRIPCIÓN	MAX. N	€/ud
130341	25	Grapa horizontal múltiple viga 3/8	*	4,07
130342	25	Grapa horizontal múltiple viga 8/14	*	4,46
130343	25	Grapa horizontal múltiple viga 14/20	*	4,83

* Ver dibujos cotas.

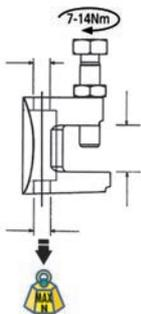

GRAPAS FIJACIÓN VIGA

CÓDIGO	ENVASE EMBALAJE	DESCRIPCIÓN	MAX. N	€/ud
130521	10	Fijación tornillo viga 18mm-ø 9	1200	10,72
130522	10	Fijación tornillo viga 20mm-ø 11	2500	11,12
130523	10	Fijación tornillo viga 26mm-ø 13	3500	12,72
130527	10	Fijación tornillo viga 18mm-M6	1200	9,85
130524	10	Fijación tornillo viga 18mm-M8	1200	10,72
130525	10	Fijación tornillo viga 20mm-M10	2500	11,12
130526	10	Fijación tornillo viga 26mm-M12	3500	12,72

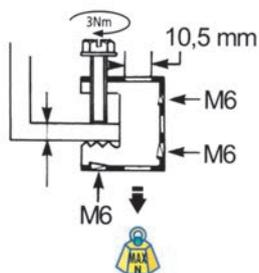

GRAPA MULTIFUNCIÓN

CÓDIGO	ENVASE EMBALAJE	DESCRIPCIÓN	MAX. N	€/ud
130530	10	Fijación tornillo viga multifunción		8,76

Pieza para sujeción de cajas y otros elementos.

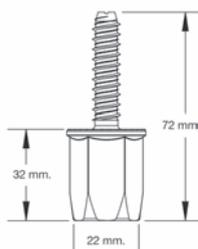

GRAPA TORNILLO VIGA FIJACIÓN RÁPIDA

CÓDIGO	ENVASE EMBALAJE	DESCRIPCIÓN	€/ud
130551	10	Grapa tornillo viga fij. rápida 3/10mm M8 (1)	12,87
130552	10	Grapa tornillo viga fij. rápida 3/10mm M10 (1)	13,66
130553	10	Grapa tornillo viga fij. rápida 9.5/20mm M12 (2)	17,87

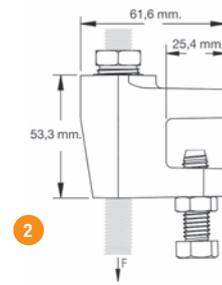
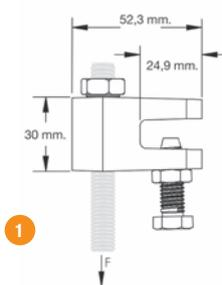

TORNILLO ANCLAJE FIJACIÓN RÁPIDA

CÓDIGO	ENVASE EMBALAJE	DESCRIPCIÓN	€/ud
130555	10	Tornillo anclaje fij. rápida M8	7,70
130556	10	Tornillo anclaje fij. rápida M10	8,20



TUERCA PERFIL FIJACIÓN RÁPIDA

CÓDIGO	ENVASE EMBALAJE	DESCRIPCIÓN	€/ud
130557	10	Tuerca perfil fij. rápida M8	10,45
130558	10	Tuerca perfil fij. rápida M10	11,04



TUERCA FIJACIÓN RÁPIDA

CÓDIGO	ENVASE EMBALAJE	DESCRIPCIÓN	€/ud
130561	25	Tuerca fijación rápida M6	4,85
130562	25	Tuerca fijación rápida M8	5,89
130563	25	Tuerca fijación rápida M10	6,39
130564	25	Tuerca fijación rápida M12	7,35

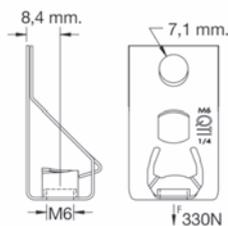

GRAPA RECTA FIJACIÓN RÁPIDA

CÓDIGO	ENVASE EMBALAJE	DESCRIPCIÓN	MAX. N	€/ud
130565	100	Grapa recta fij. rápida	330N	2,40

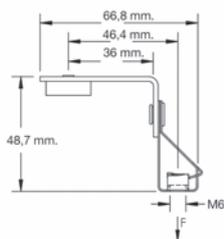

GRAPA ESCUADRA FIJACIÓN RÁPIDA

CÓDIGO	ENVASE EMBALAJE	DESCRIPCIÓN	MAX. N	€/ud
130566	100	Grapa escuadra fij. rápida	330N	7,60



GRAPA VERTICAL FIJACIÓN RÁPIDA

CÓDIGO	ENVASE EMBALAJE	DESCRIPCIÓN	MAX. N	€/ud
130567	100	Grapa vertical fij. rápida 1,5 - 4	330N	6,28
130568	100	Grapa vertical fij. rápida 4 - 6,5	330N	6,28

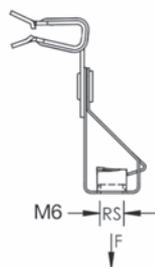

GRAPA HORIZONTAL FIJACIÓN RÁPIDA

CÓDIGO	ENVASE EMBALAJE	DESCRIPCIÓN	MAX. N	€/ud
130569	100	Grapa horizontal fij. rápida 2 - 3	330N	5,42
130570	100	Grapa horizontal fij. rápida 3 - 8	330N	5,60
130571	100	Grapa horizontal fij. rápida 8 - 14	330N	5,86
130572	100	Grapa horizontal fij. rápida 14 - 20	330N	6,03

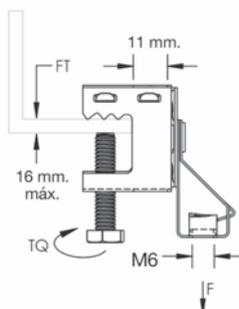

GRAPA MULTIFUNCIÓN FIJACIÓN RÁPIDA

CÓDIGO	ENVASE EMBALAJE	DESCRIPCIÓN	MAX. N	€/ud
130563	100	Grapa Multifunción fij. rápida	330N	9,23



SUSPENSIÓN ACERO

CÓDIGO	ENVASE EMBALAJE	DESCRIPCIÓN	€/ud
130102	20	Suspensión acero 1,5 mm. - 2 metros	11,78
130103	20	Suspensión acero 1,5 mm. - 3 metros	13,05
130105	20	Suspensión acero 1,5 mm. - 5 metros	15,23
130202	10	Suspensión acero 2 mm. - 2 metros	14,55
130203	10	Suspensión acero 2 mm. - 3 metros	16,35
130205	10	Suspensión acero 2 mm. - 5 metros	20,78



DISPOSITIVOS BLOQUEO

CÓDIGO	ENVASE EMBALAJE	DESCRIPCIÓN	€/ud
130250	200	Dispositivo bloqueo hexagonal (1)	7,35
130251	200	Dispositivo bloqueo 1,5/2 mm. (2)	7,50
130252	200	Dispositivo bloqueo 3 mm. (2)	7,92

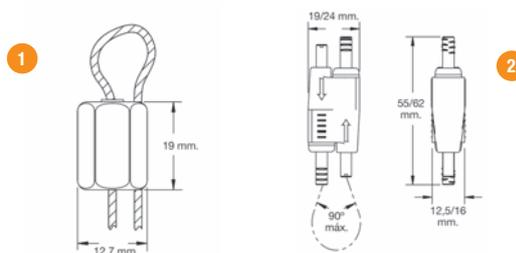

DISPOSITIVO BLOQUEO SUSPENSIÓN

CÓDIGO	ENVASE EMBALAJE	DESCRIPCIÓN	€/ud
130253	200	Dispositivo bloqueo suspensión 2/8 (1)	7,50
130254	200	Dispositivo bloqueo suspensión 3/12 (2)	7,75

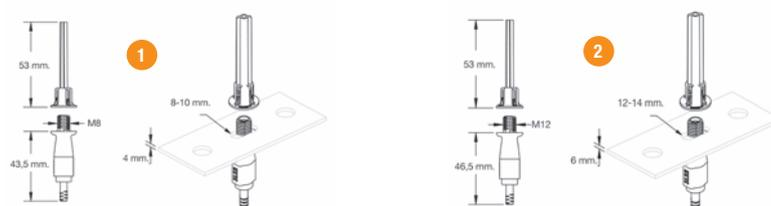



CARRETE CABLE ACERO

CÓDIGO	ENVASE EMBALAJE	DESCRIPCIÓN	€/ud
130255	1	Carrete cable acero 1,5 mm. 50 metros	53,58
130256	1	Carrete cable acero 1,5 mm. 300 metros	170,35
130258	1	Carrete cable acero 2 mm. 300 metros	182,97
130260	1	Carrete cable acero 3 mm. 300 metros	311,47



KIT CABLE + BLOQUEOS

CÓDIGO	ENVASE EMBALAJE	DESCRIPCIÓN	€/ud
130261	1	Kit cable 1,5 + bloqueo 150 metros	701,06
130263	1	Kit cable 2 + bloqueo 100 metros	469,99
130264	1	Kit cable 1,5 + bloqueo + herramienta 100 metros	774,00



HERRAMIENTA CORTACABLE

CÓDIGO	ENVASE EMBALAJE	DESCRIPCIÓN	€/ud
130268	1	Herramienta cortacable	143,44



ELEMENTOS SUSPENSIÓN

CÓDIGO	ENVASE EMBALAJE	DESCRIPCIÓN	€/ud
130265	100	Soporte fijación para Conductos (1)	0,87
130266	200	Clip fijación pantallas (2)	1,33



TORNILLO FIJACIÓN HORMIGÓN

CÓDIGO	ENVASE EMBALAJE	DESCRIPCIÓN	€/ud
130281	100	Tornillo fijación hormigón M5x65	1,29

Elemento para la suspensión de pantallas, luminarias, tuberías y otros elementos.

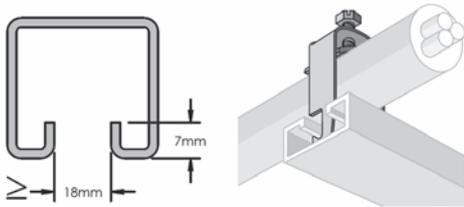

GRAPA FIJACIÓN TUBOS Y CABLES A REJILLAS Y PERFILES 21 Y 41

CÓDIGO	ENVASE EMBALAJE	DESCRIPCIÓN	€/ud
130501	100	Grapa fijación TC-6/12	3,38
130502	100	Grapa fijación TC-12/16	3,43
130503	100	Grapa fijación TC-16/20	3,69
130504	100	Grapa fijación TC-20/24	3,94
130505	100	Grapa fijación TC-24/28	4,41
130506	100	Grapa fijación TC-28/32	4,79
130507	100	Grapa fijación TC-32/36	5,23
130508	100	Grapa fijación TC-36/40	6,17
130509	100	Grapa fijación TC-40/44	6,69
130510	100	Grapa fijación TC-44/48	7,09
130511	50	Grapa fijación TC-48/52	7,31
130512	50	Grapa fijación TC-52/56	8,14
130513	50	Grapa fijación TC-56/60	8,30

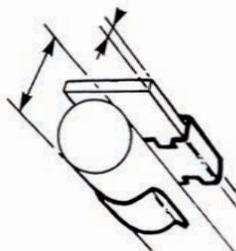

FIJACIONES "C" PARA TUBOS A VIGA

CÓDIGO	ENVASE EMBALAJE	DESCRIPCIÓN	€/ud
130401	100	Fijación "C" viga 2/4 diámetro 6-7	0,54
130402	100	Fijación "C" viga 2/4 diámetro 7-8	0,54
130403	100	Fijación "C" viga 2/4 diámetro 8-9	0,54
130404	100	Fijación "C" viga 2/4 diámetro 9-10	0,54
130405	100	Fijación "C" viga 2/4 diámetro 10-11	0,57
130406	100	Fijación "C" viga 2/4 diámetro 12-14	0,57
130407	100	Fijación "C" viga 2/4 diámetro 15-18	0,66
130408	100	Fijación "C" viga 2/4 diámetro 19-24	0,86
130409	100	Fijación "C" viga 2/4 diámetro 25-32	1,03
130411	100	Fijación "C" viga 4/7 diámetro 6-7	0,54
130412	100	Fijación "C" viga 4/7 diámetro 7-8	0,54
130413	100	Fijación "C" viga 4/7 diámetro 8-9	0,54
130414	100	Fijación "C" viga 4/7 diámetro 9-10	0,54
130415	100	Fijación "C" viga 4/7 diámetro 10-11	0,57
130416	100	Fijación "C" viga 4/7 diámetro 12-14	0,57
130417	100	Fijación "C" viga 4/7 diámetro 15-18	0,66
130418	100	Fijación "C" viga 4/7 diámetro 19-24	0,86
130419	100	Fijación "C" viga 4/7 diámetro 25-32	1,03
130421	100	Fijación "C" viga 8/12 diámetro 6-7	0,54
130422	100	Fijación "C" viga 8/12 diámetro 7-8	0,54
130423	100	Fijación "C" viga 8/12 diámetro 8-9	0,54
130424	100	Fijación "C" viga 8/12 diámetro 9-10	0,54
130425	100	Fijación "C" viga 8/12 diámetro 10-11	0,57
130426	100	Fijación "C" viga 8/12 diámetro 12-14	0,57
130427	100	Fijación "C" viga 8/12 diámetro 15-18	0,66
130428	100	Fijación "C" viga 8/12 diámetro 19-24	0,86
130429	100	Fijación "C" viga 8/12 diámetro 25-32	1,03

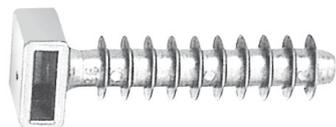

TACOS Y SOPORTES PARA BRIDAS

CÓDIGO	ENVASE EMBALAJE	DESCRIPCIÓN	€/envase
101203	100/5000	Envase 100 tacos 8 mm. planos negros	(1) 13,36
101204	100/1000	Envase 100 tacos 8 mm. altos negros	13,36
101202	100/1000	Envase 100 tacos G8 planos grises	13,36
101207	100/1000	Envase 100 tacos B8 planos blanco	15,28
101205	100/2000	Envase 100 tacos 8 mm. cabeza roscante negros	(2) 14,31
101206	100/2000	Envase 100 tacos 8 mm. cabeza roscante grises	14,31
101212	100/5000	Envase 100 soportes roscado negro	(3) 12,07
101213	100/5000	Envase 100 soportes roscado gris	12,07
130481	100/5000	Envase 100 grapas brida GB 1632 negra	(4) 29,30
130482	100/5000	Envase 100 grapas brida GB 1632 gris	29,30

Válidos para las bridas de la página 16.



2
+3



GRAPA TACO HORMIGÓN

CÓDIGO	ENVASE EMBALAJE	DESCRIPCIÓN	€/ud
130451	100	Grapa-taco 8 hormigón 1x14	0,33
130452	100	Grapa-taco 8 hormigón 1x16	0,36
130453	100	Grapa-taco 8 hormigón 1x18	0,39
130454	100	Grapa-taco 8 hormigón 1x20	0,42
130455	100	Grapa-taco 8 hormigón 1x22	0,46
130456	100	Grapa-taco 8 hormigón 1x25	0,50
130457	100	Grapa-taco 8 hormigón 1x28	0,54
130462	100	Grapa-taco 8 hormigón 2x16	0,39
130463	100	Grapa-taco 8 hormigón 2x18	0,43
130464	100	Grapa-taco 8 hormigón 2x20	0,47
130465	100	Grapa-taco 8 hormigón 2x22	0,50
130466	100	Grapa-taco 8 hormigón 2x25	0,54
130467	100	Grapa-taco 8 hormigón 2x28	0,72



GRAPA UNIVERSAL MULTIFIJACIÓN

CÓDIGO	ENVASE EMBALAJE	DESCRIPCIÓN	€/ud
130471	10	Grapa univ. multifij. GUM-15/18 gris	0,32
130472	10	Grapa univ. multifij. GUM-20/25 gris	0,42
130473	10	Grapa univ. multifij. GUM-23/32 gris	0,49
130474	10	Grapa univ. multifij. GUM-15/18 blanca	0,32
130475	10	Grapa univ. multifij. GUM-20/25 blanca	0,42
130476	10	Grapa univ. multifij. GUM-23/32 blanca	0,49

APTO PARA INTERIORES Y EXTERIORES

- Poliamida 6 (-40° +80°).
- Libre de halógenos.
- Resistente a rayos ultravioleta.
- Protección del sonido.
- Cumple las normativas RoHS y REACH.

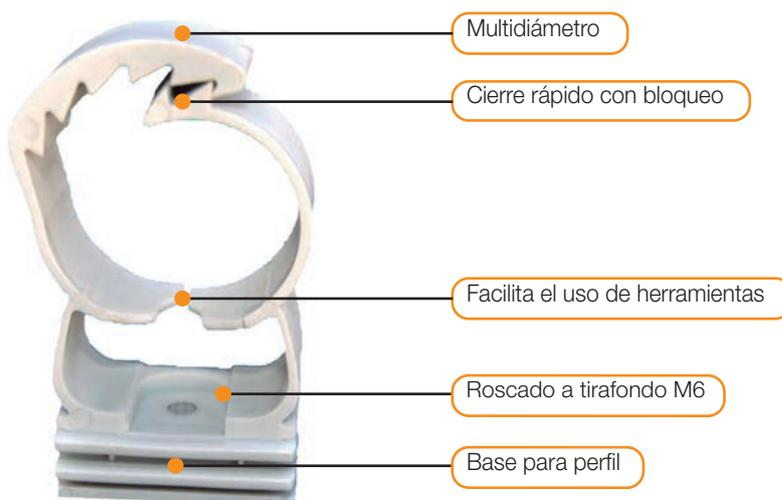

MULTIFIJACIÓN

Sistemas de fijación:

- Tirafondo M6.
- Tirafondo cabeza alomada.
- Tirafondo cabeza avellanada.
- Tiro de pistola.



FIJACIÓN A PERFIL



"C" 10x20



"C" 7,5x25

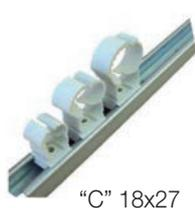

"C" 18x27





- **ÍNDICE REFERENCIAS**

- **DATOS TÉCNICOS**

CÓDIGO	P.V.P.	PAG.	CÓDIGO	P.V.P.	PAG.	CÓDIGO	P.V.P.	PAG.	CÓDIGO	P.V.P.	PAG.	CÓDIGO	P.V.P.	PAG.	CÓDIGO	P.V.P.	PAG.
015001	4,45	76	072252	122,80	103	081805	178,90	107	082514	101,75	111	083515	150,51	113	090826	44,24	117
015004	4,53	76	072253	172,46	103	081806	262,08	107	082515	110,28	111	083516	178,61	113	090901	61,60	108
015006	4,55	76	072254	222,34	103	081807	290,54	107	082516	131,62	111	083517	207,04	113	090902	103,24	108
015008	4,92	76	072255	272,12	103	081900	30,59	103	082517	153,07	111	083518	235,14	113	090904	10,29	118
015010	5,16	76	072256	324,09	103	081901	28,28	103	082518	174,35	111	083531	119,35	113	090905	14,91	118
015012	5,54	76	072257	61,64	103	081902	30,32	103	082531	91,19	111	083533	139,52	113	090906	19,65	118
015014	5,78	76	072258	97,60	103	081903	42,89	103	082533	114,84	111	083534	163,81	113	090909	129,75	108
015016	6,10	76	072259	53,50	103	081904	52,81	103	082534	129,14	111	083535	187,23	113	090910	304,32	108
015017	6,23	76	075111-Z	2,44	104	081905	80,37	103	082535	161,98	111	083536	212,34	113	090911	4,95	105
015018	6,39	76	075111-G	3,30	104	081906	111,08	103	082536	173,98	111	083537	236,08	113	090912	8,58	105
015019	6,93	76	075111-I	10,98	104	081907	150,66	103	082537	182,49	111	083542	70,73	113	090913	7,15	118
015020	7,32	76	075112-Z	5,73	104	081908	176,29	103	082542	38,50	111	083543	61,52	113	090915	10,84	105
015021	8,69	76	075112-G	10,66	104	081922	28,50	104	082543	48,68	111	083544	87,45	113	090916	46,20	105
015022	9,70	76	075112-I	17,64	104	081924	36,12	104	082544	65,89	111	083545	119,65	113	090918	23,05	105
015024	11,38	76	075113-Z	1,64	104	081926	consultar	104	082545	88,72	111	083546	153,04	113	090921	6,55	119
015025	12,24	76	075113-G	2,32	104	081928	consultar	104	082546	111,54	111	083547	185,56	113	090922	6,65	119
015026	13,84	76	075113-I	9,77	104	081932	19,14	109	082547	135,19	111	083548	219,07	113	090923	30,04	119
015027	14,82	76	075115-Z	2,15	105	081934	31,52	109	082548	164,61	111	083611	31,90	114	090924	35,04	119
015028	15,31	76	075115-G	2,97	105	082101	63,97	109	082611	28,88	111	083612	40,98	114	091010	10,84	117
015029	16,77	76	075115-I	9,94	105	082102	73,21	109	082612	34,27	111	083613	50,77	114	091011	12,86	117
015031	18,39	76	075117	4,87	105	082103	88,63	109	082613	44,44	111	083614	59,40	114	091012	14,91	117
015032	18,93	76	075130	7,21	105	082104	127,69	109	082614	50,05	111	083615	81,68	114	091013	19,36	117
015033	21,39	76	075131	10,32	105	082112	70,02	109	082615	65,18	111	083616	108,90	114	091014	31,90	117
015034	22,23	76	075132	27,50	105	082113	81,68	109	082616	74,97	111	083617	140,69	114	091015	35,81	117
015035	25,48	76	075133	39,37	105	082114	98,67	109	082617	100,93	111	083618	167,09	114	091016	47,58	117
015036	4,45	76	075134	16,67	105	082115	141,37	109	082618	114,29	111	083631	46,64	114	091020	15,62	117
015039	4,53	76	080101	25,94	106	082116	195,94	109	082631	40,32	111	083632	53,52	114	091021	18,10	117
015041	4,55	76	080102	31,13	106	082117	263,53	109	082632	51,32	111	083633	68,64	114	091022	21,07	117
015043	4,92	76	080103	36,44	106	082118	337,40	109	082634	73,15	111	083634	89,82	114	091023	26,51	117
015045	5,16	76	080104	58,38	106	082131	127,33	109	082635	95,15	111	083635	125,13	114	091024	41,03	117
015047	5,54	76	080201	26,24	106	082133	158,68	109	082636	116,88	111	083636	146,74	114	091025	49,50	117
015049	5,78	76	080202	27,30	106	082134	207,52	109	082637	160,77	111	083637	169,40	114	091026	70,24	117
015051	6,10	76	080203	32,66	106	082135	258,80	109	082638	182,60	111	083638	207,35	114	091040	59,02	117
015052	6,23	76	080204	38,43	106	082136	328,63	109	083112	101,41	112	090120	11,76	115	091041	70,95	117
015053	6,39	76	080205	57,53	106	082137	394,09	109	083113	115,65	112	090121	13,76	115	091042	78,38	117
015054	6,93	76	080206	85,05	106	082142	37,95	109	083114	141,01	112	090122	15,65	115	091043	86,96	117
015055	7,32	76	080207	107,94	106	082143	50,88	109	083115	204,23	112	090123	18,74	115	091044	106,70	117
015056	8,69	76	080208	157,13	106	082144	65,18	109	083116	290,56	112	090124	22,21	115	091045	117,43	117
015057	9,70	76	080401	51,45	106	082145	82,46	109	083117	395,86	112	090125	23,38	115	091046	132,22	117
015059	11,38	76	080403	63,68	106	082146	127,88	109	083118	502,11	112	090126	26,44	115	091111	33,00	116
015060	12,24	76	080404	90,30	106	082147	204,75	109	083131	152,74	112	090140	16,28	115	091112	42,79	116
015061	13,84	76	080405	112,35	106	082148	267,10	109	083133	187,66	112	090141	22,63	115	091113	52,69	116
015062	14,82	76	080406	163,28	106	082201	49,12	110	083134	266,37	112	090142	25,36	115	091114	73,92	116
015063	15,31	76	080407	173,78	106	082202	52,42	110	083135	359,33	112	090143	30,40	115	091115	122,14	116
015064	16,77	76	080601	26,82	106	082203	62,15	110	083136	471,71	112	090144	37,91	115	091122	42,16	116
015066	18,39	76	080602	27,30	106	082204	75,79	110	083137	598,06	112	090145	40,37	115	091123	64,23	116
015067	18,93	76	080603	32,66	106	082212	61,88	110	083142	59,86	112	090146	44,94	115	091124	72,05	116
015068	21,39	76	080604	38,43	106	082213	63,14	110	083143	91,79	112	090210	9,82	116	091126	101,01	116
015069	22,23	76	080605	57,53	106	082214	69,03	110	083144	73,99	112	090211	15,05	116	091128	183,36	116
015070	25,48	76	080606	85,05	106	082215	71,12	110	083145	121,07	112	090212	20,13	116	091180	157,50	119
070101	16,81	102	080607	107,94	106	082216	88,55	110	083146	195,94	112	090213	35,60	116	091181	247,50	119
070102	24,31	102	080608	157,13	106	082217	95,70	110	083147	279,33	112	090214	42,80	116	091182	319,50	119
070103	32,03	102	080801	51,45	106	082218	106,43	110	083148	376,17	112	090215	60,78	116	091183	945,70	119
070201	19,11	102	080803	63,68	106	082231	62,43	110	083212	78,33	112	090216	67,97	116	091184	1.519,00	119
070202	26,15	102	080804	90,30	106	082233	76,07	110	083213	84,86	112	090230	20,87	116	091185	1.205,40	119
070203	38,04	102	080805	112,35	106	082234	88,44	110	083214	92,26	112	090231	24,93	116	091186	1.984,50	119
070204	49,91	102	080806	163,28	106	082235	100,93	110	083215	108,42	112	090232	29,16	116	091187	2.018,80	119
070205	65,84	102	080807	173,78	106	082236	121,28	110	083216	123,81	112	090233	45,56	116	091188	2.651,50	119
070206	73,34	102	080900	21,38	103	082237	125,40	110	083217	144,30	112	090234	72,66	116	091189	3.248,70	119
070215	21,73	102	080901	19,92	103	082242	33,50	110	083218	155,69	112	090235	90,39	116	100102	4,70	2
070216	16,59	102	080902	15,77	103	082243	37,95	110	083231	76,00	112	090236	103,39	116	100103	5,04	2
070217	16,61	102	080903	21,20	103	082244	42,63	110	083233	102,59	112	090240	45,89	116	100104	6,43	2
070302	39,71	102	080904	25,92	103	082245	51,42	110	083234	116,78	112	090241	50,51	116	100105	7,83	2
070303	50,69	102	080905	43,97	103	082246	60,50	110	083235	125,88	112	090242	56,65	116	100106	7,10	2
070304	67,67	102	080906	59,90	103	082247	69,46	110	083236	139,69	112	090243	75,97	116	100108	8,08	2
070305	76,79	102	080907	84,74	103	082248	78,54	110	083237	153,12	112	090244	113,74	116	100109	9,16	2
070306	84,30	102	080908	100,36	103	082401	86,08	110	083242	34,33	112	090245	146,85	116	100110	11,26	2
071201-HR	23,47	102	080921	26,05	104	082402	95,87	110	083243	39,07	112	090246	172,70	116	100111	15,11	2
071																	

CÓDIGO	P.V.P.	PAG.	CÓDIGO	P.V.P.	PAG.	CÓDIGO	P.V.P.	PAG.	CÓDIGO	P.V.P.	PAG.	CÓDIGO	P.V.P.	PAG.	CÓDIGO	P.V.P.	PAG.
100234	28,94	3	101092	108,94	5	110642	13,69	95	120392	6,84	92	130475	0,42	128	150764	6,64	83
100235	34,26	3	101202	13,36	6	110643	16,15	95	120801	11,17	93	130476	0,49	128	150765	11,13	83
100303	316,80	3	101203	13,36	6	110644	18,11	95	120802	12,18	93	130481	29,30	127	150766	17,90	83
100313	49,50	3	101204	15,28	6	110645	0,83	95	120808	5,32	93	130482	29,30	127	150767	33,92	83
100401	0,57	4	101205	14,31	6	110646	0,97	95	120809	5,53	93	130501	3,38	126	150768	47,30	83
100402	0,81	4	101206	14,31	6	110647	1,05	95	130102	11,78	124	130502	3,43	126	150769	55,51	83
100403	1,34	4	101207	13,36	6	110648	4,59	95	130103	13,05	124	130503	3,69	126	150770	3,89	82
100404	1,94	4	101209	11,68	6	110649	4,29	95	130105	15,23	124	130504	3,94	126	150771	3,96	82
100405	3,88	4	101210	27,22	6	110650	6,26	95	130202	14,55	124	130505	4,41	126	150772	4,50	82
100411	0,69	4	101211	27,22	6	110651	11,93	95	130203	16,35	124	130506	4,79	126	150773	5,08	82
100412	0,94	4	101212	12,07	6	110652	444,22	95	130205	20,78	124	130507	5,23	126	150774	4,75	82
100413	1,63	4	101213	12,07	6	110653	136,22	95	130250	7,35	124	130508	6,17	126	150775	7,62	82
100414	2,37	4	101221	5,03	6	110701	4,84	96	130251	7,50	124	130509	6,69	126	150776	8,38	82
100415	4,58	4	101222	7,25	6	110711	2,77	96	130252	7,92	124	130510	7,09	126	150777	12,88	82
100501	1,72	4	101223	13,50	6	110712	2,77	96	130253	7,50	124	130511	7,31	126	150778	14,64	82
100502	3,30	4	101231	4,40	5	110713	3,23	96	130254	7,75	124	130512	8,14	126	150779	24,46	82
100503	4,95	4	101232	9,10	5	110714	1,62	96	130255	53,58	125	130513	8,30	126	150780	29,38	82
100504	12,66	4	101233	15,00	5	110715	2,43	96	130256	170,35	125	130521	10,72	121	150781	60,45	82
100511	3,97	4	101234	19,88	5	110716	2,43	96	130258	182,97	125	130522	11,12	121	150782	3,72	83
100513	7,89	4	101235	25,81	5	110751	133,69	96	130260	311,47	125	130523	12,72	121	150783	3,72	83
100516	24,23	4	101236	36,08	5	110752	150,14	96	130261	701,06	125	130524	10,72	121	150784	4,55	83
100519	72,65	4	101237	78,84	5	110753	157,37	96	130262	469,99	125	130525	11,12	121	150785	5,14	83
100602	3,23	68	110201	1,72	90	110754	183,60	96	130263	774,00	125	130526	12,72	121	150786	5,39	83
100612	3,44	68	110202	1,94	90	110801	6,80	97	130265	0,87	125	130527	9,85	121	150787	9,35	83
100622	3,63	68	110203	2,40	90	110802	7,24	97	130266	1,33	125	130530	8,76	121	150788	14,26	83
100631	3,74	68	110204	3,06	90	110803	10,27	97	130268	143,44	125	130551	12,87	122	150789	29,52	83
100632	3,74	68	110206	2,63	90	110804	10,88	97	130281	1,29	125	130552	13,66	122	150790	54,65	83
100633	3,74	68	110207	3,82	90	110805	11,98	97	130302	5,40	120	130553	17,87	122	150801	0,22	82
100634	3,74	68	110208	5,88	90	110806	12,60	97	130303	5,70	120	130555	7,70	122	150802	0,23	82
100635	6,52	68	110209	7,88	90	110807	87,21	97	130306	5,40	120	130556	8,20	122	150803	0,32	82
100641	4,93	68	110210	9,28	90	110808	88,03	97	130307	5,70	120	130557	10,45	122	150804	0,51	82
100642	4,93	68	110221	2,02	90	110810	28,48	97	130310	5,40	120	130558	11,04	122	150805	0,76	82
100643	4,93	68	110222	2,90	90	110811	56,80	98	130311	5,70	120	130561	4,85	122	150806	1,41	82
100644	4,93	68	110223	3,19	90	110812	168,10	98	130321	6,04	120	130562	5,89	122	150807	2,30	82
100645	9,63	68	110251	3,62	91	110813	175,92	98	130322	6,04	120	130563	6,39	122	150808	3,53	82
100651	5,10	68	110252	4,24	91	110821	654,79	98	130323	6,04	120	130564	7,35	122	150809	0,21	82
100652	5,10	68	110253	6,19	91	110822	1.063,97	98	130324	6,04	120	130565	2,40	123	150810	0,21	82
100653	5,10	68	110254	7,52	91	110823	1.438,71	98	130325	6,04	120	130566	7,60	123	150811	0,22	82
100654	5,10	68	110255	6,20	91	110831	1.400,41	98	130326	6,04	120	130567	6,28	123	150812	0,25	82
100655	9,81	68	110256	6,90	91	110832	1.431,75	98	130331	2,67	120	130568	6,28	123	150813	0,31	82
100661	5,21	68	110257	7,70	91	110834	2.232,74	98	130332	2,97	120	130569	5,42	123	150814	0,50	82
100662	5,21	68	110258	9,66	91	110835	2.279,79	98	130333	3,27	120	130570	5,60	123	150815	0,74	82
100662-B	4,35	68	110259	13,58	91	110837	3.144,55	98	130334	3,47	120	130571	5,86	123	150816	1,25	82
100663	5,21	68	110271	4,83	90	110838	3.207,26	98	130335	5,91	120	130572	6,03	123	150817	2,22	82
100664	5,21	68	110272	4,83	90	120111	9,74	92	130336	6,26	120	130573	9,23	123	150818	2,82	82
100665	10,03	68	110301	0,20	91	120112	10,68	92	130337	6,48	120	130802	25,41	12	150819	0,37	83
100671	6,41	68	110302	0,22	91	120113	14,51	92	130338	6,73	120	130803	35,57	12	150820	0,49	83
100672	6,41	68	110303	0,25	91	120114	17,86	92	130339	6,25	121	130804	59,71	12	150821	0,67	83
100672-B	5,62	68	110308	179,08	91	120116	17,50	92	130340	6,35	121	130812	10,16	118	150822	1,05	83
100673	6,41	68	110503	4,89	97	120117	20,67	92	130341	4,07	121	130813	11,80	118	150823	1,51	83
100674	6,41	68	110504	8,75	97	120119	30,28	92	130342	4,46	121	130814	13,28	118	150824	2,51	83
100675	12,24	68	110505	9,34	97	120120	36,69	92	130343	4,83	121	141020	18,61	77	150825	4,67	83
100681	7,25	68	110507	10,62	97	120134	23,21	93	130401	0,54	126	141021	26,80	77	150826	7,80	83
100682	7,25	68	110508	13,01	97	120135	28,20	93	130402	0,54	126	141022	31,61	77	150827	0,35	83
100682-B	6,81	68	110509	17,61	97	120202	7,55	92	130403	0,54	126	141023	74,54	77	150828	0,42	83
100683	7,25	68	110510	18,45	97	120203	8,37	92	130404	0,54	126	141024	46,33	77	150829	0,48	83
100684	7,25	68	110581	8,24	97	120204	10,34	92	130405	0,57	126	141025	74,98	77	150830	0,54	83
100685	13,94	68	110582	8,75	97	120206	10,63	92	130406	0,57	126	141026	130,31	77	150831	0,67	83
100687-B	18,72	68	110583	10,81	97	120207	12,01	92	130407	0,66	126	141027	226,00	77	150832	1,11	83
100688-B	23,91	68	110584	8,72	97	120209	18,87	92	130408	0,86	126	141031	19,87	77	150833	1,51	83
100690-B	31,75	68	110585	9,92	97	120210	21,93	92	130409	1,03	126	141032	25,74	77	150834	3,30	83
100691	12,69	68	110586	18,66	97	120222	7,55	92	130411	0,54	126	141033	37,66	77	150835	5,12	83
100692	12,69	68	110601	8,20	94	120223	8,37	92	130412	0,54	126	141034	57,01	77	150836	5,80	83
100692-B	12,32	68	110602	10,23	94	120224	10,34	92	130413	0,54	126	141035	94,99	77	150851	1,24	86
100693	12,69	68	110603	13,55	94	120226	10,63	92	130414	0,54	126	150701	0,80	82	150852	1,34	86
100694	12,69	68	110611	4,68	94	120227	12,01	92	130415	0,57	126	150702	0,98	82	150853	1,50	86
100695	24,47	68	110612	5,72	94	120229	18,87	92	130416	0,57	126	150703	0,86	82	150854	3,08	86
100711	17,48	69	110613	5,89	94	120230	21,93	92	130417	0,66	126	150704	0,98	82	150855	5,39	86
100712	26,71	69	110614	4,68	94	120242	10,68	92	130418	0,86	126	150705	0,98	82	150856	9,80	86
100713	33,56	69	110615	5,72	94	120243	11,98	92	130419	1,03	126	150706	1,68	82	150857	13,96	86
100714	43,27	69	110616	5,89	94	120244	13,04	92	130421	0,54	126	150707	3,36	82	150858	27,04	86

CÓDIGO	P.V.P.	PAG.	CÓDIGO	P.V.P.	PAG.	CÓDIGO	P.V.P.	PAG.	CÓDIGO	P.V.P.	PAG.	CÓDIGO	P.V.P.	PAG.	CÓDIGO	P.V.P.	PAG.
150885	2,78	86	151524	212,56	89	160219	31,25	101	181234	9,53	8	200449	20,46	11	200664	22,16	12
150886	3,71	86	151527	sin cargo	89	160220	25,79	101	181235	13,03	8	200450	23,38	11	200665	36,62	12
150887	4,59	86	151528	sin cargo	89	160221	6,76	101	181236	17,64	8	200451	29,23	11	200703	5,08	11
150901	2,99	84	151529	sin cargo	89	160231	4,98	101	181237	22,23	8	200461	7,37	11	200704	6,99	11
150902	3,70	84	151531	42,02	89	160232	5,25	101	181251	4,01	8	200463	8,79	11	200705	10,16	11
150903	5,61	84	151532	26,67	89	160233	5,72	101	181252	5,06	8	200465	10,16	11	200715	20,69	11
150904	9,48	84	151533	29,32	89	160234	7,03	101	181253	7,97	8	200466	10,61	11	200716	22,00	11
150905	14,37	84	151534	29,96	89	160251	5,17	101	181254	10,22	8	200467	11,62	11	200718	22,01	11
150906	24,09	84	151535	31,55	89	160253	6,38	101	181255	20,64	8	200468	12,06	11	200719	23,48	11
150907	52,88	84	151536	16,93	89	160254	13,11	101	181281	10,66	8	200469	12,68	11	200743	25,21	11
150910	1,78	84	151537	17,78	89	160255	2,13	101	181283	11,39	8	200471	8,70	11	200744	26,68	11
150911	2,25	84	151538	18,64	89	160256	3,18	101	181285	17,30	8	200473	10,31	11	200752	49,22	12
150912	2,48	84	151539	20,22	89	160401	46,28	100	181286	23,96	8	200475	10,76	11	200753	56,84	12
150913	2,84	84	151540	0,98	89	160402	58,12	100	191306	7,05	8	200476	11,20	11	200754	80,04	12
150914	2,84	84	152001	4,32	78	160403	68,86	100	191307	7,05	8	200477	12,08	11	200901	1,55	10
150915	5,33	84	152002	4,76	78	160404	72,32	100	191311	8,32	8	200478	13,56	11	200912	10,09	10
150916	9,41	84	152003	4,03	78	160406	44,67	100	191312	8,32	8	200479	14,74	11	200914	8,12	10
150917	17,42	84	152004	4,69	78	160407	47,94	100	191313	8,52	8	200480	17,54	11	201002	5,09	13
150918	25,16	84	152005	-2,35	78	160408	54,97	100	191321	11,71	8	200481	12,53	11	201003	6,89	13
150919	31,67	84	152006	2,57	78	160411	4,77	100	191322	14,91	8	200483	13,42	11	201008	10,69	13
150920	1,68	84	152007	3,08	78	160413	4,95	100	191326	20,10	8	200485	14,15	11	201009	13,31	13
150921	2,69	84	152008	5,12	78	160415	25,48	100	191332	37,34	8	200486	15,03	11	201021	10,16	13
150922	1,97	84	152009	5,50	78	160416	38,97	100	191403	8,12	8	200487	15,77	11	201022	13,08	13
150923	4,93	84	152010	8,50	78	160417	4,41	100	191404	8,65	8	200488	19,16	11	201026	13,67	13
150924	3,68	84	152011	1,46	78	160418	7,29	100	191408	12,11	8	200489	20,63	11	201027	16,74	13
150925	7,99	84	152012	1,76	78	160421	21,86	101	191411	17,57	8	200490	23,59	11	201101	0,53	13
150926	5,33	84	152013	2,12	78	160422	21,86	101	191422	22,36	8	200491	29,48	11	201102	0,69	13
150927	12,64	84	152014	6,59	78	160423	26,06	101	191503	7,05	8	200511	9,78	11	201103	1,04	13
150928	9,60	84	152015	7,18	78	160424	26,06	101	191504	7,05	8	200513	10,38	11	201104	1,41	13
150929	16,86	84	152016	6,52	78	160425	31,27	101	191515	13,18	8	200515	10,95	11	201105	1,94	13
150930	14,30	84	152017	1,46	78	160426	31,27	101	191518	11,71	8	200516	11,26	11	201106	4,10	13
150931	38,03	84	152018	6,96	78	160431	101,43	100	191523	17,97	8	200517	11,99	11	201112	0,48	13
150932	30,97	84	152021	8,50	79	160432	104,79	100	191531	17,17	8	200518	12,86	11	201113	0,78	13
150933	1,39	85	152022	10,91	79	160433	112,93	100	191990	6,05	8	200519	13,58	11	201114	1,10	13
150934	1,98	85	152023	15,01	79	160435	143,47	100	191994	9,68	8	200526	13,16	11	201121	0,59	13
150935	1,45	85	152024	20,14	79	160436	156,34	100	200101	1,51	9	200528	13,58	11	201122	0,68	13
150936	1,78	85	152027	8,12	79	160437	164,32	100	200102	3,27	9	200530	14,17	11	201123	0,73	13
150937	1,47	85	152028	10,55	79	160440	85,83	101	200202	0,19	8	200531	14,46	11	201124	0,87	13
150938	2,22	85	152029	14,06	79	160441	92,61	101	200203	0,24	8	200532	15,05	11	201151	0,28	13
150939	1,84	85	152030	18,59	79	160442	97,23	101	200205	0,28	8	200533	15,35	11	201152	0,30	13
150940	1,57	85	152033	18,46	79	160446	111,28	101	200209	0,43	8	200534	17,53	11	201153	0,33	13
150941	5,30	85	152034	24,60	79	160447	119,29	101	200301	0,81	9	200535	19,00	11	201154	0,34	13
150942	4,50	85	152035	25,78	79	160448	127,30	101	200302	0,86	9	200536	20,46	11	201155	0,40	13
150943	3,28	85	152036	27,38	79	160449	49,18	101	200303	0,96	9	200541	20,17	11	201156	0,46	13
150944	9,94	85	152037	43,34	79	160451	67,35	101	200304	1,10	9	200543	21,19	11	201157	0,58	13
150945	5,34	85	152038	25,55	79	160452	74,74	101	200305	1,14	9	200545	23,23	11	201181	13,79	73
150946	15,18	85	152039	31,92	79	160453	83,52	101	200306	1,32	9	200546	24,54	11	201182	18,84	73
150947	12,58	85	152040	35,95	79	160455	113,18	100	200307	1,40	9	200547	27,63	11	201201	9,64	14
150948	18,92	85	152041	38,29	79	160456	140,55	100	200308	1,58	9	200548	30,68	11	201402	13,36	14
150950	23,92	85	152042	42,10	79	160457	13,66	100	200309	1,65	9	200549	33,61	11	201403	16,00	14
150951	24,80	85	152043	40,86	79	160458	9,29	100	200310	1,87	9	200550	37,99	11	201404	17,51	14
150952	1,91	85	152044	45,10	79	160459	5,86	100	200311	2,12	9	200551	42,38	11	201405	20,32	14
150953	2,80	85	152045	80,52	79	160566	7,60	123	200313	2,35	9	200602	5,04	12	201406	23,38	14
150954	2,35	85	152046	120,49	79	160621	2,86	101	200314	2,56	9	200603	5,95	12	201416	58,09	14
150955	3,09	85	152047	10,76	80	160622	3,73	101	200315	2,78	9	200604	7,46	12	201501	24,49	14
150956	2,26	85	152048	11,71	80	160623	5,56	101	200316	3,02	9	200605	10,52	12	201502	27,55	14
150957	2,28	85	152049	14,06	80	160624	7,39	101	200317	3,20	9	200606	16,92	12	201801	2,05	14
150958	2,44	85	152050	16,55	80	160626	12,65	101	200326	6,89	9	200607	23,63	12	201802	4,33	14
150959	3,18	85	152051	10,98	80	160631	3,30	101	200331	1,64	9	200612	3,67	12	201901	30,90	15
150960	3,69	85	152052	16,55	80	160632	4,07	101	200332	1,92	9	200613	4,42	12	201902	31,90	15
150961	4,14	85	152053	14,72	80	160633	6,49	101	200334	2,20	9	200614	5,34	12	201903	32,90	15
150962	5,81	85	152054	17,72	80	160634	7,48	101	200336	2,36	9	200615	7,32	12	201904	63,00	15
150963	6,42	85	152055	57,66	80	160636	10,99	101	200337	2,48	9	200616	9,15	12	201905	63,00	15
150964	6,45	85	152056	26,58	80	160637	18,42	101	200338	3,16	9	200617	15,08	12	201906	8,20	16
150965	12,00	85	152057	37,49	80	160638	46,29	101	200339	3,56	9	200622	5,19	12	201907	8,32	16
150966	13,96	85	152058	33,83	80	160639	65,01	101	200340	4,72	9	200623	5,96	12	201908	8,55	16
150967	18,29	85	152059	42,97	80	180102	134,60	7	200351	3,64	9	200624	7,32	12	201909	11,09	16
150968	32,47	85	152060	90,78	80	180103	177,42	7	200352	3,74	9	200625	10,52	12	201910	18,48	16
150969	32,78	85	160101	12,97	99	180104	225,44	7	200353	3,94	9	200626	15,10	12	201911	4,16	16
150970	27,78	85	160102	18,88	99	180105	250,94	7	200354	4,45	9	200627	21,36	12	201912	4,85	16
150971	27,90	85	160103	25,28	99	180173	178,10	7	200355	4,82	9	200632	4,57	12	201913	5,54	16
150972	47,16	85	160104	35,74	99	18											

CÓDIGO	P.V.P.	PAG.	CÓDIGO	P.V.P.	PAG.	CÓDIGO	P.V.P.	PAG.	CÓDIGO	P.V.P.	PAG.	CÓDIGO	P.V.P.	PAG.	CÓDIGO	P.V.P.	PAG.
201949	50,16	16	210841	35,96	47	211214	38,60	34	211827	25,99	37	220306	10,60	48	220522	consultar	20
201950	50,00	15	210846	42,35	47	211215	41,97	34	211828	34,52	37	220307	15,98	48	220523	consultar	20
201951	51,00	15	210847	42,35	47	211216	44,29	34	211829	44,76	37	220308	15,98	48	220524	consultar	20
201952	55,00	15	210858	48,60	47	211217	44,29	34	211830	39,85	37	220309	15,98	48	220531	consultar	20
201953	80,00	15	210859	48,60	47	211218	44,29	34	211831	53,71	37	220310	24,93	48	220532	consultar	20
201954	160,00	15	210911	14,77	29	211219	59,03	34	211832	83,14	37	220311	24,93	48	220541	consultar	20
201960	39,99	15	210912	20,86	29	211220	51,04	34	211901	15,13	37	220312	24,93	48	220542	consultar	20
201961	45,80	15	210921	16,18	29	211221	51,04	34	211901	15,13	37	220313	39,78	48	220543	consultar	20
201962	78,60	15	210922	28,82	29	211222	51,04	34	211903	15,13	37	220314	39,78	48	220544	consultar	20
201963	89,75	15	210923	80,02	29	211223	57,99	34	211904	16,40	37	220315	39,78	48	220545	consultar	20
201964	176,20	15	210924	22,79	29	211224	69,20	34	211905	18,02	37	220316	8,06	48	220546	consultar	20
210201	1,28	21	210925	32,25	29	211225	36,38	34	211906	43,67	37	220317	8,06	48	220551	consultar	20
210202	1,67	21	210926	85,76	29	211226	36,38	34	211907	66,94	37	220318	8,06	48	220552	consultar	20
210209	2,45	21	210931	23,37	29	211227	39,88	34	211908	87,32	37	220319	15,98	49	220553	consultar	20
210211	2,56	21	210932	36,08	29	211228	47,30	34	211909	50,94	37	220320	15,98	49	220554	consultar	20
210212	3,35	21	210933	86,39	29	211229	55,38	34	220101	8,25	26	220321	15,98	49	220555	consultar	20
210213	4,66	21	210934	26,69	29	211230	55,38	34	220102	12,47	26	220322	17,78	49	220565	48,58	20
210214	6,55	21	210935	39,23	29	211231	58,13	34	220103	12,98	26	220323	17,78	49	220566	87,85	20
210215	8,74	21	210936	97,53	29	211232	60,19	34	220104	16,82	26	220324	17,78	49	220567	1,40	20
210216	13,33	21	211002	2,14	30	211233	70,89	34	220105	24,35	26	220325	26,78	49	220571	0,90	21
210217	19,48	21	211003	2,67	30	211237	31,75	34	220106	34,08	26	220326	26,78	49	220572	13,10	21
210401	6,10	28	211004	4,24	30	211238	31,75	34	220107	31,00	26	220327	26,78	49	220573	13,20	21
210402	7,89	28	211005	10,80	30	211239	31,75	34	220108	31,00	26	220328	37,58	49	220574	13,31	21
210403	9,77	28	211007	2,14	30	211240	31,75	34	220109	38,05	26	220329	37,58	49	220575	13,44	21
210405	17,72	28	211008	2,67	30	211241	36,28	34	220110	55,06	26	220330	37,58	49	220576	13,55	21
210406	7,37	28	211009	4,24	30	211242	45,53	34	220111	97,60	26	220331	67,68	49	220577	13,94	21
210407	10,29	28	211010	10,80	30	211243	45,53	34	220112	102,04	26	220332	67,68	49	220578	14,97	21
210408	14,76	28	211025	2,29	31	211244	45,53	34	220113	57,60	26	220333	67,68	49	220579	22,86	21
210409	22,33	28	211026	2,78	31	211245	51,57	34	220114	63,25	26	220401	17,31	38	220581	26,97	21
210601	6,57	30	211027	3,25	31	211246	52,55	34	220115	84,54	26	220402	5,59	39	220582	31,71	21
210604	9,20	30	211028	6,29	31	211247	64,02	34	220116	97,60	26	220403	6,23	39	220583	39,69	21
210711	18,54	30	211029	6,78	31	211248	64,02	34	220117	82,50	26	220404	29,95	39	220584	49,14	21
210712	21,50	30	211031	5,77	31	211249	64,02	34	220118	99,98	26	220405	38,51	39	220585	69,39	21
210713	27,57	30	211037	7,30	31	211250	69,33	34	220119	120,15	26	220406	41,51	39	220586	92,19	21
210714	35,14	30	211039	3,64	31	211251	69,33	34	220121	0,77	27	220407	11,18	39	220603	consultar	22
210731	0,84	32	211040	5,18	31	211252	52,65	34	220122	0,95	27	220408	10,49	39	220605	consultar	22
210732	0,84	32	211041	7,06	31	211253	52,65	34	220123	1,11	27	220409	29,99	39	220608	consultar	22
210733	0,75	32	211043	8,85	31	211254	52,65	34	220131	4,57	27	220410	46,18	39	220609	consultar	22
210734	0,75	32	211045	15,88	31	211255	52,65	34	220132	5,28	27	220411	10,55	38	220610	consultar	22
210735	1,16	32	211046	20,98	31	211256	68,83	34	220133	8,26	27	220412	13,85	38	220611	consultar	22
210736	1,16	32	211047	36,38	31	211257	68,83	34	220150	18,25	42	220413	26,43	38	220612	consultar	22
210737	1,27	32	211051	9,43	31	211258	68,83	34	220151	25,25	42	220414	8,10	38	220613	consultar	22
210738	1,27	32	211052	13,87	31	211259	68,83	34	220152	35,80	42	220415	10,43	38	220614	consultar	22
210739	1,82	32	211053	16,85	31	211260	91,24	34	220153	47,50	42	220416	12,45	38	220615	consultar	22
210740	1,82	32	211054	27,94	31	211261	91,24	34	220154	49,20	42	220421	5,72	38	220616	consultar	22
210741	3,29	32	211055	34,26	31	211262	91,24	34	220155	26,50	42	220422	7,24	38	220617	consultar	22
210742	3,29	32	211076	2,07	33	211263	91,24	34	220156	38,60	42	220423	9,02	38	220618	consultar	22
210743	10,23	32	211078	2,39	33	211264	60,58	34	220157	48,53	42	220425	7,92	38	220619	consultar	22
210744	10,23	32	211079	2,97	33	211265	60,58	34	220158	52,30	42	220426	10,85	38	220620	consultar	22
210750	0,84	32	211081	2,55	33	211266	60,58	34	220161	77,27	43	220427	17,17	38	220621	consultar	22
210751	0,84	32	211083	3,15	33	211301	25,98	35	220162	92,22	43	220430	120,48	39	220622	consultar	22
210752	0,46	32	211084	4,05	33	211302	29,44	35	220171	19,52	43	220431	188,38	39	220623	consultar	22
210753	0,46	32	211091	0,41	33	211303	42,55	35	220172	37,37	43	220432	5,59	39	220624	consultar	22
210754	0,70	32	211092	0,52	33	211304	46,83	35	220173	60,80	43	220433	3,56	39	220624	consultar	22
210755	0,70	32	211093	0,85	33	211305	52,75	35	220174	70,90	43	220434	4,60	39	220625	consultar	22
210756	0,76	32	211103	3,84	36	211306	66,45	35	220175	86,26	43	220435	57,65	39	220626	consultar	22
210757	0,76	32	211104	5,69	36	211307	42,12	35	220177	3,76	43	220436	37,54	39	220627	consultar	22
210758	1,16	32	211105	6,16	36	211308	59,32	35	220178	12,28	43	220437	1,03	39	220628	consultar	22
210759	1,16	32	211106	7,04	36	211310	31,45	35	220179	12,75	43	220438	1,91	39	220629	consultar	22
210760	0,46	32	211107	8,77	36	211311	49,94	35	220190	14,66	46	220439	0,64	39	220630	consultar	22
210761	0,64	32	211108	18,40	36	211312	64,80	35	220191	22,86	46	220440	0,83	39	220631	consultar	22
210762	0,88	32	211109	25,11	36	211313	59,92	35	220192	32,47	46	220443	29,79	40	220632	consultar	22
210763	0,94	32	211110	41,63	36	211314	65,02	35	220193	54,17	46	220444	15,17	40	220633	consultar	22
210764	1,38	32	211111	2,93	36	211315	91,94	35	220194	80,38	46	220445	15,65	40	220634	consultar	22
210766	0,77	33	211112	4,03	36	211316	62,25	35	220195	123,02	46	220446	31,87	40	220635	consultar	22
210767	1,54	33	211113	4,89	36	211701	12,72	35	220196	205,06	46	220447	32,07	40	220636	consultar	22
210770	4,35	32	211114	6,36	36	211702	23,30	35	220197	92,16	46	220448	43,06	40	220637	consultar	22
210771	4,35	32	211115	7,94	36	211703	30,34	35	220198	128,95	46	220449	25,89	40	220638	consultar	22
210772	5,15	32	211116	15,28	36	211704	35,96	35	220199	136,68	46	220450	24,69	40	220639	consultar	22
210773	5,49	32	211117	21,28	36	211705	65,56	35	220201	103,86	47	220451	33,66	40	220640	consultar	22
210774	7,59	32	211118	35,60	36	211711	21,73	35	220202	44,64	47	220452	45,35	40	220641	consultar	22
210775	10,19	32	211134	2,38	36	211712	35,43	35	220204	15,16	47	220453	107,62	40	220642	consultar	22
210776																	

CÓDIGO	P.V.P.	PAG.	CÓDIGO	P.V.P.	PAG.	CÓDIGO	P.V.P.	PAG.	CÓDIGO	P.V.P.	PAG.	CÓDIGO	P.V.P.	PAG.	CÓDIGO	P.V.P.	PAG.
220706	consultar	24	221209	consultar	23	240511	62,98	51	270502	62,65	59	310317	2,53	63	320111	10,30	72
220707	consultar	24	221210	consultar	23	240516	77,26	51	270701	2,50	60	310321	19,74	64	320112	13,31	72
220708	consultar	24	221211	consultar	23	240601	455,88	52	270702	3,79	60	310322	23,95	64	320114	24,85	72
220709	consultar	24	221212	consultar	23	240602	545,49	52	270703	5,15	60	310323	20,72	64	320115	30,62	72
220710	consultar	24	221213	consultar	23	240603	84,55	52	270705	1,50	58	310324	65,64	64	320116	50,78	72
220711	consultar	24	221214	consultar	23	240604	149,33	52	270711	5,96	59	310405	85,54	66	320141	8,51	72
220712	consultar	24	221215	consultar	23	240605	168,81	52	270712	2,10	60	310406	107,87	66	320144	12,41	72
220713	consultar	24	221216	consultar	23	240606	173,26	52	270713	14,69	61	310407	105,98	66	320145	18,11	72
220714	consultar	24	221217	consultar	23	240607	189,34	52	270721	6,49	60	310408	135,63	66	320146	22,52	72
220715	consultar	24	221218	consultar	23	240610	9,44	52	270722	9,95	60	310411	71,53	66	320161	12,70	72
220716	consultar	24	221219	consultar	23	240611	12,13	52	270724	27,94	60	310415	48,63	66	320162	16,94	72
220717	consultar	24	221220	consultar	23	240612	14,64	52	270730	1,61	60	310416	48,63	66	320163	26,79	72
220718	consultar	24	221221	consultar	23	240613	19,88	52	270731	1,75	60	310417	66,35	66	320164	35,36	72
220719	consultar	24	221222	consultar	23	240614	23,62	52	270732	1,81	60	310421	55,71	66	320166	14,62	72
220720	consultar	24	221223	consultar	23	240615	28,02	52	270733	2,14	60	310422	62,14	66	320167	19,43	72
220721	consultar	24	221224	consultar	23	240616	35,76	52	270734	2,33	60	310423	84,24	66	320168	27,17	72
220722	consultar	24	221225	consultar	23	240617	43,12	52	270735	3,05	60	310430	219,91	67	320171	3,24	73
220723	consultar	24	221226	consultar	23	240618	50,19	52	270736	3,62	60	310431	27,87	67	320172	4,55	73
220724	consultar	24	221227	consultar	23	240619	66,93	52	270802	31,95	61	310501	2,25	64	320174	6,77	73
220725	consultar	24	221228	consultar	23	240620	85,95	52	270803	34,46	61	310502	2,25	64	320176	9,04	73
220726	consultar	24	221229	consultar	23	240630	314,89	52	270804	39,98	61	310503	1,60	64	320178	13,59	73
220727	consultar	24	221230	consultar	23	240631	314,89	52	270805	91,71	61	310504	4,30	64	320181	8,04	72
220728	consultar	24	221231	consultar	23	240632	314,89	52	270901	3,01	61	310505	3,92	64	320182	9,12	72
220729	consultar	24	221232	consultar	23	240633	314,89	52	270902	3,09	61	310701	3,80	65	320183	10,08	72
220730	consultar	24	221233	consultar	23	240634	314,89	53	270903	3,22	61	310702	4,39	65	320184	13,21	72
220731	consultar	24	221234	consultar	23	240635	314,89	53	270904	3,16	61	310703	5,27	65	320185	16,88	72
220732	consultar	24	221235	consultar	23	240636	314,89	53	270905	3,32	61	310704	6,60	65	320186	80,56	72
220733	consultar	24	221236	consultar	23	240637	314,89	53	270906	3,62	61	310705	7,93	65	320191	30,14	72
220734	consultar	24	221237	consultar	23	240638	314,89	53	270907	3,21	61	310706	8,66	65	320301	9,10	74
220735	consultar	24	221238	consultar	23	240639	314,89	53	270908	3,32	61	310707	9,99	65	320302	11,72	74
220736	consultar	24	221239	consultar	23	240640	314,89	53	270909	3,40	61	310708	9,99	65	320303	54,50	74
220737	consultar	24	221240	consultar	23	240641	314,89	53	270931	3,99	61	310709	11,97	65	320323	7,25	74
220738	consultar	24	221241	consultar	23	240642	314,89	53	270932	4,11	61	310710	15,44	65	320402	2,36	74
220739	consultar	24	221242	consultar	23	240643	314,89	53	270933	4,25	61	310711	15,44	65	320416	6,01	74
220740	consultar	24	221244	consultar	23	240651	265,61	53	270934	4,29	61	310717	20,23	65	320426	9,50	74
220741	consultar	24	221245	consultar	23	240654	76,07	53	270935	4,77	61	310800	3,93	65	320501	5,57	73
220742	consultar	24	221246	consultar	23	240655	27,28	53	270936	4,77	61	310801	4,24	65	320502	6,71	73
220743	consultar	24	221247	consultar	23	240656	27,28	53	270937	4,77	61	310802	6,04	65	320503	17,79	73
220744	consultar	24	221248	consultar	23	250112	110,00	56	270938	4,97	61	310803	6,70	65	320504	18,81	73
220745	consultar	24	221249	consultar	23	250113	110,00	56	270939	5,06	61	310804	9,03	65	320506	6,77	73
220746	consultar	24	221250	consultar	23	250114	88,00	55	270940	7,62	61	310805	10,62	65	320512	4,72	73
221101	consultar	18	221251	consultar	23	250115	110,00	56	271001	10,63	58	310811	6,04	65	320608	1,94	73
221102	consultar	18	221252	consultar	23	250116	120,00	55	290101	1,47	70	310812	7,87	65	320609	2,27	73
221103	consultar	18	221253	consultar	23	250117	110,00	56	290101-R	0,36	70	310813	9,48	65	320610	2,41	73
221104	consultar	18	221254	consultar	23	250118	75,00	55	290102	2,04	70	310814	10,06	65	320611	13,98	73
221105	consultar	18	221255	consultar	23	250119	25,30	54	290103-R	0,36	70	310821	8,30	65	320612	13,98	73
221106	consultar	18	221256	consultar	23	250120	41,75	54	290104-R	0,36	70	310822	9,64	65	320703	9,23	74
221107	consultar	18	221257	consultar	23	250121	83,79	54	290105	4,42	70	310823	10,25	65	322101	19,83	75
221108	consultar	18	221258	consultar	23	250122	125,24	54	290106	8,85	70	310824	12,76	65	322102	20,80	75
221109	consultar	18	221259	consultar	23	250123	294,40	54	290107	12,05	70	310825	16,84	65	322104	23,99	75
221110	consultar	18	240101	21,95	50	250124	37,95	54	290108	1,47	70	310831	26,26	65	322105	33,32	75
221111	consultar	18	240102	28,88	50	250125	69,58	54	290111	12,80	70	310832	7,56	65	322106	43,71	75
221112	consultar	18	240103	51,98	50	250126	120,18	54	290112	16,98	70	310902	7,92	65	322107	38,97	75
221113	consultar	18	240111	90,00	50	250127	177,10	54	290113	13,02	70	310903	7,92	65	322108	23,23	75
221114	consultar	18	240112	110,00	50	250128	442,75	54	290114	24,48	70	310904	8,47	65	322109	27,63	75
221115	consultar	18	240201	3,31	50	250129	135,20	57	290202	16,84	70	311101	0,70	69	322110	36,35	75
221116	consultar	18	240202	4,04	50	250130	176,40	57	290203	17,25	70	311102	0,78	69	322111	43,96	75
221117	consultar	18	240204	7,30	50	250131	228,80	57	290204	15,50	70	311103	0,94	69	322112	46,91	75
221118	consultar	18	240206	12,00	50	250132	306,80	57	290301	133,10	71	311104	0,99	69	322113	48,21	75
221119	consultar	18	240207	7,50	50	250133	421,20	57	290302	145,20	71	311105	1,56	69	322114	52,29	75
221120	consultar	18	240208	12,00	50	250134	738,40	57	290303	145,20	71	311106	2,08	69	322202	26,27	73
221121	consultar	18	240209	330,00	50	250135	447,20	57	290401	119,36	71	311107	2,90	69	322203	68,68	73
221122	consultar	18	240221	20,21	54	250136	20,14	55	290411	16,84	71	311108	6,88	69	322204	69,13	73
221123	consultar	18	240222	21,23	54	250137	37,58	55	290415	9,99	71	311109	8,54	69	322205	266,00	73
221124	consultar	18	240301	51,98	50	250138	29,04	55	290419	22,52	71	311110	10,75	69	322206	74,52	73
221125	consultar	18	240302	86,63	50	250139	35,77	55	290420	22,52	71	311111	12,03	69	322207	75,17	73
221126	consultar	18	240303	70,46	50	250140	47,92	55	290421	22,52	71	311112	12,03	69	400101	6,64	90
221127	consultar	18	240304	125,89	50	250141	55,05	55	290422	22,52	71	311113	12,03	69	400102	11,44	90
221128	consultar	18	240305	212,23	50	250142	54,83	55	290423	22,52	71	311114	12,03	69	240506-IB	22,24	51
221129	consultar	18	240306	439,59	50	250143	106,07	55	290424	22,52	71	311115	15,34	69	240507-IB	23,09	51
221130	consultar	18	240307	136,00	50	250144	143,45	55	290425	22,52	71	311116	15,34	69			
221131	consultar	18	240309	133,03	50	250145	175,69	55	290426	22,52	71	311117	16,74	69			
221132	consultar	18	240401	14,62	25	250146	175,69	55	290427	22,52	71	311118	21,35				

CANALETA RANURADA

CARACTERÍSTICAS DEL MATERIAL

· PVC Rígido			
· Características eléctricas:			
- Espesor:	1,55 – 1,6 g/cm ³		
- Resistencia a la tracción:	40 N/mm ² , DIN53455		
- Temperatura de reblandecimiento:	80°C	Certificados	
- Resistencia al impacto:	8kJ/m ²		Conforme a normativa europea 2006/95/EC
· Características térmicas:			
- Resistencia al fuego:	baja inflamabilidad, (V-0) UL 94		Conforme a normativa europea 2002/95/EC ("RoHS")
- Estabilidad:	65°C, DIN 53400 / B		Conforme a certificación CSA-US
- Coeficiente de dilatación térmica:	5x10 ⁻⁵		

MATERIAL FUNDA ESPIRAL

PROPIEDADES	UNIDADES	VALOR	NORMA
A) GENERALES			
Densidades 23°C	Kg/m ³	922	ASTM D-1505
Punto Vicat	°C	94	ASTM D-1525
B) DEL FILM DE 200 mm			
Resistencia al impacto	g	700	ASTM D-1709
Resistencia al rasgado	Kn/m		ASTM D-1922
Dirección Máquina		10	
Dirección Transversal		30	
Resistencia a la tracción en el punto de fluencia	MPa		ASTM D-638/882
D.M.		11	
D.T.		11	
Resistencia a la tracción en el punto de rotura	MPa		ASTM D-638/882
D.M.		21	
D.T.		19	
Alargamiento en el punto de rotura	%		ASTM D-638/882
D.M.		550	
D.T.		650	
Brillo (Reflexión espectacular a 45)	%	55	ASTM D-2457

MATERIAL FUNDA EXTENSIBLE

PROPIEDADES	ENSAYO	RESULTADO
Flamabilidad	Propagación de la llama. IEC 684 Parte 2 Cláusula 26 Método B En posición vertical con cable	Sin ignición
	Ensayo de la llama. UL 1441 VW-1 En posición vertical con cable	Sin ignición
Resistencia a altas temperaturas	Flexión después de calentamiento IEC 684 Parte 2 Cláusula 13 48 horas a 400°C.	No se agrieta. El barniz de silicona desaparece.
Resistencia al frío	Flexión a baja temperatura IEC 684 Parte 2 Cláusula 14 a -15°C	No se agrieta
Resistencia a agentes químicos	Simulación de condiciones de trabajo	Excelente resistencia a los disolventes compatible con la mayoría de los barnices aislantes

ABRAZADERAS Y TACOS DE POLIAMIDA

PROPIEDADES

Composición: Poliamida 6.6
 Autoextinguible según UNE EN 60695-2-1/:97
 Inflamabilidad S/UL94:V2
 Punto máximo de temperatura (para un corto espacio de tiempo): +110°C
 Temperatura de fusión: +256°C
 Temperatura de uso: -40°C a +85°C
 Temperatura de montaje: -40°C a +80°C
 Resistencia a la tracción según norma EN 50146:00
 Absorción agua (24h) 1,2%
 Índice Límite de Oxígeno (LOI): 27%
 Rigidez dieléctrica: 50 kV/mm
 Cumplimiento de las normas IEC EN 60092-101, UL1565, ISO 4892

TERMOSTATO

CÓDIGO	DESCRIPCIÓN	MODO OPERACIÓN	
201921	Termostato regulable 0-60° azul	NO ("normally opened")	El termostato se cierra con la subida de temperatura
201922	Termostato regulable 0-60° rojo	NC ("normally closed")	El termostato se abre con la subida de temperatura
Certificados: Conforme a normas EN 55014-1-2, EN 61000-3-2, EN 61000-3-3 • Certificados RoHS y CE			
ESPECIFICACIONES			
Sensor	Bimetal termostático		
Tolerancia máxima	±4.0°C (4K)		
Histéresis	7°C±3K (12.6°F±5.4°F)		
Vida de servicio	100.000 ciclos		
Capacidad (carga máxima)	15A resistivo /2A inductivo @ 120 VAC 10A resistivo /2A inductivo @ 250 VAC DC 30W		
Carga mínima	20 mA (todos los voltajes)		
Conexiones	Terminal bipolar para AWG 14 max (2.5mm ²)		
Montaje	Clip para raíl DIN 35mm (EN 50022)		
Dimensiones	60x33x43mm		
Carcasa	Plástico, UL 94V-0		
Peso	40 gramos		
Grado de protección	IP20		
Temperatura de trabajo	de -20° a 80°C (de -4° a 176°F)		
Temperatura de conservación	de -45° a 80°C (de -49° a 176°F)		

PUENTES CONECTORES PIA

4.1 CARACTERÍSTICAS DEL MATERIAL

Material del cuerpo metálico: Cobre.

Material del cuerpo plástico: PC/ABS (policarbonato/acrilonitrilo butadieno estireno).

4.2 CARACTERÍSTICAS DEL MATERIAL - ELÉCTRICAS

CARACTERÍSTICA	VALORES
Temperatura de deflexión	80°C UL94-V0
GWFI (ensayo inflamabilidad hilo incandescente)	960°C/3,2mm ; 850°C/1mm
CTI ("comparative tracking index")	600V
Aislamiento	Categoría sobretensión III
Grado de polución	2
Grado de protección	IP20
Sección	10mm ²
Rigidez al pulso de tensión	≥4,5kV
Distancia de aire	>5,5mm
Distancia entre conductores	>5mm
Tensión máxima de operación	690 V AC
Grado cortocircuito	ICC 25kA - NH3 355A gC500V JM
Rigidez dieléctrica	>32 kV / mm
Intensidad máxima	63A

REGLETAS DE CONEXIÓN Y DISTRIBUCIÓN

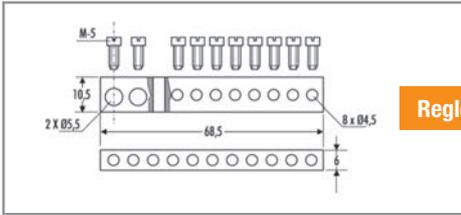

Regleta 8+2

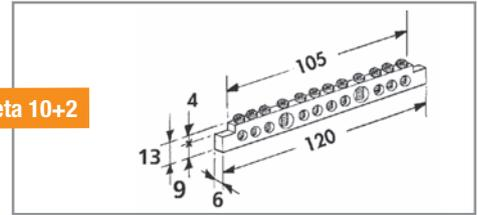

Regleta 10+2

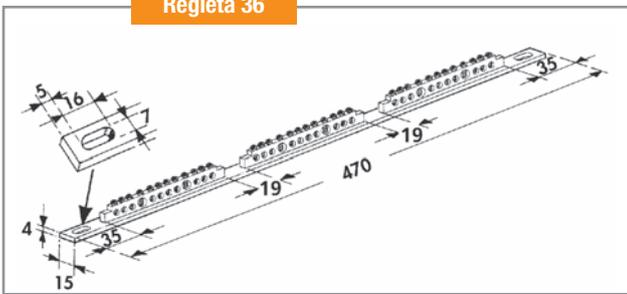

Regleta 36

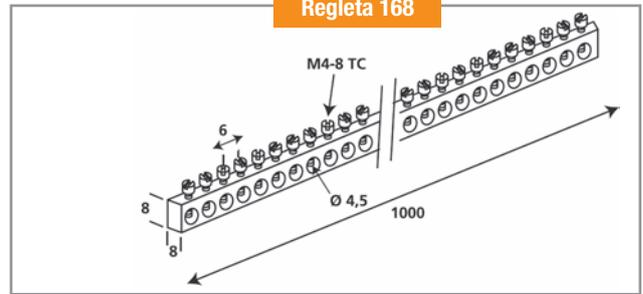

Regleta 168

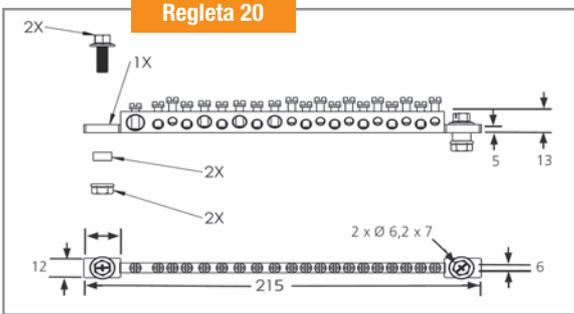

Regleta 20

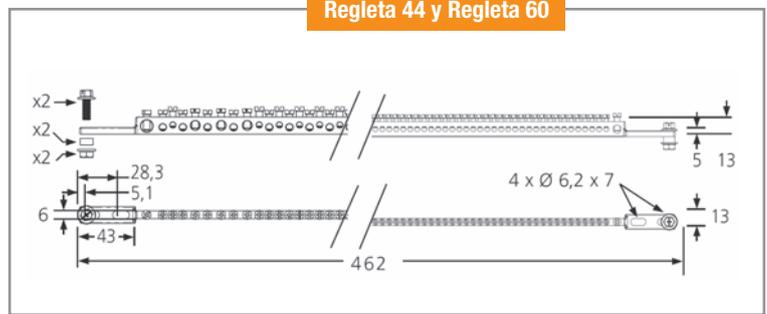

Regleta 44 y Regleta 60

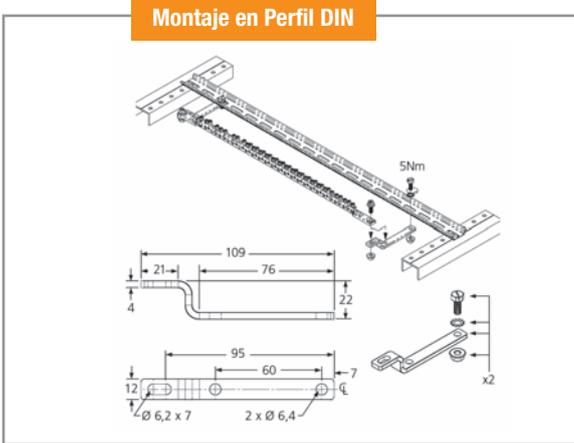

Montaje en Perfil DIN

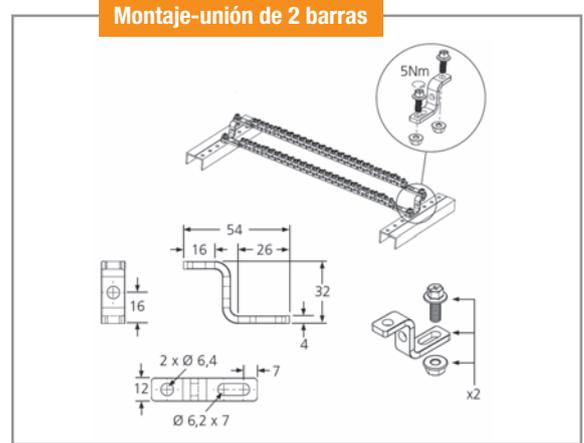

Montaje-uni3n de 2 barras

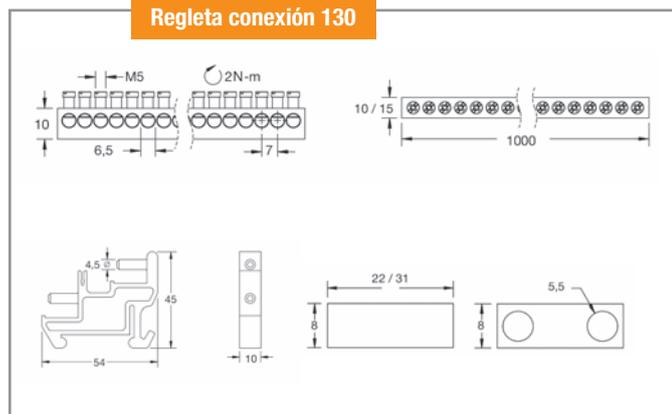

Regleta conexi3n 130

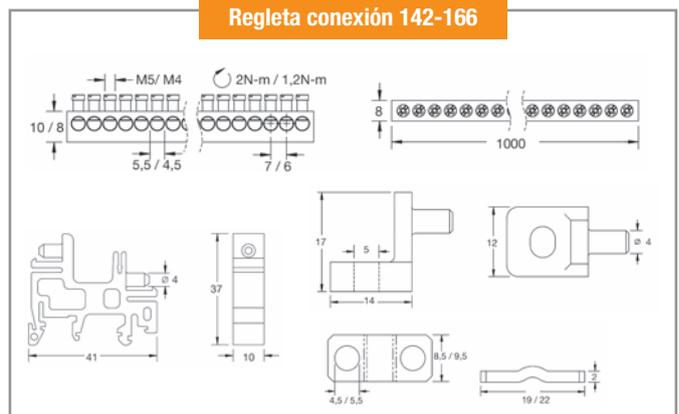

Regleta conexi3n 142-166

PICAS TOMA DE TIERRA

CARACTERÍSTICAS	UNIDAD DE MEDIDA	VALOR
Ángulo punta	°	60
Espesor cobre	µm (micras)	100
Diámetro acero	mm	14
Diámetro total	mm	14,2
Sección de acero	mm ²	153,93
Sección de cobre	mm ²	4,43
Sección total	mm ²	158,37
Resistividad del cobre a 20°C	Ω·m	1,7 E-8
Resistividad del acero a 20°C	Ω·m	2 E-7
Resistencia del cobre	Ω	5,76 E-3
Resistencia del acero	Ω	9,70 E-4
Resistencia final	Ω	8,3 E-4
Propiedades del acero empleado	• Composición química:	Certificaciones:
• Acero calibrado de calidad F1	• 0,13% C • 0,25% Si	• Fabricación según
• Dureza BRINELL: 180-200	• 0,5% Mn • < 0,04% P	norma UNE 202006
	• < 0,04% S	

CAJA SECCIONAMIENTO DE TIERRA

CARACTERÍSTICAS	NORMA APLICADA	VALOR
Grado de inflamabilidad	UNE-20672-2-1/1	960 °C
Resistencia al calor anormal y al fuego	UNE-EN 60695-2-1	690 °C
Tensión nominal		500 V
Rigidez dieléctrica entre partes activas		≥ 2.500 V
Rigidez dieléctrica entre partes activas y masa		≥ 3.750 V
Ensayo de onda de choque		10 kV
Resistencia al aislamiento	UNE-EN-60439-1	> 1kΩ/V
Grado de protección	UNE 20324	IP-55
Grado de protección al impacto	UNE-EN 50102	IK-08
Homologaciones		
• ENDESA DISTRIBUCIÓN. Referencia 6703461, CAJA CONEXIÓN COMPROB. MEDIDA RESIST. PaT.		

TAPAS, MARCOS Y ARQUETAS TERMOESTABLES

PROPIEDADES	UNIDAD	NORMA	VALOR
Alargamiento a la rotura	%	DIN 53455	650
Conductividad térmica	W/Km	DIN 52612	0,22
Coefficiente de dilatación térmica de 20°C a 50°C	m/m K		150-10-6
Coefficiente de Fricción			0,4
Densidad	g/cm ²	DIN 53479	0,91
Dureza a la bola	N/mm ²	DIN 53456	
Dureza "Shore"		DIN 53505	D73
Módulo de elasticidad	N/mm ²	DIN 53457	1300
Punto de fusión	°C	ASTM D789	164
Resistencia Superficial		DIN 53482	5·10 ¹³
Resistencia al impacto	KJ/m ²	DIN 53453	10
Carga de rotura		UNE-EN 1433:2002	A15
Resistencia a la tracción	N/mm ²	DIN 53455	33
Temperatura máxima de uso	°C	NORMAL	100
	°C	CON PUNTAS	140
Temperatura mínima de uso	°C		-10

MATERIAL POLICARBONATO

PROPIEDADES	UNIDADES	VALOR	NORMA APLICADA
AUTOEXTINGUIBILIDAD (8 GRADO DE SEVERIDAD)	-	960	UNE 0672 – 83 (2-1)
RESISTENCIA A LA FLEXIÓN	MPa	1000	DIN 53452
RESISTENCIA AL IMPACTO (CHARPY)	KJ/m ²	35	DIN 53453
RESISTENCIA A LA TRACCIÓN (LÍMITE ELÁSTICO)	%	600	DIN 53455
RESISTENCIA A LA TRACCIÓN (ROTURA)	MPa	700	DIN 53455
RESISTENCIA A LA PERFORACIÓN ELÉCTRICA	kV/cm	300	
IEC 243			
RESISTENCIA A LA TEMPERATURA	°C	135	-
PESO ESPECÍFICO	gr/cm ³	1,2	DIN 53479

MATERIAL POLIÉSTER SMC: PLANCHAS, ARQUETAS TT, TAPAS TM

Propiedades del material (poliéster SMC reforzado con fibra de vidrio):

PROPIEDADES	ESTANDAR	UNIDAD	VALOR	TOLERANCIA
Densidad	ISO 1183	gr/cm ³	1,75	±0,05
Contracción	ISO 2577	%	0,09	±0,05
Reactividad SMC	ISO 12114/I	s	98	±0,08
Color DE	MELPA 022	CIELab	<1	
Resistencia a la flexión	ISO 14125	MPa	>130	
Módulo de flexión	ISO 14125	MPa	>11.000	
Resistencia a la tracción		ISO 527-1	%	MPa
1,58 (límite elástico)	60 (rotura)		±15	
Resistencia al impacto Charpy	ISO 179	KJ/m ²	>45	
Contenido en vidrio	MELPA 005	%	19	±2
Gramaje	ISO 10352	gr/ m ²	5.000	±250
Factor de pérdidas dieléctricas a 1MHz	DIN 53483	tgδ	0,03	
Resistencia a la perforación eléctrica	DIN 5346	kV/cm	190	±10
Resistencia a la temperatura		°C	-50<x<150	
Constante dieléctrica relativa a 800Hz	DIN 53483		3,6	
Autoextinguibilidad	UNE 53315/ISO 1210		FH2	

Ensayos tapas TM-400

- Carga de rotura aplicada según norma UNE-EN 124-95. 60kN. Ensayo realizado por AIMME – Instit. Tecn. Metalmecánico.
- Grado de protección contra daños mecánicos según norma UNE 20324-93.

MATERIAL BAQUELITA

PROPIEDADES	NORMA	UNIDADES	VALOR
Densidad	ISO 1183/A	g/cm ³	aprox. 1,4
Resistencia flexión MD/TD	ISO 178	Mpa	140/100
Módulo elasticidad a flexión MD/TD	ISO 178	Mpa	16000/11000
Resistencia a tracción MD/TD	ISO 527	MPa	120/90
Resistencia a compresion perpendicular a los laminados	ISO 604	MPa	250
Resistencia aislamiento despues inmersión en agua	IEC 60167	Ohm	10 ⁹
Resistencia electrica a 23° en aceite perpendicular a los laminados (espesor 3mm)	IEC 60243	kV/mm	10
Resistencia dieléctrica a 23° en aceite paralelo a los laminados	IEC 60243	kV	30
Indice de tracking comparativo	IEC 60112		CTI 600
Absorción de agua (espesor 10mm)	ISO 62/1	mg	200
Resistencia de arco	DIN 53484 ASTM D495	sec	120

AISLADORES ALH LIBRES DE HALÓGENOS

CARACTERÍSTICAS TÉCNICAS					
<ul style="list-style-type: none"> • Libre de halógenos. • Auto-extinguible: UL 94 VO 		<ul style="list-style-type: none"> • Rango de temperaturas de trabajo: de -40°C a +130°C • Alta estabilidad de parámetros eléctricos y mecánicos 			
		Carac. eléctricas		Carac. mecánicas	
Código	Descripción	Alterna (V)	Continua (V)	Fuerza de Tensión (daN)	Fuerza de Torsión (daN)
310801	ALH-25/6	1.000	1.500	300	160
310802	ALH-30/6	1.000	1.500	600	300
310803	ALH-35/6	1.000	1.500	1.100	500
310804	ALH-40/6	1.000	1.500	1.100	800
310811	ALH-30/8	1.000	1.500	600	300
310812	ALH-35/8	1.000	1.500	1.100	800
310813	ALH-40/8	1.000	1.500	1.100	800
310814	ALH-45/8	1.000	1.500	1.100	650
310821	ALH-35/10	1.000	1.500	1.100	800
310822	ALH-40/10	1.000	1.500	1.100	450
310823	ALH-45/10	1.000	1.500	1.800	700
310824	ALH-50/10	1.000	1.500	2.000	1.000
310825	ALH-60/10	1.000	1.500	2.200	1.000
310831	ALH-60/12	1.000	1.500	2.200	1.000
310832	ALH-70/12	1.000	1.500	3.000	1.600

AISLADORES ALP

CARACTERÍSTICAS TÉCNICAS						
<ul style="list-style-type: none"> • Rango de temperaturas de trabajo: de -30°C a +120°C • Humedad: Absorción de agua (24h a 23°C) 0,87% 						
		Caract. eléctricas		Caract. mecánicas		
Código	Descripción	Alterna (V)	Continua (V)	Fuerza de Tensión (daN)	Fuerza de Torsión (daN)	Par de Torsión (Nm)
310701	ALP-25/6	660	500	420	220	42
310702	ALP-30/8	660	500	420	220	42
310703	ALP-35/8	750	900	980	375	60
310704	ALP-40/8	750	900	980	375	60
310705	ALP-40/10	750	900	980	375	60
310706	ALP-45/8	750	1000	980	375	60
310708	ALP-50/10	750	1000	1150	925	110
310711	ALP-50/10+2x8	750	1000	1150	925	110
310712	ALP-50/12+2x10	750	1000	1150	925	110
310713	ALP-60/10	750	1000	1220	925	125
310717	ALP-75/10	750	1000	1220	925	125

ADHESIVO TUBO TERMO-RETRÁCTIL 1000V

PROPIEDADES	UNIDADES	VALOR	MÉTODO ENSAYO
Resistencia a la perforación	kV/mm	>14	DIN 53 481
Absorción de agua	%	<0,2	DIN 53 475
Punto de reblandecimiento	°C	100	DIN 52 011
Resistencia al despellejado (PE)	N/25mm	>110	DIN 53 539
Resistencia al cobre	no corrosivo	ASTM D2671	

MATERIAL TUBO TERMO-RETRÁCTIL 1000V

PROPIEDADES	UNIDADES	VALOR	MÉTODO ENSAYO
Temperatura de uso permanente	°C	-55 a + 120	IEC 216
Temperatura de contracción	°C	>110	
Contracción longitudinal	%	<10	ASTM D2672
Alargamiento de rotura	%	450	ASTM D 638
Módulo de elasticidad	N/mm ²		42
DIN 53 455			
Densidad	g/cm ³	1,05	
Dureza		shore d	
50			
Resistencia a la tracción	N/mm ²		>14
ASTM D 638			
Resistencia a la perforación	Kv/mm	>18	ASTM D 149
Resistencia específica de la parte inferior	Ohm x cm	>1014	ASTM D 257
Resistencia al cobre	no corrosivo	ASTM D2671	
Absorción de agua	%	<0,1	DIN 53 475

FUNDA POLIOLEFINA

Certificaciones: UL E180908, cRU, SONY Green Partner.

Material: Poliolefina irradiada y reticulada. Libre de halógenos. Colores: azul, negro, gris, marrón, amarillo/verde.

CARACTERÍSTICA	VALOR NOMINAL
Temperatura de contracción	90°C
Temperatura de utilización	Hasta 125°C
Ratio de contracción	2:1
Cambio longitudinal	≤ 5%
Resistencia a la tracción	≥ 10,4MPa
Límite de alargamiento	≥ 200%
Envejecimiento térmico	168h a 158°C ± 1°C
Resistencia a la tracción (tras envejecimiento técnico)	≥ 7,3MPa
Límite de alargamiento (tras envejecimiento técnico)	≥ 100%
Resistividad de volumen	≥ 1014 Ω.cm
Rigidez dieléctrica 1 min. AC2500V	Sin descarga
Shock térmico	Sin rotura
Combustibilidad	VW-1

TUBO FIBRA DE VIDRIO-POLIURETANO

NORMAS	CARACTERÍSTICAS
<ul style="list-style-type: none"> • Conforme con la directiva RoHS 2002/95/CE • NF EN 60684-1 (10-2003) • NF EN 60684-2 (01-1998) <p>modificado por las enmiendas NF EN 60684-2/A1 (12/2003). NF EN 60684-2/A2 (05/2006)</p> <ul style="list-style-type: none"> • NF EN (CEI) 60684-3 hoja 409 (12/1999) • Opción: <i>UL 1441 1 CSA C22.2 W198.3</i> <p><i>(Pasa la prueba de no propagación de la llama, muestra horizontal N° de informe: UZKX2-E302796)</i></p>	<ul style="list-style-type: none"> • Clase de temperatura: F • Temperatura en servicio continuo: de -30°C + 155°C. Puntas + 185°C (algunas horas) • Rigidez dieléctrica: de 3 a 1 O kV • Tubo sin halógeno • Hasta el doble flexible que nuestra referencia SEP-R, según la norma N F EN 60684-2 § 18 • Dureza del barniz: 60 Shore A • Resistencia a la llama: combustible, pero subsistencia de la fibra de vidrio • Buena resistencia mecánica • Buena resistencia a los hidrocarburos • Resistencia a los aceites de los transformadores: pasa el test según la Norma UTEC 93641 • Buena compatibilidad con los barnices de misma clase • Buen comportamiento al soldador • Buen comportamiento a los combustibles líquidos: no hay descomposición • Estanco • Flexible

TUBO FIBRA DE VIDRIO-SILICONA

NORMAS	CARACTERÍSTICAS
<ul style="list-style-type: none"> • Conforme con la directiva RoHS 2011/65/EU • F1 y 12 según las normas NF F 16-101/16-102 y STM S-001 • NF EN 60695-2-10 (05-2001) • NF EN 60695-2-11 (07-2001) • NF EN 60684-1 (10-2003) • NF EN 60684-2 (07-2012) • NF EN (CEI) 60684-3 hojas 400 a 402 (02/2003) • Opción: <i>Homologación UL 1441/CSA C22.2 N°198.3</i> <p><i>SCS UL: Pasa la prueba de no propagación de la llama UL/VW7, muestra vertical</i> <i>N° de informe: UZIQ2-E235042</i> <i>SCS1kV: Tubo de fibra de vidrio barnizado caucho de silicona Grado A, 200°C, 600 Volts</i> <i>N° de informe: UZFT2/8-E794299</i></p>	<ul style="list-style-type: none"> • Clase de temperatura: C • Temperatura en servicio continuo: de -60°C a +250°C Puntas a +290°C (algunas horas) • Rigidez dieléctrica: de 1,5 a 15kV • Resistencia a la llama: auto-extinguible • Buena resistencia mecánica • Buena resistencia a los UV • Resistente a los aceites de los transformadores • Buena compatibilidad con los barnices de misma clase • Buen comportamiento al soldador • Buen comportamiento a los combustibles líquidos: no hay descomposición • Sin halógeno • Estanco • Muy flexible

AUMENTADOR DE CONDUCTIVIDAD

PROPIEDADES
<ul style="list-style-type: none"> • Producto líquido listo para aplicar directamente al electrodo de tierra • Una vez añadido se obtienen resultados de inmediato. Produce descensos de resistividad de entre el 50% y 90% del valor original. • No se requiere de ningún mantenimiento adicional. • Se recomienda medir la resistencia a tierra de la instalación al menos una vez al año en la época más seca y reparar en caso de necesidad. • Se recomienda que el electrodo a tratar esté accesible para poder aplicar el producto. • Producto perdurable en el tiempo. • Producto no contaminante ni peligroso.

MINICANAL

CARACTERÍSTICAS GENERALES

- Material: PVC M1 RAL 9016. Aislante.
- Modo de fijación: sobre pared o techo, con tornillo.
- Lugar de instalación previsto: interiores.
- Tapa de protección desmontable.
- Directiva 2006/95/CE – Real Decreto 7/1988
- REBT 2002: Reglamento de baja tensión
- Conformidad UNE EN 50085-1

PARÁMETRO	VALOR
Grado protección	IP30
Resistencia al impacto	IK07
Tensión de aislamiento	1000V
Rigidez dieléctrica	2,5kV
Resistencia de aislamiento	> 10MΩ (500V)
Resistencia al calor anormal	65°C (Hilo incandescente)
Resistencia a la temperatura por presión de bola	70°C Estabilidad dimensional
Temperatura: -25°C / +85°C	Humedad relativa: 100% HR

SOPORTE HORIZONTAL

CÓDIGO		KG
090210	Soporte Horizontal 100	300
090211	Soporte Horizontal 150	250
090212	Soporte Horizontal 200	230
090213	Soporte Horizontal 300	200
090214	Soporte Horizontal 400	190
090215	Soporte Horizontal 500	170
090216	Soporte Horizontal 600	160

SOPORTE OMEGA

CÓDIGO		KG
090120	Soporte Omega 100	100
090121	Soporte Omega 150	90
090122	Soporte Omega 200	90
090123	Soporte Omega 300	50
090124	Soporte Omega 400	37

SOPORTE TECHO OMEGA

CÓDIGO		KG
090410	Soporte techo Omega 100	85
090412	Soporte techo Omega 200	50
090413	Soporte techo Omega 300	30
090414	Soporte techo Omega 400	23

SOPORTES GRANDES CARGAS

	CASO DE CARGA A			CASO DE CARGA B			CASO DE CARGA C			CASO DE CARGA D		
L(mm)	F de la tensión admisible (N)	F de la deflexión admisible (N)	Carga admisible (N)	F de la tensión admisible (N)	F de la deflexión admisible (N)	Carga admisible (N)	F de la deflexión admisible (N)	F de la deflexión admisible (N)	Carga admisible (N)	F de la tensión admisible (N)	F de la deflexión admisible (N)	Carga admisible (N)
200	4764	9482	4764	4764	12642	4764	2382	16085	2382	2382	4741	2382
300	3176	4214	3176	3176	5619	3176	1588	7149	1588	1588	2107	1588
400	2117	1873	1873	2117	2497	2117	1059	3177	1059	1059	936	936
600	1588	1054	1054	1588	1405	1405	794	1787	794	794	527	527
1000	1270	674	674	1270	899	899	635	1144	635	635	337	337

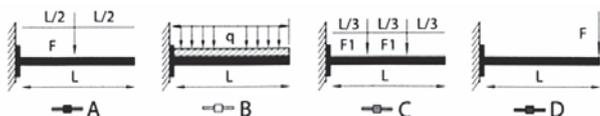

COTAS SOPORTES REFORZADOS

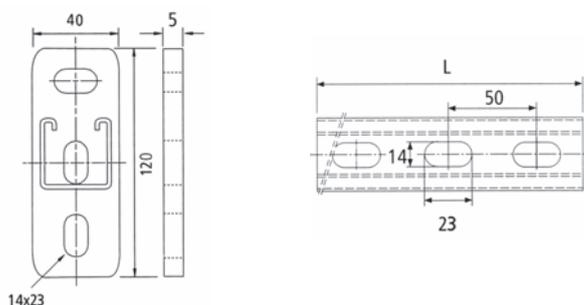

TODOS LOS VALORES EN NEWTONS

BANDEJA DE REJILLA

MATERIAL:

Varilla de acero con Calidad C4D, según Norma UNE EN 10016-2/3

Recubrimiento superficial:

Zincado electrolítico, según Norma UNE EN 12329:01

Galvanizado en caliente, según Norma UNE EN ISO 1461

- **CUMPLIMIENTO DE LA NORMA UNE EN 61537-2002 (CEI 61537)**

Sistemas de bandejas para la conducción de cables

TEMPERATURA DE SERVICIO: -40°C a +120°C

CARGA DE TRABAJO ADMISIBLE: Ver apartado de "Datos técnicos para el cálculo de cargas", del presente catálogo.

RESISTENCIA AL IMPACTO: 20 J (equivalente al grado IK- 10 según UNE- EN 50102:1996)

PROPIEDADES ELÉCTRICAS: ELÉCTRICAMENTE CONDUCTOR

- **DECLARACIÓN DE CONFORMIDAD:** CE MARCADO CE. CUMPLIMIENTO DE LA DIRECTIVA EUROPEA BT 73/23/CEE. CONFORMIDAD A LA NORMA UNE- EN 61537:2002 (CEI 61537), CON CLASIFICACIÓN:

COMPONENTE METÁLICO.

NO PROPAGADOR DE LA LLAMA.

SISTEMA CON CONTINUIDAD ELÉCTRICA.

COMPONENTE ELÉCTRICAMENTE CONDUCTOR

TEMPERATURA MÍNIMA: -40°C

TEMPERATURA MÁXIMA: +120°C

ÁREA LIBRE DE LA BASE: Clasificación Z

RESISTENCIA AL IMPACTO HASTA 20J.

- **ENSAYO DE REACCIÓN AL FUEGO**

Clasificación: M0 Según UNE 23727-90

- **PROTECCIÓN CONTRA DAÑOS MECÁNICOS**

Resultado del ensayo: Clasificación Grado IK-10

Según UNE EN 50102-96

- **ENSAYO DE CARGA SOBRE BANDEJAS DE REJILLA**

Ensayo de Carga de Trabajo Admisible según UNE EN 61537-2002 (CEI 61537)

- **ENSAYO DE CONTINUIDAD ELÉCTRICA EN BANDEJAS DE REJILLA**

Ensayo satisfactorio, según Norma UNE EN 61537-2002 (CEI 61537), en el que la Bandeja de Rejilla, obtiene la clasificación: "Sistema de Bandejas con características de continuidad eléctrica".

BANDEJAS METÁLICAS

MATERIAL:

Chapa de Acero bajo en carbono, Galvanizado en continuo "sendzimir". Chapa de Acero bajo en carbono para el acabado Galvanizado en Caliente por inmersión en zinc fundido según Norma UNE EN ISO 1461.

- **CUMPLIMIENTO DE LA NORMA UNE EN 61537-2002 (CEI 61537)**

"Sistemas de bandejas para la conducción de cables":

TEMPERATURA DE SERVICIO: -40°C a +120°C

CARGA DE TRABAJO ADMISIBLE: Ver apartado de "Datos técnicos para el cálculo de cargas", del presente catálogo.

RESISTENCIA AL IMPACTO: 20 J (equivalente al grado IK-10 según UNE-EN 50102:1996)

PROPIEDADES ELÉCTRICAS: ELÉCTRICAMENTE CONDUCTOR

- **CUMPLIMIENTO DE LA NORMA UNE EN 50085-1-1997**

"Sistemas de canales para cables en instalaciones eléctricas":

TEMPERATURAS DE SERVICIO: -40°C a +120°C

RESISTENCIA AL IMPACTO: MUY FUERTE (20J)

PROPIEDADES ELÉCTRICA: CON CONTINUIDAD ELÉCTRICA

RESISTENCIA A LA PROPAGACIÓN DE LA LLAMA: NO PROPAGADOR

PROTECCIÓN CONTRA LA PENETRACIÓN DE SÓLIDOS Y LÍQUIDOS (*)

Bandejas perforadas con tapa: Grado IP2X

Bandejas ciegas con tapa: Grado IP64

Ensayos realizados según UNE 20324:93 (EN 60529)

(*) Aplicable únicamente al cierre Tapa- Tramo de Bandeja

* **Importante:** Las bandejas metálicas perforadas y ciegas, cumplen con la norma UNE EN 50085-1 siempre y cuando sean instaladas con tapa.

- **DECLARACIÓN DE CONFORMIDAD:** CE MARCADO CE. CUMPLIMIENTO DE LA DIRECTIVA EUROPEA BT 73/23/CEE.

COMPONENTE METÁLICO.

NO PROPAGADOR DE LA LLAMA.

SISTEMA CON CONTINUIDAD ELÉCTRICA.

COMPONENTE ELÉCTRICAMENTE CONDUCTOR

CON RECUBRIMIENTO

TEMPERATURA MÍNIMA: -40°C

TEMPERATURA MÁXIMA: +120°C

% PERFORACIÓN DE LA BASE:

Para Bandejas Ciegas: A

Para Bandejas Perforadas: B

RESISTENCIA AL IMPACTO HASTA 20J.

- **ENSAYO DE REACCIÓN AL FUEGO**

Clasificación: M0 Según UNE 23727-90

- **PROTECCIÓN CONTRA DAÑOS MECÁNICOS**

Resultado del ensayo: Clasificación Grado IK- 10

Según UNE EN 50102-96

- **PROTECCIÓN CONTRA LA PENETRACIÓN DE SÓLIDOS Y LÍQUIDOS**

Resultados del ensayo: Bandejas perforadas con tapa: Grado IPX2

Bandejas ciegas con tapa: Grado IP64

- **ENSAYO DE CARGA SOBRE BANDEJAS METÁLICAS**

Ensayo de Carga de Trabajo Admisible según UNE EN 61537-2002 (cei 61537)

- **ENSAYO DE CONTINUIDAD ELÉCTRICA EN BANDEJAS METÁLICAS**

Ensayo satisfactorio, según Norma UNE EN 61537-2002 (CEI 61537), en el que las Bandejas Metálicas, obtiene la clasificación : "Sistema de Bandejas con características de continuidad eléctrica"